



SOUND & LIGHT

SOLUTIONS

SYNQ
AUDIOPHONY
AUDIOPHONY-PA
BRITEQ
CONTEST
CONTESTAGE
JB-SYSTEMS
HILEC
JVCASE

2020 — EDITION

BEGLEC
HITMUSIC

EDITO

We are pleased to present you our new 2020 catalogue.

It's already 3 years that BEGLEC and HITMUSIC have joined forces!

This alliance is positively reflected in our new global offer, you can see that each brand specializes and that our product lines are more and more clear.

Whether you are a shop, an installer, a service provider or a distributor, our brands bring you more and more solutions adapted to your needs.

The BEGLEC HITMUSIC group is a team of 65 people working together!

Enjoy your reading!

Luc de BAUW
Director BEGLEC - Partner

Pierre DENJEAN
President HITMUSIC - Partner

Marc de BAUW
Associate



WHERE ARE WE?



9

EXCLUSIVE BRANDS

65

PEOPLE AT YOUR SERVICE

1830

PRODUCTS REFERENCED IN THIS CATALOGUE

HIT MUSIC SAS

Parc d'Activités Cahors Sud
En Teste
46230 FONTANES
France
Tel. : +33 (0)5 65 21 50 00
contact@hitmusic.eu

OPENING HOURS

Monday → Friday
9:00 to 12:00 & 13:15 to 17:15

BEGLEC NV

't Hofveld 2c
Industriezone "Gosset"
B-1702 Groot-Bijgaarden
Belgique
Tel. : +32 (0)2 481 70 70
orders@beglec.com

OPENING HOURS

Monday → Friday
8:30 to 12:15 & 13:00 to 17:00

SUMMARY

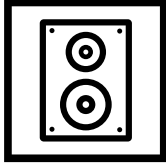

P6
SOUND

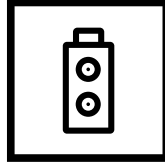

P74
PORTABLE SOUND



P82
COMMERCIAL AUDIO

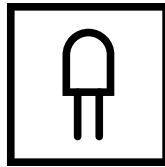

P112
LIGHT INTEGRATION



P134
LIGHT

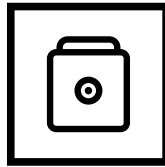

P206
EFFECT MACHINES



P216
FLIGHT-CASES

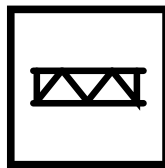

P224
TRUSS

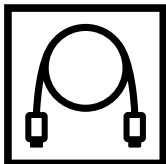

P264
ACCESSORIES

09:49 Jeu. 16 janv.

Audiophony
EQUIPEMENTS

DEVICE
SCENES

OFFLINE/DEMO



HOME

SCENES

SETUP

REV OUTPUT

CH1 2.4

CH2 6.9

CH3 6.9

CH4 6.7

CH5/6 6.1

CH7/8 3.6

name 0 10

name 0 10

name 0 10

name 0 10

name 0 10

name 0 10

1 REV-PLATE

2 REV-PLATE2

3 REV-ROOM

4 REV-ROOM2

5 REV-HALL

6 REV-HALL2

7 CHROUS

8 FLRANGE

-7.1dB

REV

MASTER

10 5 0 -5 -10 -20

10 5 0 -5 -10 -20 -40



SOUND

COLUMN ARRAY ILINE
MOJO SOUND SYSTEM
ACTIVE SPEAKERS
PASSIVE SPEAKERS
SUBWOOFERS
AMPLIFIERS
SOUND PROCESSING
MIXING DESKS
CD PLAYERS
TURNTABLES
MICROPHONES
UHF410 RANGE
GO RANGE
HEADPHONES

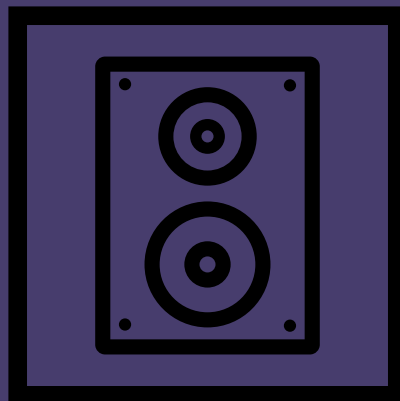

ILINE COLUMN ARRAY

Complete iLINE COLUMN ARRAY set



“Column Array” column systems

Aesthetically pleasing, the system comes with 2 families of columns. One for installation with columns iLINE23, iLINE43, iLINE83, and the other for stage performance with the iLINE83B model.

They are linked and powered by an active subwoofer, the iLINEsub12A which embeds a double amplification of 700W/5 Ohms in class D for the columns and 700W/4 Ohms for the lower part because we can also add the iLINEsub12A as a reinforcement, which is the passive version of the subwoofer.



Go to dedicated website :
iline-series.audiophony.com

Modulate your desires.

Whether for mobile or fixed use, the system answers all your problems.

The system offers multiple possible combinations, for example, 2 columns, 1 subwoofer or 2 subwoofers, 2 columns, etc.

Once controlled by an active subwoofer, the iLINEsub12P passive subwoofers can supply the satellites for numerous configurations.



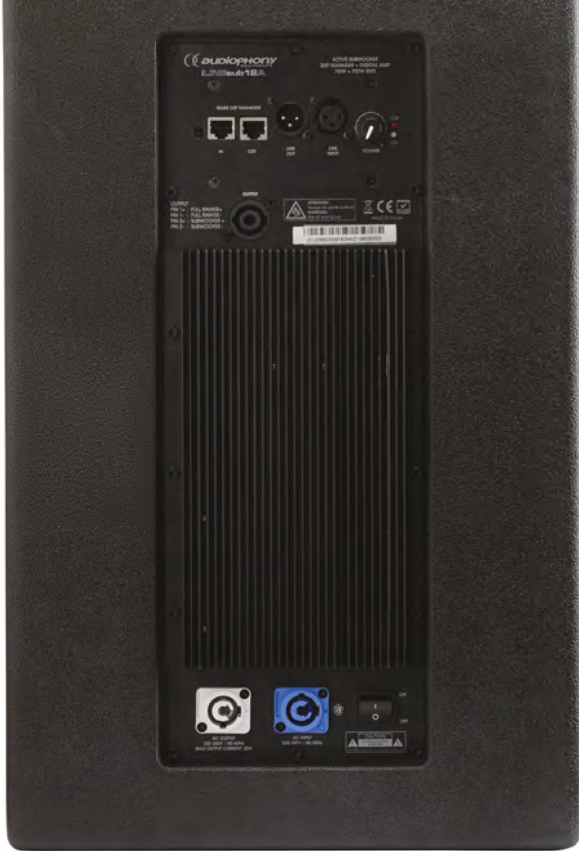

A system that travels well.

Lightweight and robust, the subwoofers are made of a very resistant wood, Finnish birch multi-ply plywood with a protective polyurethane resin coating, which is very resistant to scratches.

You can transport your entire iLINE system anywhere.

Touch the power, that's all!

If you want to touch the system's sound settings, an "iLINEbox" USB to RJ45 converter is sold separately. This box is needed if you want to adjust the built-in DSP.

The native DSP is preset to factory settings in order to ensure optimal system behaviour.



Only compatible with Windows

Available in black or white finish for service or installation.



ILINE COLUMN ARRAY

Discover the different configurations available to purchase.



iLINE
Stereo configuration 2.1 - 1020W RMS

Code : H10879 1999 €^{Incl. VAT}



- 2x iLINE83 (H10756)
- 2x iLINEsub12A (zH10761)
- 1x iLINEbox (H10762)
- 2x CAB-200 (H8245)
- 2x CSP215/6 (H9841)



iLINE
Mono configuration 510W RMS

Code : H10880 999 €^{Incl. VAT}



- 1x iLINE83B (H10758)
- 1x iLINEspace60 (H10759)
- 1x iLINEsub12A (H10761)
- 1x iLINEbox (H10762)



iLINE
Stereo configuration 2040W RMS

Code : H10881 2999 €^{Incl. VAT}



- 4x iLINE83B (H10758)
- 2x iLINEsub12P (H10763)
- 2x iLINEsub12A (H10761)
- 2x iLINEcord60 (H10764)
- 1x iLINEbox (H10762)



iLINE
Mono configuration 1020W RMS

Code : H10882 1799 €^{Incl. VAT}



- 2x iLINE83B (H10758)
- 1x iLINEspace60 (H10759)
- 1x iLINEbase (H10760)
- 1x iLINEsub12P (H10763)
- 1x iLINEsub12A (H10761)
- 1x iLINEcord60 (H10764)
- 1x iLINEbox (H10762)
- 1x CSP215/3 (H9840)

The RJ45 cord that connects the iLINEbox to the iLINEsub12A is not supplied.

See the LINK-RJ cords in accessories section
Available in multiple lengths





iLINE

Stereo installation combination - 2680W RMS

Code : H10883

4499 €Incl. VAT



- 8x iLINE83 (H10756)
- 8x iLINE83sup (H10757)
- 2x iLINEsub12P (H10763)
- 2x iLINEsub12A (H10761)
- 2x iLINEcord60 (H10764)
- 1x iLINEbox (H10762)
- 2x CSP215/3 (H9840)



iLINE

Stereo installation combination - 940W RMS

Code : H10884

2099 €Incl. VAT



- 4x iLINE43 (H10754)
- 4x iLINE24sup (H10773)
- 2x iLINEsub12A (H10761)
- 1x iLINEbox (H10762)



iLINE

Mono installation combination - 510W RMS

Code : H10885

1199 €Incl. VAT



- 4x iLINE23 (H10752)
- 4x iLINE23sup (H10753)
- 1x iLINEsub12A (H10761)
- 1x iLINEbox (H10762)



ILINE COLUMN ARRAY



iLINE83B
160W @ 16 Ohms column with 8 3-inch speakers - with stackable connector base

Code : H10758 249€^{Incl. VAT}



iLINE83
160W @ 16 Ohms column with 8 3-inch speakers for installation

Code : H10756 249€^{Incl. VAT}



iLINE83sup
Wall bracket for iLINE83 column

Code : H10757 39€^{Incl. VAT}





iLINE43
80W @ 8 Ohms column with 4 3-inch speakers for installation

Code : H10754 149€^{Incl. VAT}





iLINE43sup
Wall bracket for iLINE43 column

Code : H10755 35€^{Incl. VAT}

iLINE23
40W @ 16 Ohms column with 2 3-inch speakers for installation

Code : H10752 99€^{Incl. VAT}



iLINE23sup
Wall bracket for iLINE23 column

Code : H10753 29€^{TT}



iLINE24sup
Adjustable wall bracket for iLINE23 and iLINE43

Code : H10773 69€^{TT}



	iLINE23	iLINE43	iLINE83	iLINE83B	iLINEsub12A	iLINEsub12P
Power	40W RMS / 80W Max	80W RMS / 160W Max	160W RMS / 320W Max	160W RMS / 320W Max	700+700 W RMS / 4Ω	400W RMS / 800W Max
Frequencies	135 Hz / 17 kHz	135 Hz / 17 kHz	135 Hz / 17 kHz	135 Hz / 17 kHz	50 Hz / 200 Hz	50 Hz / 200 Hz
Sensitivity	89 dB / 108 dB max	92 dB / 114 dB max	95 dB / 120 dB max	95 dB / 120 dB max	96 dB / 124 dB max	96 dB / 125 dB max
Impedance	16Ω	8Ω	16Ω	16Ω	8Ω	8Ω
Speakers	2x3"	4x3"	8x3"	8x3"	12"	12"
Dispersion HxV	115° / 20°	115° / 20°	115° / 20°	115° / 20°	-	-
Dimensions	110x180x148 mm	110x350x148 mm	110x690x148 mm	110x770x148 mm	350x515x490 mm	350x515x490 mm
Weight	2.2 Kg	4 Kg	7.6 Kg	7.6 Kg	23.5 Kg	22 Kg



iLINEsub12P
12-inch passive subwoofer - 400W - 8 Ohms

Code : H10763 379€^{Incl. VAT}



iLINEsub12A
12-inch active subwoofer 700W + 700W with built-in DSP

Code : H10761 599€^{Incl. VAT}



iLINEspace60
Increase height by 60cm for iLINE83B with stackable connector base

Code : H10759 89€^{Incl. VAT}



iLINEbase
Floor bracket for iLINE83B and iLINEspace60

Code : H10760 119€^{Incl. VAT}



iLINEcord60
Speakon cord/Speakon 60cm for iLINE series

Code : H10764 12€^{Incl. VAT}



iLINEbox
USB → RJ45 converter for DSP of iLINEsub12A

Code : H10762 29€^{Incl. VAT}



iLINEbag
Carrying bag for 2 iLINE 8 HP columns or 2 iLINEspace 60

Code : H10767 59€^{Incl. VAT}



iLINEcov
Protective cover for iLINE series subwoofers

Code : H10768 69€^{Incl. VAT}



More information on
www.iline-series.audiophony.com

ILINE COLUMN ARRAY



iLINE83Bw
160W @ 16 Ohms column with 8 3-inch speakers - with stackable connector base

Code : H10939 259€^{Incl.VAT}



iLINE83w
160W @ 16 Ohms column with 8 3-inch speakers for installation

Code : H10938 259€^{Incl.VAT}



iLINE83sup/w
Wall bracket for iLINE83 column

Code : H10940 45€^{Incl.VAT}



iLINE43w
80W @ 8 Ohms column with 4 3-inch speakers for installation

Code : H10936 159€^{Incl.VAT}



iLINE43supw
Wall bracket for iLINE43 column

Code : H10937 35€^{Incl.VAT}



iLINE23w
40W @ 16 Ohms column with 2 3-inch speakers for installation

Code : H10934 99€^{Incl.VAT}



iLINE23supw
Wall bracket for iLINE23 column

Code : H10935 29€^{Incl.VAT}



iLINE24supw
Adjustable wall bracket for iLINE23 and iLINE43

Code : H10945 69€^{Incl.VAT}



	iLINE23w	iLINE43w	iLINE83w	iLINE83Bw	iLINEsub12Aw	iLINEsub12Pw
Power	40W RMS / 80W Max	80W RMS / 160W Max	160W RMS / 320W Max	160W RMS / 320W Max	700+700 W RMS / 4Ω	400W RMS / 800W Max
Frequencies	135 Hz / 17 kHz	135 Hz / 17 kHz	135 Hz / 17 kHz	135 Hz / 17 kHz	50 Hz / 200 Hz	50 Hz / 200 Hz
Sensitivity	89 dB / 108 dB max	92 dB / 114 dB max	95 dB / 120 dB max	95 dB / 120 dB max	96 dB / 124 dB max	96 dB / 125 dB max
Impedance	16Ω	8Ω	16Ω	16Ω	8Ω	8Ω
Speakers	2x3"	4x3"	8x3"	8x3"	12"	12"
Dispersion HxV	115° / 20°	115° / 20°	115° / 20°	115° / 20°	-	-
Dimensions	110x180x148 mm	110x350x148 mm	110x690x148 mm	110x770x148 mm	350x515x490 mm	350x515x490 mm
Weight	2.2 Kg	4 Kg	7.6 Kg	7.6 Kg	23.5 Kg	22 Kg



iLINEsub12Pw
12-inch passive subwoofer - 400W - 8 Ohms

Code : H10944 399€^{Incl. VAT}



iLINEsub12Aw
12-inch active subwoofer 700W + 700W with built-in DSP

Code : H10943 649€^{Incl. VAT}



iLINEspace60w
Increase height by 60cm for iLINE83B with stackable connector base

Code : H10942 89€^{Incl. VAT}



iLINEbasew
Floor bracket for iLINE83B and iLINESPACE60

Code : H10941 119€^{Incl. VAT}



iLINEcord60
Speakon cord/Speakon 60cm for iLINE series

Code : H10764 12€^{Incl. VAT}



iLINEbox
USB → RJ45 converter for DSP of iLINEsub12A

Code : H10762 29€^{Incl. VAT}



iLINEbag
Carrying bag for 2 iLINE 8 HP columns or 2 iLINEspace 60

Code : H10767 59€^{Incl. VAT}



iLINEcov
Protective cover for iLINE series subwoofers

Code : H10768 69€^{Incl. VAT}



More information on
www.iline-series.audiophony.com

MOJO1042APP

All in one active systems with mixer and app

Compact, light, powerful.

The MOJO1042APP is a concentrate of technology and innovation. It is a modular triphonic system with a power of 1020 W for a weight of only 18 Kg. It is equipped with a complete 5-way control mixer, Bluetooth®. DSP multi-effect, integrated in the cabinet with all the standards of connectivity for professional and consumer use.

Flexibility.

Our very smart system allows you to easily amplify and connect satellites directly onto the subwoofer, without any linking cable. This is only one of many possibilities to configure your MOJO1042APP sound system according to the location, audience, mono or stereo needs, and other parameters thanks to the supplied accessories.



View of the new mixer.





NEW

MOJO1042APP
Syst actif 2.1 - 1020W + DSP + App

Code : H10982 779€^{Incl. VAT}

audiophony
EQUIPMENTS



COV-MOJO1042APP
Travel bag + trolley for MOJO1042APP

Code : H10350 109€^{Incl. VAT}

audiophony
EQUIPMENTS

Power: 160 W max. (x2) the satellites + 700W max. the cabinet
Frequency response: 50Hz - 22KHz
SPL max. (@1m) : 120dB
Boomer: 4.75" for the satellite + 1 x 10" for the subwoofer
Tweeter: 1" compression
Dispersion : 90° x 45° (HxV)
Connectors : - CH1/4 : Combo XLR/Jack Micro/Guitar/Line - CH5/6 : Ligne Jack 6.35 L/R + RCA - CH7/8 : Jack 3.5 stéréo AUX + Bluetooth®
Settings : - Volume - DSP and contour per channel - Cabinet volume - Balance - Master
Multi-effects DSP: Reverb Plate/Plate2/Room/Room2/Hall/Hall2/Chorus/Flange.
IPAD app «MOJControl» level control, Parametric EQ, Multi-effects, and Compressor per channel, Graphic output EQ, Master, Balance, SUB Level.
Dimensions : (225 x 140 x 110 mm) x 2 for the satellites, 345 x 450 x 400 mm for the cabinet.
Net Weight: 3.8 Kg + 14.5 Kg

Ergonomic and smart.

We reserved storage compartments in the back of the subwoofer for the two satellites, ensuring you a safe and very handy transport.



MojoControl.

The MojoControl app for Apple iPad allows you to take control of the system's mixer.

You can set and customize each channel, adjust the curve with the parametric equalizer, choose the type of effect and record scenes.



THE MOJO RANGE



MOJO1200LINE

Active subwoofer and column system with mixer and 1 Bluetooth® input

Code : H10992

699€incl. VAT

 **audiophony**
EQUIPEMENTS

An incredible sound.

The 6 loudspeakers 3" and the 1" motor of the column allow a dispersion of 120° horizontally and 30° vertically.

This asymmetrical diffusion avoids reflection phenomena and therefore optimizes rendering even in difficult configurations

Easy to use

Lightweight and robust, subwoofer is made of high-strength wood, plywood Finnish birch with a protective polyurea resin coating that is highly resistant to scratches. You can transport your entire MOJO1200Line system anywhere.

The columns are easy to assemble and disassemble thanks to their stacking system. In addition, to simplify your life, all the amplification is integrated into the MOJO1200Line housing and the connection of the amplification module is clear and precise.

A setup for each configuration

The MOJO1200Line offers the possibility to adjust your sound to your desires. You can choose between 3 factory presets and 5 user presets. They are easy to set up and use.





Feel the power with TWS Bluetooth®.

Discover the “True Wireless Stereo” technology. Send music from your mobile to the MOJO1200Line.

Thanks to the “True Wireless Stereo” technology, it will transmit the Bluetooth audio signal to a second MOJO and you will enjoy the Stereo mode!



Comes with bags!

Protect your MOJO1200Line with Audiophony covers. They are made of high quality nylon and include carrying handles and a zipper system.



Go to dedicated website : mojo1200line.audiophony.com

Column	Subwoofer	Complete system	Amplifier
Power: 180W RMS - 360W max.	Power: 250W RMS - 500W max.	Frequency response: 38 - 18000 Hz	Power: 2 x 600W max
Nominal impedance: 6 Ohms	Nominal impedance: 4 Ohms	SPL max. (@1m): 122 dB	
Boomer: 6x3 inch	Boomer: 1x 10 inch		Input:
Tweeter: 1x1 inch	Dimensions: 366 x 625 x 541 mm		- CH1: 1 x XLR/Line Jack/Mic Combo
Dispersion: 120° x 30° (HxV)	Net weight: 21 kg		- CH2: 1 x XLR/Line Mic/Jack Combo
Connector: Insert in housing			- CH3: 1 x Line jack balanced
Dimensions: 108 x 835 x 98 mm x2			- CH4/5: 1 x RCA L/R line + Bluetooth® input
Net weight: 3.9 kg			
			Output:
			- 1 Insert on the top of the housing for the column
			- 1x XLR MIX OUT balanced for output to another system
			- 2x XLR LINE OUT symmetrical for the CH1 and 2 replicate
			DSP :
			24 bits (1 in 2 out)
			EQ / Presets / low cut / Delay / Bluetooth® TWS
			Level: Level adjustment on each channel + Master

MOJO500LINE

Active subwoofer and column system + mixer with 1 Bluetooth® input

The Almighty featherweight - 500 W

This sound system will amaze you by its presence. We calculated the position of each driver in the column so that everyone around can enjoy your music. Last but not least, the built-in compressor allows a best sound recording from your microphones and better performances. The whole system is easy to transport as it only weighs less than 15 kg!

- + 3-channel mixer with Bluetooth® input
- + Wide-angle column
- + Beautiful vocals and good bass rendering



MOJO500LINE

Active system subwoofer and column + mixer with 1 Bluetooth® input

Code : H10529

529€^{incl. VAT}

 **audiophony**
EQUIPEMENTS



COV-MOJO500LINE

Protective cover for MOJO500LINE & MOJO500liberty

Code : H10867

69€^{incl. VAT}

 **audiophony**
EQUIPEMENTS

 **Bluetooth™**



MOJ0500LIBERTY

500W compact active audio system for all types of applications.

The MOJ0500LIBERTY is an evolution of the already famous MOJ0500LINE.

It retains the same power, the same diffusion technology, the same protections and the same dimensions.

One of the evolutions is found in a brand new ultra-complete mixing desk with reverb, Bluetooth® and all available connector formats. But the major evolution is the contribution of a Panasonic battery allowing an operating autonomy ranging from 5 to 15 hours depending on use.



Very complete 6-channel mixer with 2 microphone inputs, 3 line inputs, 1 Auxiliary and 1 Bluetooth®. Reverb effect adjustable on the microphone and instrument channels.



Battery Lithium PANASONIC®
DC 28.8V / 5800mAh





MOJ0500LIBERTY
Active system subwoofer and column + mixer
+ battery + reverb with 1 Bluetooth® input

Code : H10899 799€^{incl. VAT}



Power rating: 200W max for the column + 300W max for subwoofer
Frequency response: 50Hz -22KHz
SPL max. (@1m) : 116 dB
Woofer: 6 x 2.75" for the column + 1x8" for the subwoofer
Dispersion : 120° x 20° (HxV)
Connectors: 2x Combo Mic/Line + 1x RCA Line et 1x 3.5 Jack Line
Bluetooth® receiver on channel 3
Adjustments: Volume by channel + general Treble/Bass
Dimensions: (80 x 80 x 830 mm) x2 for the column and support 340 x 430 x 400 mm for the subwoofer
Net weight: 3.65 kg + 10.8 kg (12,6 kg for MOJ0500Liberty)

ATOM ACTIVE SPEAKERS



Go to dedicated website :
atom.audiophony.com

The ATOM series is equipped with a simple DSP and is easy to use. It allows you to adjust and configure your speaker to the required use with the touch of a button. The internal processor's different presets adapt your speaker to the current use (front, backstage, etc.) but also the current sound application (DJ, Live, Speech, etc.) without forgetting the ability to correct bass and treble +/- 10dB in order to compensate for a room's acoustic problems, for example.

Each ATOM speaker offers two inputs and one output, a large choice of connectivity in order to connect all kinds of sources at Micro or Line level.



The design of this new series provides usage flexibility and exceptional installation thanks to M10 attachment points, backstage position and an ingenious 35mm double position base allowing the speaker to be used on a stand in a straight or inclined position of 7.5° downwards.







ATOM15A
15-inch active speaker with DSP

Code : H10781 449€^{Incl. VAT}





ATOM12A
12-inch active speaker with DSP

Code : H10780 379€^{Incl. VAT}

ATOM10A
10-inch active speaker with DSP

Code : H10779 369€^{Incl. VAT}



COV-ATOM15A
Protective cover for ATOM15A

Code : H10786 85€^{Incl. VAT}

COV-ATOM12A
Protective cover for ATOM12A

Code : H10785 75€^{Incl. VAT}

COV-ATOM10A
Protective cover for ATOM10A

Code : H10784 69€^{Incl. VAT}



ATOM18ASUB
18-inch active subwoofers with DSP

Code : H10783 849€^{Incl. VAT}



ATOM15ASUB
15-inch active subwoofers with DSP

Code : H10782 749€^{Incl. VAT}



COV-ATOM18ASUB
Protective cover for ATOM18ASUB

Code : H10788 109€^{Incl. VAT}

COV-ATOM15ASUB
Protective cover for ATOM15ASUB

Code : H10787 99€^{Incl. VAT}

	ATOM15A	ATOM12A	ATOM10A
CODE	H10781	H10780	H10779
Total power	400 W RMS - 1600 W DYNAMIC	400 W RMS - 1600 W DYNAMIC	300 W RMS - 1200 W DYNAMIC
Amplification class	D + AB	D + AB	D + AB
Power supply	SMPS switched-mode	SMPS switched-mode	SMPS switched-mode
Protection	Limiter, thermal and short-circuit	Limiter, thermal and short-circuit	Limiter, thermal and short-circuit
Frequency response	45 Hz to 20 kHz	50 Hz to 20 KHz	60 Hz to 20 kHz
Dispersion H x V	90° x 60°	90° x 60°	90° x 60°
SPL pressure	124 dB max	123 dB max	121 dB max
Woofer	15" of 3" coil	12" of 3" coil	10" of 2.5" coil
Tweeter	1.35"	1.35"	1"
Pre-amplification	1 MIC/LINE input on XLR/Jack Combo 1 LINE Input on RCA and 3.5 Jack	1 MIC/LINE input on XLR/Jack Combo 1 LINE Input on RCA and 3.5 Jack	1 MIC/LINE input on XLR/Jack Combo 1 LINE Input on RCA and 3.5 Jack
	Line output on XLR		
	Volume adjustment per channel		
DSP	Equalisation presets: Normal, Live, Club and Speech Position presets: feet, feedback, wall Treble and bass graphic equaliser		
Dimensions (H x W x D)	730 x 425 x 415 mm	628 x 365 x 355 mm	531 x 310 x 300 mm
Net weight	20.6 kg	17.3 kg	11.3 kg

SÉRIE SR

Robustesse, Puissance, Excellence

Resistant, Powerful, Outstanding



2-way passive or active speakers



Outstanding

No matter how hard you push it, the SR series will provide a balanced, dynamic output. These very powerful speakers have an outstanding sound quality, without any distortion even at full power.

Powerful

The incredible SR speakers sound output comes from a D and AB bi-amplification up to 400W RMS, with an outstanding 124 dB SPL.



Resistant

The SR speakers were designed and built for intensive live performances. They are light, robust, and very handy. The 7.5mm HPP housing guarantee an unrivaled solidity.

The SR Series settings meet two specific criteria: simplicity and efficiency. You can access the volume, equalization or operating controls from the dedicated rear panel.





SR ACTIVE SPEAKERS

The SR series speakers have been designed for multi-purpose and intensive use. The four Presets offer effective protection and settings for all kinds of uses whether at the front, backstage, DJ set or Live.





SR15A
Amplified 2-channel speaker - Bass reflex
400 Watts RMS

Code : H10159 429€Incl. VAT

SR12A
Amplified 2-channel speaker - Bass reflex
400 Watts RMS

Code : H10158 359€Incl. VAT

SR10A
Amplified 2-channel speaker - Bass reflex
300 Watts RMS

Code : H10157 299€Incl. VAT





COV-SR15
Cover for SR15A speaker

Code : H10169 69€Incl. VAT

COV-SR12
Cover for SR12A speaker

Code : H10168 65€Incl. VAT

COV-SR10
Cover for SR10A speaker

Code : H10167 59€Incl. VAT



	SR15A	SR12A	SR10A
CODE	H10159	H10158	H10157
Total power	400 W RMS - 800 W MAX	400 W RMS - 800 W MAX	300 W RMS - 600 W MAX
Amplification class	D + AB		
Power supply	SMPS switched-mode		
Protection	Limiter, thermal and short-circuit		
Frequency response	40 Hz to 20 kHz	45 Hz to 20 KHz	55 Hz to 20 kHz
Dispersion H x V	90° x 60°	90° x 60°	90° x 60°
SPL pressure	124 dB max	123 dB max	121 dB max
Woofer	15" of 3" coil	12" of 3" coil	10" of 2.5" coil
Tweeter	1.35"	1.35"	1"
Pre-amplification	1 MIC/LINE input on XLR/Jack Combo Line output on XLR General volume adjustment Flat, Live, DJ and Vocal equalisation presets		
Dimensions (H x W x D)	410 x 450 x 710 mm	360 x 400 x 630 mm	310 x 335 x 530 mm
Net weight	21.1 kg	19.2 kg	13.4 kg

SX ACTIVE SPEAKERS

SX speakers are professional and multi-purpose. The choice of components combined with bi-amplification brings a rich and precise sound. The input connector is linked with an optional Bluetooth module that allows easy use with a smartphone or tablet.



SX15A
300W 15-inch 2-channel active speaker

Code : H10778 329€Incl. VAT



SX12A
300W 12-inch 2-channel active speaker

Code : H10777 299€Incl. VAT



SX-BT
Bluetooth module for SX speaker

Code : H10886 29€Incl. VAT



COV-SX15A
Protective cover for SX15A

Code : H10855 79€Incl. VAT



COV-SX12A
Protective cover for SX12A

Code : H10854 69€Incl. VAT



	SX15A	SX12A
CODE	H10778	H10777
Total power	300 W RMS - 600 W MAX	300 W RMS - 600 W MAX
Amplification class	D	D
Power supply	SMPS switched-mode	SMPS switched-mode
Protection	Limiter, thermal and short-circuit	Limiter, thermal and short-circuit
Frequency response	62 Hz to 19 KHz	65 Hz to 19 KHz
Dispersion H x V	90° x 60°	90° x 60°
SPL pressure	121 dB max	120 dB max
Woofers	15" of 2" coil	12" of 2" coil
Tweeter	1.35"	
Pre-amplification	1 MIC/LINE Input on Combo and RCA Line output on XLR General volume adjustment "Contour" Preset	
Optional module	Bluetooth® receiver 4.0 Pairing, Play/Pause, Skip, Vol buttons	
Dimensions (H x W x D)	630 x 390 x 370 mm	600 x 380 x 340 mm
Net weight	14.5 kg	13.2 kg

PSA ACTIVE SPEAKERS



- Bi-Amping technology with separate amplifiers
- Active two-channel filter
- 2 balanced MIC inputs + 1 LINE input with level adjustment
- Balanced LINE output
- Adjustment buttons for treble + bass + main volume



PSA-15
15" active professional speaker

Code : B00617 289€^{Incl. VAT}



PSA-12
12" active professional speaker

Code : B00616 249€^{Incl. VAT}



PSA-10
10" active professional speaker

Code : B00629 199€^{Incl. VAT}



PSA-08
8" active professional speaker

Code : B00628 169€^{Incl. VAT}



TOURING BAG - PS-15/PSA-15
Cover for PS-15/PSA-15

Code : B00597 49€^{Incl. VAT}



TOURING BAG - PS-12/PSA-12
Cover for PS-12, PSA-12, PPA-121

Code : B00596 39,90€^{Incl. VAT}



	PSA-15	PSA-12	PSA-10	PSA-08
Code	B00617	B00616	B00629	B00628
Total RMS power	245+55 W	165+35 W	130+30 W	120 W
Frequency response	40 Hz to 20 kHz	45 Hz to 20 KHz	60 Hz to 20 KHz	70 Hz to 20 KHz
Dispersion H x V	90° x 60°	90° x 60°	90° x 60°	90° x 60°
Woofer	15"	12"	10 inch	08 inch
Tweeter	1.75"	1.35"	1.35 inch	1 inch
Pre-amplification	1 MIC Input on XLR and RCA 1 LINE Input on RCA and XLR Line Output on XLR and JACK General volume and Mic and Line volume adjustment General Treble and Bass adjustment			
Dimensions (H x W x D)	680 x 470 x 400 mm	588 x 431 x 310 mm	500 x 355 x 270 mm	402 x 294 x 220 mm
Net weight	23.3 kg	17 kg	11.6 kg	8 kg



SC & SQ SERIES

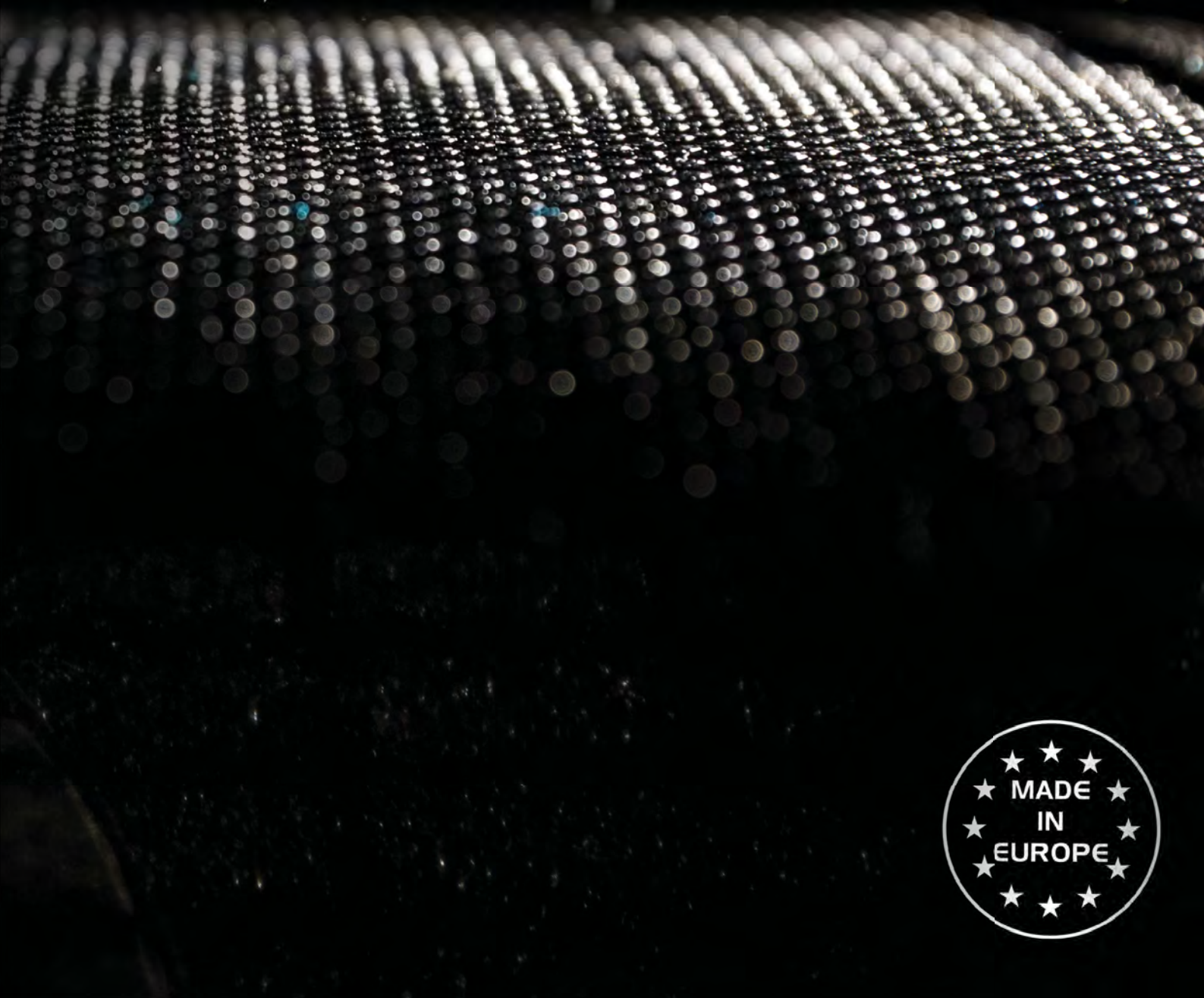

SC PASSIVE SPEAKERS

- Passive speakers for “high-end” performance
- Designed, developed and manufactured in Europe
- European components assembled in Hi-end coaxial speakers
- High quality Baltic birch plywood and polyurethane with coating of “Chemline” (USA) anti-scratch paint
- Very powerful and excellent performance



SC-15
15" 2-channel 400 W AES speaker

Code : B09183 849€^{Incl. VAT}



SC-12
12" 2-channel 400 W AES speaker

Code : B09182 749€^{Incl. VAT}



SC-08
8" 2-channel 300 W AES speaker

Code : B09181 629€^{Incl. VAT}



SC-05
SC-05-WHITE
5" 2-channel 250 W AES speaker

Code : B09180 399€^{Incl. VAT}
Code : B08609 (white)



SC-15	SC-12	SC-08	SC-05
2-channel passive filter	2-channel passive filter	2-channel passive filter	2-channel passive filter
15" low frequency speaker with ferrite + 1.45" tweeter (1" coil)	12" low frequency speaker with ferrite + 1.45" tweeter (1" coil)	8" low frequency speaker with ferrite + 1.45" tweeter (1" coil)	5" low frequency speaker with ferrite + 1.75" tweeter (0.75" coil)
3 Speakons	3 Speakons	Speakon in/out 4-pin	Speakon in/out 4-pin + Euroblock 4-pin connector
Switch selection + -1 or + -2	Switch selection + -1 or + -2	Switch selection + -1 or + -2	Switch selection + -1 or + -2
Enclosure in multi-ply Finnish birch	Enclosure in multi-ply Finnish birch	Enclosure in multi-ply Finnish birch + omega fixing hooks	OMEGA® fastening hook
Resistant textured black paint	Resistant textured black paint	Resistant textured black paint	Can be attached to a microphone stand using the U-bracket
Max SPL: 128dB	Max SPL: 128dB	Max SPL: 123dB	Max SPL: 119dB
Bandwidth: 54-19.000Hz (-3dB)	Bandwidth: 60-20.000Hz (-3dB)	Bandwidth: 70-20.000Hz (-3dB)	Bandwidth: 120-21.000Hz (-3dB)
Polarity: 60° x 40°	Polarity: 60° x 40°	Polarity: 90° cone	Polarity: 70° cone
Power rating: 400 W AES (recommend amplifier: 800W RMS)	Power rating: 400 W AES (recommend amplifier: 800W RMS)	Power rating: 300 W AES (recommend amplifier: 600W RMS)	Power rating: 250 W AES (recommend amplifier: 500W RMS)
Impedance: 8 Ω	Impedance: 8 Ω	Impedance: 8 Ω	Impedance: 16 Ω
Dimension : 368x580x447 mm	Size: 351x540x410 mm	Dimensions: 254x420x250 mm	Size: 165x165x165 mm
Weight: 19 kg	Weight: 16 kg	Weight: 8 kg	Weight: 4 kg

Accessories for attachments and flight cases available, see accessories section



SC & SQ Series

Speakers for "high-end" performance
Designed, developed and manufactured in Europe
High quality Baltic birch plywood and polyurethane with coating of
"Chemline" (USA) anti-scratch paint
Very powerful and excellent performance



VIBE PASSIVE SPEAKERS

- Ideal for fixed installations in bars, clubs
- Very solid MDF enclosure
- Covered with metal grid and with acoustic foam inside
- Fibreglass pavilion



VIBE30 MK2
Pro. speaker : 2x 15" - 800 W RMS / 4 Ω

Code : B00693 489€^{Incl. VAT}



VIBE15 MK2
Pro. speaker : 15" - 350 W RMS / 8 Ω

Code : B00692 329€^{Incl. VAT}



VIBE12MK2
Pro. speaker : 12" - 250 W RMS / 8 Ω

Code : B00691 249€^{Incl. VAT}



VIBE10MK2
Pro. speaker : 8" - 200 W RMS / 8 Ω

Code : B00690 189€^{Incl. VAT}



VIBE8 MK2
Pro. speaker : 8" - 150W RMS

Code : B00689 159€^{Incl. VAT}



CLS-8 II
8" compact high power speaker

Code : B00630 299€^{Incl. VAT}





TOURING BAG
Travel bag for Vibe 30

Code : B00593 82,50€^{Incl. VAT}

TOURING BAG
Travel bag for Vibe 15

Code : B00592 54,90€^{Incl. VAT}

TOURING BAG
Travel bag for Vibe 12

Code : B00591 39€^{Incl. VAT}



VIBE30 MK2	VIBE15 MK2	VIBE12 MK2	VIBE10 MK2	VIBE8 MK2	CLS-8 II
Power rating: 800WRMS	Power rating: 350W RMS	Power rating: 250W RMS	Power rating: 200W RMS	Power rating: 150W RMS	Power rating: 200 WRMS
Impedance: 4 Ω	Impedance: 8 Ω	Impedance: 8 Ω	Impedance: 8 Ω	Impedance: 8 Ω	Impedance: 8 Ω
Max performance (dB) : 131	Max performance (dB) : 125	Max performance (dB) : 122	Max performance (dB) : 120	Max performance (dB) : 120	Max performance (dB) : 125
Bandwidth (Hz) : 40-20000	Bandwidth (Hz) : 45-20000	Bandwidth (Hz) : 55-20000	Bandwidth (Hz) : 65-20000	Bandwidth (Hz) : 65-20000	Bandwidth (Hz) : 70-20,000
Dimensions (cm) : 116 x 49 x 50.3	Dimensions (cm) : 76 x 47 x 43.5	Dimensions (cm) : 62 x 38.2 x 34.5	Dimensions (cm) : 33 x 51 x 30.2	Dimensions (cm) : 46.5 x 27.7 x 27	Dimensions (cm) : 46.0 x 28.6 x 27.6
Weight (kg) : 50	Weight (kg) : 29	Weight (kg) : 20	Weight (kg) : 15	Weight (kg) : 12	Weight (kg) : 13

SR PASSIVE SPEAKERS



SR range: excellence in passive solutions.

The SR series loudspeakers are now available in a passive version. They retain all the manufacturing and reproduction qualities of the series. The passive SR speakers are easy to use and very robust to cope with all your performances.

With a power range from 250 to 350W, the SR speakers deliver a powerful, clear and warm sound, suitable for both voice and live or recorded music.





SR15P
15" 300W plastic moulded passive speaker
- GOA series

Code : H10270 319€^{Incl. VAT}

SR12P
12" 300W plastic moulded passive speaker
- GOA series

Code : H10269 289€^{Incl. VAT}

SR10P
10" 200W plastic moulded passive speaker
- GOA series

Code : H10268 199€^{Incl. VAT}



COV-SR15
Cover for SR15A speaker

Code : H10169 69€^{Incl. VAT}





COV-SR12
Cover for SR12A speaker

Code : H10168 65€^{Incl. VAT}



COV-SR10
Cover for SR10A speaker

Code : H10167 59€^{Incl. VAT}



SR15P	SR12P	SR10P
Output power: 300W RMS / 700W max.	Output power: 300W RMS / 700W max.	Output power: 250W RMS / 400W max.
Frequency response: 45 Hz - 20 KHz	Frequency response: 55 Hz - 20 KHz	Frequency response: 65 Hz - 20 KHz
Impedance: 8 Ω	Impedance: 8 Ω	Impedance: 8 Ω
SPL: 96 dB max.	SPL: 96 dB max.	SPL: 94 dB max.
Dimensions: 410 x 450 x 710 mm	Dimensions: 360 x 400 x 630 mm	Dimensions: 310 x 335 x 530 mm
Net weight: 19.2 Kg	Net weight: 17.8 Kg	Net weight: 11.8 Kg

PS PASSIVE SPEAKERS



PS-15
15" passive 300Wrms/8Ω speaker

Code : B00610 189€^{Incl. VAT}



PS-12
12" passive 200Wrms/8Ω speaker

Code : B00609 149€^{Incl. VAT}



PS-10
10" passive 160Wrms/8Ω speaker

Code : B00627 109€^{Incl. VAT}



PS-08
8" passive 120Wrms/8Ω speaker

Code : B00626 89€^{Incl. VAT}



TOURING BAG - PS-15/PSA-15
Cover for PS-15/PSA-15

Code : B00597 49€^{Incl. VAT}



TOURING BAG - PS-12/PSA-12
Cover for PS-12, PSA-12, PPA-121

Code : B00596 39,90€^{Incl. VAT}



PS-15	PS-12	PS-10	PS-08
Output power: 300W RMS / 600W max.	Output power: 200W RMS / 400W max.	Output power: 160W RMS / 320W max.	Output power: 120 W RMS / 240W max.
Frequency response: 45 Hz - 20 KHz	Frequency response: 45 Hz - 20 KHz	Frequency response: 60 Hz - 20 KHz	Frequency response: 70 Hz - 20 KHz
Impedance: 8 Ω	Impedance: 8 Ω	Impedance: 8 Ω	Impedance: 8 Ω
Dimensions: 680 x 470 x 400 mm	Dimensions: 580 x 420 x 310 mm	Dimensions: 500 x 355 x 270 mm	Dimensions: 402 x 290 x 220 mm
Net weight: 19.8 Kg	Net weight: 13.2 Kg	Net weight: 10.3 Kg	Net weight: 6.6 kg

ILINE PASSIVE SPEAKERS



iLINE83
160W @ 16 Ohms column with 8 3-inch speakers for installation

Code : H10756 249€^{Incl. VAT}



iLINE83w
160W @ 16 Ohms column with 8 3-inch speakers for installation

Code : H10938 259€^{Incl. VAT}



iLINE83sup
iLINE83supw

Wall bracket for iLINE83 column

Code : H10757 (black) 45€^{Incl. VAT}
Code : H10940 (white) 45€^{Incl. VAT}



iLINE43
80W @ 8 Ohms column with 4 3-inch speakers for installation

Code : H10754 149€^{Incl. VAT}



vziLINE43w
80W @ 8 Ohms column with 4 3-inch speakers for installation

Code : H10936 159€^{Incl. VAT}



iLINE43sup
iLINE43supw

Wall bracket for iLINE43 column

Code : H10755 (black) 35€^{Incl. VAT}
Code : H10937 (white) 35€^{Incl. VAT}



iLINE24sup
iLINE24supw

Adjustable wall bracket for iLINE23 and iLINE43

Code : H10773 (black) 69€^{Incl. VAT}
Code : H10945 (white) 69€^{Incl. VAT}



iLINE23
40W @ 16 Ohms column with 2 3-inch speakers for installation

Code : H10752 99€^{Incl. VAT}



iLINE23w
40W @ 16 Ohms column with 2 3-inch speakers for installation

Code : H10934 99€^{Incl. VAT}



iLINE23sup
iLINE23supw

Wall bracket for iLINE23 column

Code : H10753 (black) 29€^{Incl. VAT}
Code : H10935 (white) 29€^{Incl. VAT}



S SERIES PASSIVE SPEAKERS



S6
Passive 6.5P 80W RMS monitor - black

Code : H9689 159€^{Incl. VAT}



S6W
Passive 6.5P 80W RMS monitor - white

Code : H9690 159€^{Incl. VAT}



S8
Passive 8P 150W RMS monitor - black

Code : H9691 269€^{Incl. VAT}



S8W
Passive 8P 150W RMS monitor - white

Code : H9692 269€^{Incl. VAT}



S10
Passive 10P 250W RMS monitor - black

Code : H9693 349€^{Incl. VAT}



S10W
Passive 10P 250W RMS monitor - white

Code : H9694 349€^{Incl. VAT}



ISX-10 (pair)
Compact 2-channel trapezoidal speaker
Price for the pair

Code : B00619 259€^{Incl. VAT}



ISX-5 (pair)
Compact 2-channel trapezoidal speaker
Price for the pair

Code : B00618 209€^{Incl. VAT}



Hanging brackets:

SUPS6	Hanging bracket for S6 satellite - black	H9705
SUPS6w	Hanging bracket for S6 satellite	H9706
SUPS8	Hanging bracket for S8 satellite - black	H9707
SUPS8w	Hanging bracket for S8 satellite - white	H9708
SUPS10	Hanging bracket for S10 satellite - black	H9709
SUPS10w	Hanging bracket for S10 satellite - white	H9710

	S6	S8	S10	ISX-10 (UNIT)	ISX-5 (UNIT)
Power	100W RMS / 200W MAX	150W RMS / 300W MAX	250W RMS / 500W MAX	160 W RMS	80 W RMS
Frequency response	80 HZ / 20 KHZ	80 HZ / 19 KHZ	75 HZ / 19 KHZ	100 Hz - 20 Khz	120 Hz - 20 Khz
Sensitivity	93 DB / 118 DB MAX	94 DB / 121 DB MAX	96 DB / 126 DB MAX	116	110
Impedance	8Ω	8Ω	8Ω	8Ω	16Ω
Speakers	6.5"	8"	10"	2X5"	5 INCH
Dispersion HxV	90° / 60°	50-100° / 55°	50-100° / 55°	-	-
Dimensions	222 x 365 x 205 mm	280 x 420 x 233 mm	320 x 530 x 280 mm	400 X 200 X 180 mm	285 X 200 X 180 mm
Weight	6.5 kg	10 kg	14.5 kg	15.5 kg	10.5 kg

K SERIES PASSIVE SPEAKERS



Tropicalized loudspeaker and aluminum grille for use in humid environments



K-50/Black (pair)
Installation speaker 50 Watts
2-way - 8 Ohms - Black

Code : B00668 89€^{Incl. VAT}



Power rating: 50 W RMS
Available power:
50 W at 8 Ohms
Tweeter: 1 inch
Woofer: 5.25 inch
Frequency response: 55 Hz - 20 kHz
Attachment: swivel bracket
Dimensions: 238 x 180 x 150 mm
Net weight: 5 kg
Price for the pair



K-50/White (pair)
Installation speaker 50 Watts
2-way - 8 Ohms - White

Code : B00669 89€^{Incl. VAT}



Power rating: 50 W RMS
Available power:
50 W at 8 Ohms
Tweeter: 1 inch
Woofer: 5.25 inch
Frequency response: 55 Hz - 20 kHz
Attachment: swivel bracket
Dimensions: 238 x 180 x 150 mm
Net weight: 5 kg
Price for the pair



K-30/Black (pair)
Installation speaker 40 Watts
2-way - 8 Ohms - Black

Code : B00672 55€^{Incl. VAT}



Power rating: 40 W RMS
Available power:
40 W at 8 Ohms
Tweeter: 1 inch
Woofer: 3.5 inch
Frequency response: 65 Hz - 20 kHz
Attachment: swivel bracket
Dimensions: 170 x 130 x 105 mm
Net weight: 2.5 kg
Price for the pair



K-30/White (pair)
Installation speaker 40 Watts
2-way - 8 Ohms - White

Code : B00673 55€^{Incl. VAT}



Power rating: 40 W RMS
Available power:
40 W at 8 Ohms
Tweeter: 1 inch
Woofer: 3.5 inch
Frequency response: 65 Hz - 20 kHz
Attachment: swivel bracket
Dimensions: 170 x 130 x 105 mm
Net weight: 2.5 kg
Price for the pair



K-80/Black (pair)
Installation speaker 85 Watts
2-way - 8 Ohms - Black

Code : B00670 179€^{Incl. VAT}



Power rating: 85 W RMS
Available power:
85 W at 8 Ohms
Tweeter: 1 inch
Woofer: 8 inch
Frequency response: 35 Hz - 20 kHz
Attachment: swivel bracket
Dimensions: 335 x 270 x 210 mm
Net weight: 12.8 kg
Price for the pair



K-80/White (pair)
Installation speaker 85 Watts
2-way - 8 Ohms - White

Code : B00671 179€^{Incl. VAT}



Power rating: 85 W RMS
Available power:
85 W at 8 Ohms
Tweeter: 1 inch
Woofer: 8 inch
Frequency response: 35 Hz - 20 kHz
Attachment: swivel bracket
Dimensions: 335 x 270 x 210 mm
Net weight: 12.8 kg
Price for the pair

SUBWOOFERS



ATOM18ASUB
600 W RMS - 18-inch active subwoofers with DSP

Code : H10783 849€^{Incl. VAT}



ATOM15ASUB
600 W RMS - 15-inch active subwoofers with DSP

Code : H10782 749€^{Incl. VAT}



COV-ATOM18ASUB
Protective cover for ATOM18ASUB

Code : H10788 109€^{Incl. VAT}



COV-ATOM15ASUB
Protective cover for ATOM15ASUB

Code : H10787 99€^{Incl. VAT}



iLINESub12P
12" passive subwoofer - 400W - 8 Ω

Code : H10763 379€^{Incl. VAT}



iLINESub12A
12" active subwoofer 700W + 700W with built-in DSP

Code : H10761 599€^{Incl. VAT}



iLINESub12Pw
12" passive subwoofer - 400W - 8 Ω

Code : H10944 399€^{Incl. VAT}



iLINESub12Aw
12" active subwoofer 700W + 700W with built-in DSP

Code : H10943 649€^{Incl. VAT}



iLINEbox
USB → RJ45 converter for DSP of iLINESub12A

Code : H10762 29€^{Incl. VAT}



iLINEcov
Protective cover for iLINE series subwoofers

Code : H10768 69€^{Incl. VAT}



ATOM-WHEELS
4-wheel kit for ATOMSUB subwoofer

Code : H10875 59€^{Incl. VAT}



SUBWOOFERS



- Passive subwoofers for high-end performance
- Designed, developed and manufactured in Europe
- FAITAL brand components with Neodymium magnet, high quality Baltic birch plywood and coating of polyurethane "Chemline" (USA) anti-scratch paint
- 2400W AES

SQ-218
2x 18" 2400W aes subwoofers

Code : B09189 1 799€^{Incl. VAT}



SQ-215
2x 15" 2400W aes subwoofers

Code : B09188 1 499€^{Incl. VAT}



SQ-212
2x 12" 2400W aes subwoofers

Code : B09187 1 199€^{Incl. VAT}



	SQ-218	SQ-215	SQ-212
CODE	B09189	B09188	B09187
Total power	2400 W AES	2400 W AES	2400 W AES
Impedance	4 Ω	4 Ω	4 Ω
Bass frequency limit	25 Hz	30 Hz	35 Hz
SPL pressure	102 dB 1W/1m - 146 dB max	101 dB 1W/1m - 145 dB max	101 dB 1W/1m - 135 dB max
Woofer	2x18" Faital	2x15" Faital	2x12" Faital
Dimensions (H x W x D)	1180 x 800 x 560 mm	800 x 800 x 540 mm	600 x 600 x 400 mm
Net weight	80 kg	60 kg	38.2 kg

More information on: www.synq-audio.com

SUBWOOFERS

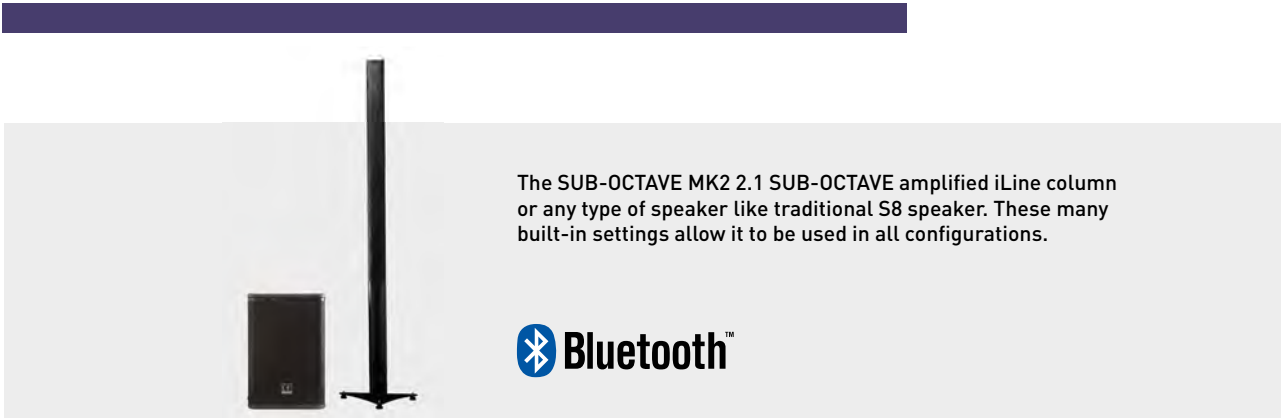

The SUB-OCTAVE MK2 2.1 SUB-OCTAVE amplified iLine column or any type of speaker like traditional S8 speaker. These many built-in settings allow it to be used in all configurations.



Frequency response : 40 – 20 000 Hz
Sensitivity (1 W@1m) : 99 dB
SPL max (1m) : 130 dB
Boomer : 15 inches 100 mm voice coil

AMPLIFIER :
Sub : 1 x 900 W RMS 8 Ohms
Mid/high : 2 x 450 W RMS 4 Ohms
2 x 250 W RMS 8 Ohms
Inputs : 2 x XLR/Jack combo line in
1 x Bluetooth®
Outputs : 2 x XLR line level
2 x Speakon powered Mid/High out
Volumes : Master level

SUB LEVEL :
Sub filter : 40 to 200 Hz X-over with Invert switch
Mid/High filter : Full range / 80 Hz / 120 Hz switch
Equalizer : Low +/- 10dB @ 80 Hz
Mid +/- 10dB @ 2,5 kHz
High +/- 10dB @ 12 kHz
Display : Limit / Signal / ON LEDs
Dimensions : 580 x 405 x 550 mm
Weight : 35 kg

SUB-OCTAVE MK2

Subwoofer 15" 1000W/80ohms +
2x450W/4ohms

Code : H10980

999€^{Incl. VAT}



COV-SUBOCTAVEMKII

Bag for SUBoctave MKII - Noir

Code : H11131

99€^{Incl. VAT}



RS-218B

Subwoofer equipped with two 18" high
power and compact speakers.

Code : B00636

949€^{Incl. VAT}



VIBE18-SUB Mk2

Pro subwoofer: 18" - 600Wrms / 8Ω

Code : B00695

479€^{Incl. VAT}



VIBE15-SUB Mk2

Pro subwoofer: 15" - 400Wrms / 8Ω

Code : B00694

349€^{Incl. VAT}



Nominal RMS power: 2x 600W
Nominal PEAK power: 2x 1200W
Nominal impedance: 2x 8Ω
Parallel mode:
Nominal RMS power: 1x 1200W
Nominal PEAK power: 1x 2400W
Nominal impedance: 1x 4Ω
Frequency response: 35 - 300Hz
Sensitivity (1W/1m): 104dB
Max. SPL: 138dB
Dimensions (WxDxH):
1200 x 700 x 565 mm
Weight (net): 84 kg

Power rating: 600W RMS
Frequency response: 30Hz -250 Hz
SPL max. (1m) : 131 dB
Nominal impedance: 8 Ω
Woofer: 18" aluminium
Connectors: 2 speakon
Dimensions: 590 x 736 x 756 mm
Net weight: 57 kg

Power rating: 400W RMS
Frequency response: 40Hz -300 Hz
SPL max. (1m) : 124 dB
Nominal impedance: 8 Ω
Woofer: 15" aluminium
Connectors: 2 speakon
Dimensions: 440 x 595 x 605 mm
Net weight: 32.5 kg

SUBWOOFERS



TOURING BAG -

Vibe 15 SUB

Travel bag for Vibe 15 SUB

Code : B00594 49,90€^{Incl. VAT}



ISX-15S

Subwoofer 15: 2x350Wrms / 2x 4 ohms

Code : B00620 369€^{Incl. VAT}



I-SUB 210

SYNQ high power subwoofer 2 x 10" with very compact design.

Code : B00642 319€^{Incl. VAT}



TOURING BAG -

Vibe 18 SUB

Travel bag for Vibe 18 SUB

Code : B00595 79€^{Incl. VAT}



High-performance protective cover for Series Vibe models.

Power rating: 500 W RMS
 Frequency response: 50Hz -200Hz
 SPL 1w/1m : 98 dB
 Nominal impedance: 8 Ω
 Woofer: 2x10"
 Connectors: 2 x speakon
 Dimensions: 600 x 350 x 410 mm
 Net weight: 26 kg

High-performance protective cover for Series Vibe models.



SQ-218 DOLLY

Customised SYNQ trolley for fast and safe SQ subwoofer transport

Code : B09192 369€^{Incl. VAT}



SQ-212 DOLLY

Customised SYNQ trolley for fast and safe SQ subwoofer transport

Code : B09190 259€^{Incl. VAT}



SQ-215 DOLLY

Customised SYNQ trolley for fast and safe SQ subwoofer transport

Code : B09191 319€^{Incl. VAT}



WHEELSET

SYNQ set of wheels for subwoofer Synq (RS and CLS series)

Code : B00637 44,90€^{Incl. VAT}



Custom trolley for fast and safe transportation of SQ subwoofers.
 Thanks to a special robust mechanism, the trolley adapts easily to the front of the subwoofer to protect it.

AMPLIFIERS

The heart of playback, performance and durability, exceptional sound quality. Professional and consumer solutions.



DSPA-1500

2 x 440W @ 8Ω, 2 x 750W @ 4Ω,
2 x 1200W @ 2Ω

Code : B00275

539€ Incl. VAT



DSPA-1000

2 x 300W @ 8Ω, 2 x 500W @ 4Ω,
2 x 750W @ 2Ω

Code : B00274

439€ Incl. VAT



SMi1500

Amplifier with switched-mode power
supply 2 x 750W @ 4Ω

Code : H9829

499€ Incl. VAT



SMi600

Amplifier with switched-mode power
supply 2 x 300W @ 4Ω

Code : H9827

309€ Incl. VAT



DSPA-1500



SMi1500

	DSPA-1500	DSPA-1000	SMi1500	SMi600
Power	<ul style="list-style-type: none"> - RMS stereo 4Ω: 2 x 750W 4Ω: 2 x 440W 2Ω: 2 x 1200W <ul style="list-style-type: none"> - Bridged mono 8Ω: 1 x 1500W 4Ω: 1 x 2400W 	<ul style="list-style-type: none"> - RMS stereo 4Ω: 2 x 500W 8Ω: 2 x 300W 2Ω: 2 x 750W <ul style="list-style-type: none"> - Bridged mono 8Ω: 1 x 1000W 4Ω: 1 x 1500W 	<ul style="list-style-type: none"> - RMS stereo 4Ω: 2 x 750W 8Ω: 2 x 450W 2Ω: 2 x 1000W <ul style="list-style-type: none"> - Bridged mono 8Ω: 1 x 1500W 4Ω: 1 x 2000W 	<ul style="list-style-type: none"> - RMS stereo 4Ω: 2 x 300W 8Ω: 2 x 200W 2Ω: 2 x 450W <ul style="list-style-type: none"> - Bridged mono 8Ω: 1 x 600W 4Ω: 1 x 900W
Type of amplification	Class D	Class D	Class 2H	Class AB
Damping factor	200	200	200	100
Cooling	Front-to-back regulated ventilation			
Connectors	<ul style="list-style-type: none"> - Input: Balanced combo (XLR + TRS jack) connector - Output: Screw-on terminals + 4-pole Speakon® 		<ul style="list-style-type: none"> - Input: XLR + Jack + RCA connectors - Output: Screw-on terminals + 4-pole Speakon® 	
Protections	<ul style="list-style-type: none"> - Against short-circuits - Signal and current limiter - Against voltage deviations - Thermal protection 		<ul style="list-style-type: none"> - Against short-circuits - Current limiter - Against voltage deviations - Immunity to radio frequencies - Thermal protection and regulation 	
DSP	HPF, LPF, PEQ, Q, Limiter, Delays, filters.			
Dimensions (L x W x H)	19" x 2U (482 x 88 x 280mm)		19" x 2U: 483 x 89 x 395mm	
Weight	5.2kg	4.9 kg	9.2 kg	6 kg

AMPLIFIERS



DIGIT 3K6

2 x 1,800Wrms / 4Ω, class D

Code : B00267

709€^{Incl. VAT}



DIGIT 2K2

2 x 1,100Wrms / 4Ω, class D

Code : B00266

629€^{Incl. VAT}



DIGIT 1K0

2 x 540Wrms / 4Ω, class D

Code : B00268

319€^{Incl. VAT}



DIGIT 1K0

	DIGIT 3K6	DIGIT 2K2	DIGIT 1K0
Power	<ul style="list-style-type: none"> - RMS stereo 4Ω : 2 x 1800 W 8 Ω : 2 x 1050 W - Bridged mono 8 Ω : 1 x 3600W 	<ul style="list-style-type: none"> - RMS stereo 4Ω : 2 x 1100 W 8 Ω : 2 x 650 W - Bridged mono 8 Ω : 1 x 2200W 	<ul style="list-style-type: none"> - RMS stereo 4Ω : 2 x 540 W 8 Ω : 2 x 300 W - Bridged mono 8 Ω : 1 x 1080W
Type of amplification	Class D	Class D	Class D
Damping factor	300	300	280
Cooling	Front-to-back regulated ventilation		
Connectors	Input + Output : XLR		
Protections	<ul style="list-style-type: none"> - Against short-circuits - Signal + current limiter - Against overloads - Thermal protection - AC, VHF protection 		
Dimensions (L x W x H)	19" x 1 U: 483 x 44 x 301 mm		19" x 1 U: 483 x 44 x 301 mm
Weight	5.6 kg	5.5 kg	3.3 kg

AMPLIFIERS



The perfect music of silence

When silence is a very important factor, you can rely on the Ti series which works as silently as possible.

That makes them perfect for studio, permanent installations and theatres.

These Class D amplifiers feature SMPS units and offer a perfect sound reproduction despite their ultra-compact size.

With every connection you need, they're perfectly adapted for any sound system, studio, and even HiFi applications.

They also feature thermal and electronic protections, so you can operate them safely and with great serenity.

<p>Ti500 Class D Amplifier 1 unit 2 x 250W @ 4Ω or 1 x 500W @ 8Ω</p>	<p>Ti300 Class D Amplifier 1 unit 2 x 150W @ 4Ω or 1 x 300W @ 8Ω</p>	<p>Ti154 Class D Amplifier 1 unit 4 x 150W @ 4Ω or 2 x 300W @ 8Ω</p>
Code : H9673 289€ ^{Incl. VAT}	Code : H9672 229€ ^{Incl. VAT}	Code : H10412 379€ ^{Incl. VAT}

	Ti500	Ti300	Ti154
Power	<ul style="list-style-type: none"> - RMS stereo 4Ω : 2 x 250 W 8 Ω : 2 x 130 W - Bridged mono 8 Ω : 1 x 500W 	<ul style="list-style-type: none"> - RMS stereo 4Ω : 2 x 150 W 8 Ω : 2 x 80 W - Bridged mono 8 Ω : 1 x 300W 	<ul style="list-style-type: none"> 4Ω : 4 x 150 W RMS 8 Ω : 4 x 80 W RMS
Type of amplification	Class D		
Cooling	Silent cooling - Non-ventilated		
Connectors	<ul style="list-style-type: none"> - Input: XLR/Jack combo connectors - Output: 4-pole Speakon® + terminal blocks 		
Protections	<ul style="list-style-type: none"> - Against short-circuits - Signal + current limiter - Against overloads - Thermal protection 		
Dimensions (L x W x H)	19 inches x 1U: 483 x 44 x 330 mm	19 inches x 1U: 483 x 44 x 330 mm	19 inches x 1U: 483 x 44 x 330 mm
Weight	4.7 kg	4.3 kg	4.5 kg



Ti-154

AMPLIFIERS



PE-2400

2 x 1,200Wrms / 4Ω, class H

Code : B00265

749€^{Incl. VAT}



PE-900

2 x 450Wrms / 4Ω, class H

Code : B00263

499€^{Incl. VAT}



PE-2400



WA-4X3

4 channel amplifier 4 x 300W RMS @ 4Ω

Code : H9066

699€^{Incl. VAT}



WA-4X3

	PE-2400	PE-900	WA-4X3
Power	<ul style="list-style-type: none"> - RMS stereo 4Ω : 2 x 1200 W 8 Ω : 2 x 800 W 2 Ω : 2 x 1440 W <ul style="list-style-type: none"> - Bridged mono 8 Ω : 1 x 2,400W 4Ω : 1 x 2800 W 	<ul style="list-style-type: none"> - RMS stereo 4Ω : 2 x 450 W 8 Ω : 2 x 300 W 2 Ω : 2 x 540 W <ul style="list-style-type: none"> - Bridged mono 8 Ω : 1 x 900 W 4Ω : 1 x 1080 W 	<ul style="list-style-type: none"> - RMS stereo 4Ω : 4 x 300 W 8 Ω : 4 x 200 W <ul style="list-style-type: none"> - Bridged stereo 8 Ω : 2 x 600 W - 2.1 stereo 8 Ω : 2 x 200 W + 1 x 600W bridged
Type of amplification	Class H	Class H	Class AB
Damping factor	450	450	200
Cooling	Front-to-back regulated ventilation		
Connectors	<ul style="list-style-type: none"> - Input: XLR/Jack combo connectors - Output: 4-Pole Speakon® 		<ul style="list-style-type: none"> - Input: XLR + jack + RCA connectors - Output: Screw-on terminals + 4-pole Speakon®
Protections	<ul style="list-style-type: none"> - Against short-circuits and overloads - Automatic current limiter - Against DC current - High-temperature protection 		<ul style="list-style-type: none"> - Against short-circuits - Current limiter - Against voltage deviations - Immunity to radio frequencies - Thermal protection and regulation
Dimensions (L x W x H)	19" x 2 U: 483 x 89 x 440 mm		19" x 2 U: 483 x 89 x 375 mm
Weight	25 kg	16,8 kg	16 kg

AMPLIFIERS



VX700 II
Professional amplifier 2 x 350Wrms / 4Ω.

Code : B00295 314,90€^{Incl. VAT}



VX400 II
Professional amplifier 2 x 200Wrms / 4Ω.

Code : B00294 229€^{Incl. VAT}



VX200 II
Professional amplifier 2 x 110Wrms / 4Ω.

Code : B00293 219€^{Incl. VAT}



VX700 II

	VX700 II	VX400 II	VX200 II
Power	- RMS stereo 4Ω: 2 x 350 W 8 Ω : 2 x 200 W - Bridged mono 8 Ω : 1 x 700 W	- RMS stereo 4Ω: 2 x 200 W 8 Ω : 2 x 135 W	- RMS stereo 4Ω: 2 x 110 W 8 Ω : 2 x 65 W - Bridged mono 8 Ω : 1 x 220 W
Type of amplification	Class D	Class D	Class D
Damping factor	200	150	150
Cooling	Front-to-back regulated ventilation		
Connectors	- Input: XLR + jack connectors - Output: Screw-on terminals + 4-pole Speakon®		
Protections	- Against short-circuits - Current limiter - Thermal protection and regulation		
Dimensions (L x W x H)	19" x 2 U: 483 x 89 x 260 mm		19" x 1U 483 x 44 x 320 mm
Weight	13 kg	9 kg	9.5 kg

AMPLIFIERS



AVM-3
Class D amplifier module for VIBE18-SUB Mk2.

Code : B00242 329€^{Incl. VAT}



AVM-2
Class D amplifier module for VIBE15 Mk2, VIBE30 Mk2 and VIBE15-SUB Mk2.

Code : B00241 319€^{Incl. VAT}



AVM-1
Class D amplifier module for VIBE8 Mk2, VIBE10 Mk2 & VIBE12 Mk2

Code : B00240 219€^{Incl. VAT}



	AVM-3	AVM-2	AVM-1
Power	4Ω: 1200W RMS 8 Ω : 800 W RMS	4Ω: 800 W RMS 8 Ω : 500 W RMS	4Ω: 500 W RMS 8 Ω : 300 W RMS
Type of amplification	Class D		
Damping factor	350	350	320
Cooling	Regulated ventilation		
Connectors	- Input: XLR+jack+RCA connectors - Output: Speakon® 1+/1-		
Protections	- Against short-circuits - Signal + current limiter - Against overloads - Thermal protection		
Dimensions (L x W x H)	320 x 160 x 87 mm	320 x 160 x 87 mm	275 x 145 x 72 mm
Weight	2,79 kg	2,79 kg	2,39 kg

More information on: www.jb-systems.eu

SOUND PROCESSING

**DANTE™ is the NEW STANDARD for “Audio over IP” !
Just call it “Art-Net for audio” !**

DANTE™ advantages:

- Uncompressed multi-channel audio over standard Ethernet networks.
- No bulky snake cables !
- No more buzzing due to ground loops !
- Cheap CAT5E-cabling + standard Ethernet switches
- Plug & Play : auto discovery, no IP-addresses, no network knowledge required!
- Easy routing of audio signals ! (Free Dante™ Controller software)
- Extremely low latency: < 1 ms
- Virtual Sound Card: turns any Windows PC / MAC into a Dante™ audio device.
- Up to 512 audio channels per GIGABIT network!
- Automatic discovery of all Dante™ devices on the network
- 1 Universal protocol: no compatibility problems !

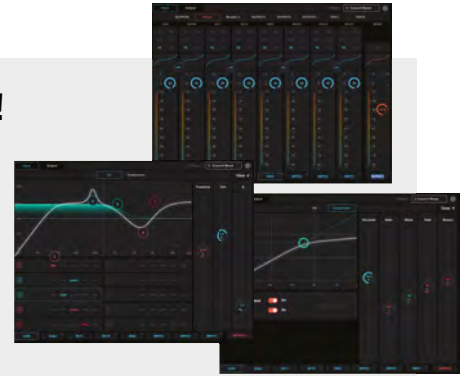

DBI-04
Dante/analog audio bridge, 4out, INSTALL

Code : B08203 939€^{incl. VAT}



EUROBLOCK connector with 4 outputs
GPI & GPO for extra functionality and control:
4 General Purpose Inputs: can be used to connect an on/off switch, potentiometer (adjustable voltage), ...
4 General Purpose Outputs: can be used to control other equipment (switch equipment or lamps on/off, trigger a Powerpoint presentation, ...)
Power: +24Vdc, PoE (Power over Ethernet)
Port 1+2 activity indication on front
AUDIO DSP with webpage control for extra functionality: compressors, limiters, parametric EQ, ...
8x8 MATRIX: local premix, routing, ...
Optional half 19" mounting bracket: 2 units in 1U 19" rack



DBI-44
Dante/analog audio bridge, 4in/4out, INSTALL

Code : B08204 1089€^{incl. VAT}



EUROBLOCK connector with 4 inputs
EUROBLOCK connector with 4 outputs
GPI & GPO for extra functionality and control:
4 General Purpose Inputs: can be used to connect an on/off switch, potentiometer (adjustable voltage), ...
Possibility to connect a potentiometer to adjust the volume of one or more inputs and/or outputs
4 General Purpose Outputs: can be used to control other equipment (switch equipment or lamps on/off, trigger a Powerpoint presentation, ...)
Power supply: +24VDC, PoE (Power over Ethernet)
Port 1+2 activity indication on front
AUDIO DSP with webpage control for extra functionality: compressors, limiters, parametric EQ, ...
8x8 MATRIX: local premix, routing, ...
Optional half 19" mounting bracket: 2 units in 1U 19" rack



DBT-04
Dante/analog audio bridge, 4out, TOURING

Code : B08205 1089€^{incl. VAT}



4 Balanced male XLR-outputs
2 RJ45 Gigabit Ethernet I/O ports with internal switch.
Power: 100-240Vac PowerCON, PoE (Power over Ethernet)
Audio DSP with webpage control for extra functionality:
compressors, limiters, parametric EQ, ...
8x8 MATRIX: local premix, routing, ...
Optional half 19" mounting bracket: 2 units in 1U 19" rack
Rubber corners: for use as stage box



DBT-44
Dante/analog audio bridge, 4in/4out, TOURING

Code : B08206 1249€^{incl. VAT}



4 Balanced Combo-inputs
LINE + MIC (-24dB PAD & 48V Phantom)
4 Balanced male XLR-outputs
2 RJ45 Gigabit Ethernet I/O ports with internal switch.
Power: 100-240Vac PowerCON, PoE (Power over Ethernet)
Audio DSP with webpage control for extra functionality:
compressors, limiters, parametric EQ, ...
8x8 MATRIX: local premix, routing, ...
Optional half 19" mounting bracket: 2 units in 1U 19" rack
Rubber corners: for use as stage box

DANTE™ requirements:

Currently not all audio equipment can talk Dante™ language. The new Synq Dante™ I/O interfaces translate analog audio to and from Network Audio (Dante™).

Analog → Dante™:

- Connect your MIC to the Dante™ network
- Connect your Guitar, audio player, etc. to the Dante™ network

Dante™ → Analog:

- Connect the Dante™ network to your analog amplifier/active speaker
- Connect the Dante™ network to Recorder with analog input

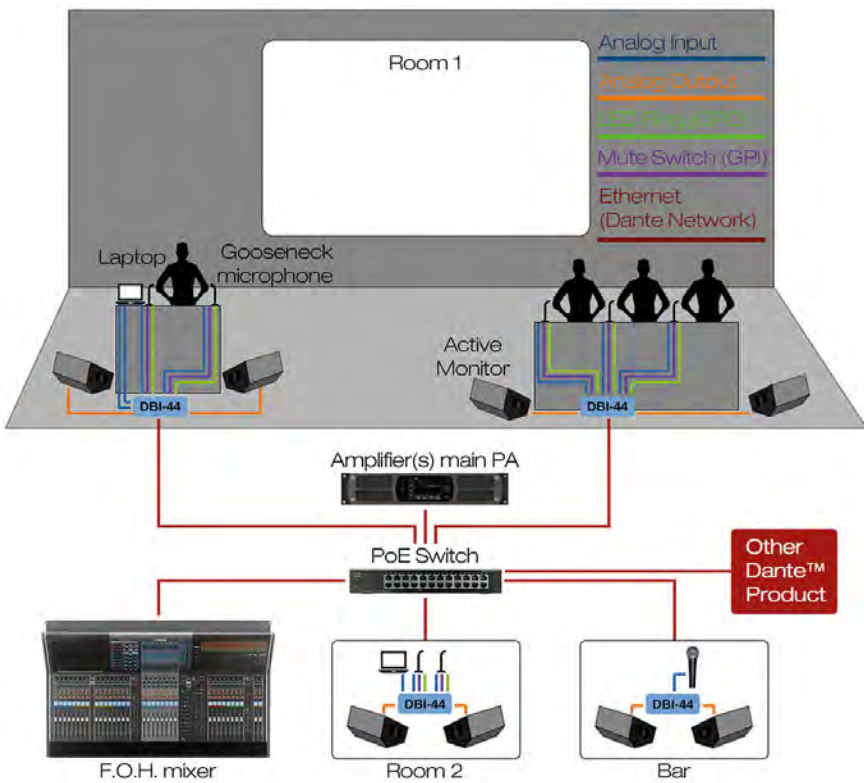

Multi-room install example using PoE

Room 1:

- Easy cabling :
1 single Cat5e network cable transports all audio signals in both directions. This makes it very easy to expand and modify the existing system.
- A single GPI trigger (here a potentiometer on the desk which is plugged into the DBI-44) sends a signal to the GPO connected devices (the gooseneck microphones and a LED light) to turn them on and off. GPIO can also be used to trigger or communicate with anything else on the network.
- Record and play audio from and to any room on the Dante™ network.

Room 2:

- No need for a separate mixer:
Mix all sources (2 microphones, one audio input from a computer, the audio from the main room) using the DBI-44 its integrated web browser and add EQ, compression, etc.
- If you need extra audio inputs just add an extra DBI-44 box. Thanks to the DBI-44 its integrated 8x8 matrix you can easily mix up to 8 separate inputs.
- GPIO allows you to control the gain of each microphone locally. Just connect a potentiometer to one of the GPI inputs.

Bar:

- The DBI-44 box allows the playback of background music originating from any sound source in the Dante™ network.
- The DBI-44 box also allows to connect an extra microphone for announcements

BUILT IN MATRIX AND AUDIO TREATMENT

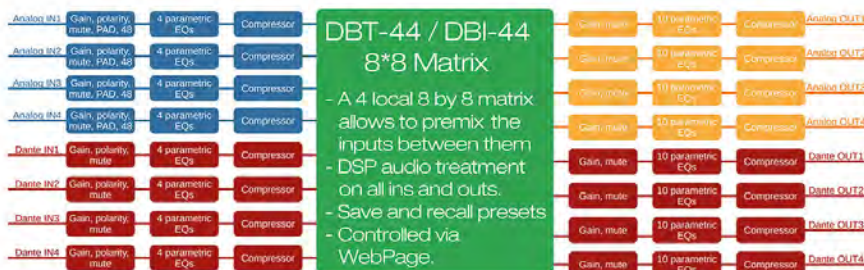

SOUND PROCESSING

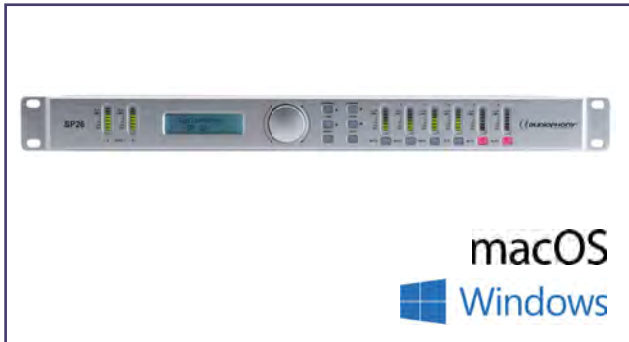

SP26

2IN6OUT sound processor with software

Code : H10712

499€^{Incl. VAT}



Inputs: 2 balanced inputs
 Outputs: 6 balanced outputs
 Sampling rate: 96kHz, 24-bit depth
 Crossover / EQ Operational frequency range: 20Hz – 20kHz
 Crossover filtering: Bessel, Butterworth (6, 12, 24 and 48dB/octave), Linkwitz-Riley (12 and 24dB/octave)
 10-band equaliser: Bell, Notch, All Pass, Band Pass, Low/High Pass, Low/High Shelf
 Equaliser gain : adjustable from -12dB to +12dB
 Equaliser Q: Adjustable from 0.2 to 25
 Phase inversion
 Limiter attack time from 10 to 100
 Limiter threshold from -48dB to 9dB
 Password protection
 50 presets available
 Dimensions (mm): 483 x 127 x 45 (1U)
 Weight: 3kg



Q215

2x15-band equaliser +/- 12dB - 1U

Code : H9670

139€^{Incl. VAT}



Stereo equaliser, 2/3 octaves from 31.5Hz to 16kHz
 Adjustable output level: +12/-12 dB
 20mm faders
 Low-cut filter per channel (60Hz -3dB)
 Balanced inputs: XLR, 6.35 TRS jack
 Unbalanced inputs: RCA
 Balanced outputs: XLR, 6.35 TRS jack
 Unbalanced outputs: RCA
 Recording output (REC OUT) on unbalanced RCA (output level -6 dB)
 Signal level indicator: -10dB, 0dB, +10dB, +17dB
 Low-cut and bypass indicator
 Dimensions: 483 x 44 x 190 mm
 Weight: 2.4kg



BEQ-15

2x15-band stereo equaliser.

Code : B00288

125€^{Incl. VAT}



2 x 15-band stereo equaliser 2/3 octaves from 25Hz to 16kHz
 Adjustable output level: +/-6dB or +/- 12dB
 20mm faders
 Balanced inputs: XLR, 6.35 TRS jack
 Unbalanced inputs: RCA
 Balanced outputs: XLR, 6.35 TRS jack
 Unbalanced outputs: RCA
 Level switch: 6dB/12dB
 Equaliser bypass switch
 Subsonic filter switch
 < 20Hz
 Dimensions: 483 x 44 x 165 mm
 Weight: 2.5 Kg

SP26

- + Windows user interface software for unit configuration
- + Real-time monitoring
- + Sounding performance of any small or mid sized application

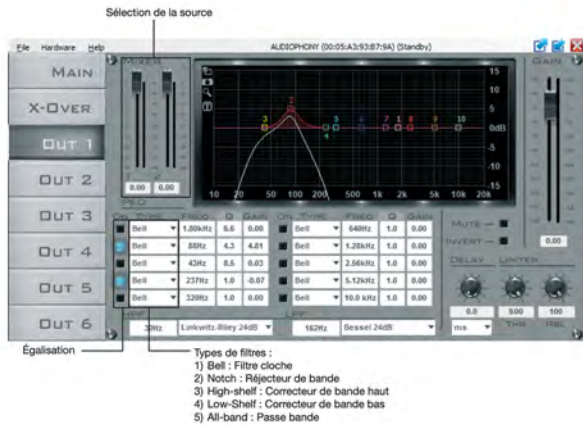

3. Interface X-OVER



ConvD2in

Converter Dante RJ45 - Analog in XLR3

Code : H11050

169€^{Incl. VAT}



2 x XLR female
 1 x RJ45
 Input impedance: 20KΩ (balanced) / 10KΩ (unbalanced)
 Frequency response: 20Hz - 20kHz±0.5 dBu
 Sampling rate: 24 bit 44.1 kHz/48 kHz
 Power supply: POE (Power over Ethernet)
 Consumption: <-2W



ConvD2out

Dante RJ45 - Analog Out XLR3 converter

Code : H11049

179€^{Incl. VAT}



2 x XLR male
 1 x RJ45
 Impedance: 150Ω (balanced) / 75Ω (unbalanced)
 Frequency response: 20Hz - 20kHz±0.5 dBu
 Sampling rate: 24 bit 44.1 kHz/48 kHz
 Power supply: POE (Power over Ethernet)
 Consumption: <-2W

SOUND PROCESSING



X312

2-way stereo or 3-way mono active filter

Code : H9669 139€^{incl. VAT}



Inputs / outputs on balanced XLR + 4dB Stereo (2-way + subwoofer) or mono (3-way + subwoofer) operation
LOW SUM mode to sum low frequencies from both inputs and output to mono
Lows, mids and highs phase reversal possible
In stereo mode:
- Adjustment of cut-off frequency between highs and lows for each side (45 to 960Hz)
In mono mode:
- Adjustment of cut-off frequency between highs, mids and lows (45 to 960Hz and 450 to 9,600Hz)
- Optional use of SUB output with adjustable level and cut-off frequency (20 to 200Hz)
Dimensions: 483 x 175 x 44mm
Weight: 2kg



XO 2.4

Active filter: 2-way stereo or 3-way mono.

Code : B00287 109€^{incl. VAT}



Balanced XLR inputs and outputs
Stereo or mono operation
Phase reversal switch
40Hz subsonic filter (with on/off switch)
In stereo mode:
- Adjustment of cut-off frequency between highs and lows for each side (45 to 960Hz)
In mono mode:
- Adjustment of cut-off frequency between highs, mids and lows (45 to 960Hz and 450 to 9,600Hz)
Dimensions: 483 x 136 x 44mm
Weight: 2kg



ENH 2.3

Professional multi-band sound enhancer

Code : B00286 119€^{incl. VAT}



Adds harmonics to sound, increasing definition, presence and transparency. Considerably enhances low frequencies (more punch)
Balanced XLR inputs and outputs
Separate subwoofer output with adjustable output level and cut-off frequency from 100 to 250Hz.
Low Mix adjustment for lows HPF from 1 to 8kHz for cut-off frequency
High Mix adjustment for high-mids
Phase reversal switch
CLIP indicator
Level indicator -40/-20/-6/-2dB
Dimensions: 483 x 154 x 44mm
Weight: 1 kg



SDI-1

Stereo DI-box. Converts unbalanced audio signals into balanced signals

Code : B00279 59€^{incl. VAT}



This stereo DI-box is the perfect solution for various applications!
It allows conversion of unbalanced audio signals into balanced signals for transport through long cables.
The "ground lift" switch allows separation of the inputs/outputs to avoid ground loops.
Solid anodised aluminium black housing
1 RCA and XLR/6.35 jack combo input
1 XLR output
Max. input level: +21dBu
Dimensions: 105 x 110 x 44 mm
Weight: 0.440 Kg



BDA-100

Active direct box

Code : H7678 55€^{incl. VAT}



1 unbalanced 6.35 jack input
1 balanced XLR input
1 XLR output
Max. input level: 0/+20/+40dB
Dimensions: 135 x 55 x 130 mm
Weight: 0.700 Kg
9V battery not included



CONVERTER

USB/LINE converter and PHONO with Soft

Code : H9077 39€^{incl. VAT}



Provided with Audacity, the French audio processing software
Comprehensive and efficient tools to optimise the quality of your recording
Simple user interface, allowing to record vinyl records at high speed.
Plug-and-play and driverless operation with most audio software on the market.
2 RCA inputs (L and R), line/phono switch
- 2 RCA outputs (L and R), line level
Cable length: 1.5m



BT10ER2

Bluetooth® 4.2 transmitter-receiver

Code : H10981 59€^{incl. VAT}



Bluetooth® 4.2
Supported Bluetooth® Profiles: A2DP and AVRCP
Apt-x® CSR™ Low Latency decoder for HD audio quality and low latency
Operating distance: 10 meters on average - Class 2
Autonomy up to 20 hours on average
Battery: Lithium polymer 270mAh rechargeable battery
Optical digital SPDIF and 3.5» jack digital optical connector
Volume control with touch-sensitive keys



BT-20R

Bluetooth® receiver HD
3.5 jack output + USB charger

Code : H10305 39€^{incl. VAT}



Bluetooth® 4.2
Supported Bluetooth® profiles: apt-X, A2DP and AVRCP
Apt-x® decoder Low Latency 32ms
Operating distance: 10 metres on average - Class 2
Power supply: AC100-240V 50/60Hz
USB output current: 5V / 1A / 5W
3.5mm jack and RCA cable included

MIXERS



- 1/2/4 microphone inputs via XLR plugs
- 1/2/4 Jack 6.35 balanced line input.
- 1/2 unbalanced stereo inputs on RCA and 3.5 jack
- 2-band equalizer on mic/line and stereo channels
- Gain control for each channel
- AUX level setting on each channel (Mi4U et Mi6U)
- Balanced MAIN output on 6.35 Jack
- Unbalanced Record output via RCA plugs
- Balanced AUX output on 6.35 Jack (Mi4U et Mi6U)
- Monitoring output via stereo Jack 6.35
- 1 USB port for connecting a computer (Mi4U et Mi6U)
- LED vu-meter for MAIN output



Mi3

Mix 3 channels 2 Mic and 1 stereo

Code : H10909

74,90€^{Incl. VAT}

audiophony
EQUIPEMENTS



Mi4U

Mixer 4 channels 2 Mic + 2 stereo and 1 Aux + USB port

Code : H10910

109€^{Incl. VAT}

audiophony
EQUIPEMENTS



Mi6U

Mixer 6 channels 4 Mic + 2 stereo and 1 Aux + USB port

Code : H10911

134,90€^{Incl. VAT}

audiophony
EQUIPEMENTS

MIXERS



NEW



Mi46U-STAND
Microphone stand adapter for Mi4U, Mi6U and MIXtouch8 mix

Code : H10987 24€ incl. VAT

audiophony
EQUIPMENTS



Mi46U-STAND

Microphone stand adapter for Mi4U, Mi6U and MIXtouch8 mix

	Mi3	Mi4U	Mi6U
Mic Input	2	2	4
Stereo Input	1	2	2
Aux	-	1	1
Stereo L/R Output	1	2	2
USB port full duplex	-	1	1
Phantom power	+48V DC		
Gain	65dB(MIC main output)		
MIC CH. EQ±15dB	HI: 12kHz, LO:80Hz		
LINE CH. EQ±15dB	HI: 12kHz, LO:80Hz		
Frequency response	[20-20kHz]±1dB		
Maximum Output Level	+20dBu		
Meter	4 segments [-20dB to CLIP]		
Distortion	≲ 0.08% (20-20kHz)		
Power supply	DC 12V external adaptor		
Weight (kg)	0.54	0.78	0.98
Dimension[W*D*H]mm	190x140x68	220x160x68	220x220x68

MIXERS



Mixing consoles for live mixing with 16 effects DSP plus compressors on microphone channels.

The integrated USB/SD/BT device avoids the need for additional peripherals for background music.



MPX16



Bluetooth™

MPX6
Mixer 6 CH + compressor + Effects + USB/SD/BT player

Code : H10905 219€^{Incl. VAT}

audiophony
EQUIPMENTS



Bluetooth™

MPX8
Mixer 8 CH + compressor + Effects + USB/SD/BT player

Code : H10906 259€^{Incl. VAT}

audiophony
EQUIPMENTS



Bluetooth™

MPX12
12CH Mixer + Compressor + Effects + USB/SD/BT Player

Code : H10907 359€^{Incl. VAT}

audiophony
EQUIPMENTS



Bluetooth™

MPX16
16CH Mixer + Compressor + Effects + USB/SD/BT Player

Code : H10908 489€^{Incl. VAT}

audiophony
EQUIPMENTS



Rack brackets for
MPX mixers
(the pair)



NEW

MPX12-RACK
Racking brackets for MPX12

Code : H10986 55€^{Incl. VAT}

NEW

MPX8-RACK
Rack brackets for MPX8

Code : H10985 44€^{Incl. VAT}

NEW

MPX6-RACK
Rack brackets for MPX6

Code : H10984 42€^{Incl. VAT}

	MPX6	MPX8	MPX12	MPX16
Inputs	6	8	12	16
Mic Input channels	2	4	8	12
Stereo Input channels	2	2	2	2
Gain	MIN - MAX	MIN - MAX	MIN - MAX	MIN - MAX
Mic	+6dB - +50dB	+6dB - +50dB	+6dB - +50dB	+6dB - +50dB
Line	+10dB - -34dB	+10dB - -34dB	+10dB - -34dB	+10dB - -34dB
EIN	-100dB	-100dB	-100dB	-100dB
Frequency response	-	-	-	-
Mic Channel	10Hz - 20kHz +1/-3	10Hz - 20kHz +1/-3	10Hz - 20kHz +1/-3	10Hz - 20kHz +1/-3
THD Mic Channel	≤0.03%	≤0.03%	≤0.03%	≤0.03%
Signal to noise ratio	80dB	80dB	80dB	80dB
Output Levels	MAX +27(BAL)	MAX +27(BAL)	MAX +27(BAL)	MAX +27(BAL)
	MAX +22(UNBAL)	MAX +22(UNBAL)	MAX +22(UNBAL)	MAX +22(UNBAL)
Hi	2.5kHz	2.5kHz	2.5kHz	2.5kHz
Mid	2.5kHz	2.5kHz	2.5kHz	2.5kHz
Low	45Hz	45Hz	45Hz	45Hz
Low Cut	80Hz	80Hz	80Hz	80Hz
Compressor	YES	YES	YES	YES
+ 48V Phantom power	YES	YES	YES	YES
MP3/USB/SD Media Player	YES	YES	YES	YES
DSP Effects 16 programs	YES	YES	YES	YES
Bluetooth player	YES	YES	YES	YES
Dimensions (W x H x D)	227x70x359[mm]	283x70x359[mm]	395x70x359[mm]	395x70x359[mm]

MIXERS



LIVEtouch20

LIVEtouch20 - 20 channel digital mixing console

Code : H10901 759€^{Incl. VAT}



LIVEtouch-RACK

Rack for LIVEtouch20

Code : H10959 29,90€^{Incl. VAT}



CASE FOR LIVEtouch20

Flight case for LiveTouch20 mixer

Code : B03292 199€^{Incl. VAT}



FEATURES

- 12 microphone inputs + 2 stereo inputs
- 1 S/PDIF input/output and 1 AES/EBU output
- 4 mono busses / 5 stereo busses / 1 monitor bus
- 8 assignable XLR outputs
- 1 stereo monitor output and 1 headphone output
- 1 x 7" touch screen
- 8 effect modules
- 2 USB plugs for song recording, song playback and scene backups

TECHNICAL DATA

- Inputs : 12 microphones (4 Combo), 2 stereo, S/PDIF and USB
- Input channel functions : Phase, Delay, high pass filter, 4 band parametric equalizer, noise gate, compressor, pan, effects
- Outputs : 8 assignable XLR, AES/EBU, S/PDIF and headphone
- Internal signal generator : White, sinusoidal and white noise

- Phantom power : 48V independently activatable on each channel
- USB Features : Play and record songs, system update, scene backup and external network card
- Screen : 7-inch, 1024 x 600 pixel, high definition touchscreen
- AD/DA : 192 KHz/24 bits max.
- Sampling frequency : 48 KHz / 44.1 KHz
- DSP : SHARC ADI 40-bit floating point processor, 4th generation, 450M
- Effects : 8 modules: 2 Reverbs, 2 Modulation, 2 Delay and 2 x15 bands graphic equalizers
- Système : Custom Android
- Network : Via 1 external USB module (supplied)
- Remote control : Via 1 iPad application
- Power supply : 100-240V 50/60Hz → DC12V
- Size : 445 x 325 x 100 mm
- Weight : 5.3 Kg

The LiveTouch20 is a 20 channels motorized faders digital mixer with large touch screen and USB ports. Full control is also available remotely via WIFI dongle provided to mix anywhere with your iPad. There are 12 Mic/Line inputs, 2 stereo inputs all routable via 4 mono busses, 4 stereo busses and master L/R.

The 1024x600 touch screen makes navigation simple and intuitive for studio or live applications.



App available for Apple iPad or 10" Android tablet

MIXERS



An amazing performer.

The MIXtouch8 is an 8-channel digital mixer. It offers physical or virtual control through its embedded software (HTML5).

- Direct access on each inputs in autonomy
- Integrated reader
- mp3 recorder on USB key
- Limited volume control in standalone mode
- Stereo recorder



NEW



MIXtouch8
8-channel digital interface with web control interface

Code : H10991 329€Incl. VAT



NEW



MIXtouch8-Rack
brackets for MIXtouch8

Code : H11016 32€Incl. VAT

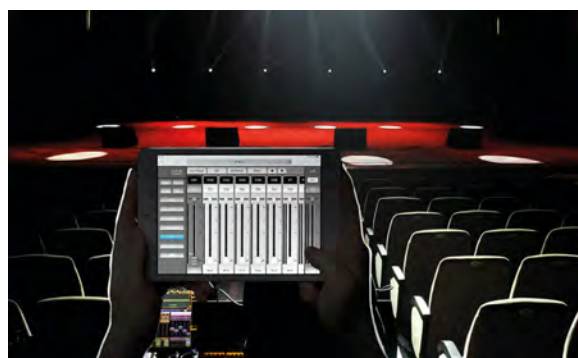
No more mobile app. Your web browser is enough.

Connect to the MIXtouch8 with its «Hotspot» function or use your local network. There is no need for an application, just use a web browser.

The MIXtouch8 is compatible with all computers, tablets or smartphones. Several people can connect to it and use its internal software.

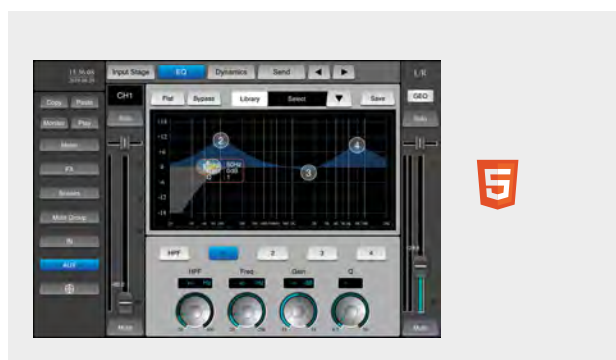

CONNECTIVITY

- Mic inputs: 4 on XLR chassis + 2 on combo chassis
- Line input: 1 sur 2 châssis Jack 6.35 et mini Jack 3.5
- Master output: 1 on 2 XLR chassis
- AUX output: 2 on 2 6.35 Jack chassis
- Footswitch: 2 on 2 6.35 Jack 6.35
- Pre-listening: 1 on Jack 6.35

TECHNICAL SPECIFICATIONS

- LINE INPUT IMPEDANCE: 3KΩ
- LINE INPUT IMPEDANCE: 20KΩ
- OUTPUT IMPEDANCE: 470Ω
- IMPEDANCE OF THE HEADPHONE OUTPUT: 100Ω
- RESIDUAL BUS NOISE: -90DBU
- MAXIMUM BUS POWER: +18DBU
- MAXIMUM VOLTAGE GAIN: 80DB INPUT TO OUTPUT
- DYNAMIC RANGE: 106DBU (20HZ-20KHZ)

- AD / DA: 24 BITS MAX / 192KHZ
- Signal processing: 40-bit floating-point processor
- Signal latency: <-1.8msec input to output
- Phantom power supply: 48V, each channel can be switched individually
- Crosstalk(@1KHz): -85 dB
- USB interface: 2 USB2.0 interface, maximum 32G supported, can be used for USB disk playback and recording, support WAV, MP3 format
- Network: WIFI connecting to USB wireless module, 1 LAN interface
- Effects: 2 Reverb and 2 Delay
- Power supply: 12V via adaptateur secteur (AC 100-240V, 50/60Hz)

CONTENTS OF THE PACKAGE

- The MIXtouch8 console
- 1 External power supply
- 1 IEC power cord
- 1 WiFi dongle
- The user guide

MIXERS

B4.2 MEDIAMIX : Perfect all-in-one solution

- + Audio mixer mixes up to 4 sources:
 - Internal media player / FM-radio + 2 external line inputs (one with 3,5mm jack for iPod, ...)
 - MIC input with high/low EQ and Talkover (adjustable damping/threshold)
 - PFL monitoring with headphones output on front panel
 - Record output via RCA/cinch
- + 2 balanced zone outputs with separate volume and max. level trimmer to control different zones.
- + Zone 2 has an additional mono switch and 100Hz high pass filter for use with small speakers.



NEW

B4.2 MEDIAMIX
Compact media player / mixer with integrated Bluetooth receiver

Code : B08400 249€^{Incl. VAT}

MIX 5.2
Mixer with 5 channels and 2 independent zones.

Code : B00119 229€^{Incl. VAT}



The internal USB-media player supports MP3, WMA and WAV files.
 RDS FM-radio with presets
 Integrated Bluetooth receiver
 IR Remote: controls media player, Radio presets, volume/mute.
 Playback of up to 3 different commercials (manual & scheduled playback) with automatic interruption of media player / tuner playback.
 Audio mixer mixes up to 4 sources:
 Internal media player / FM-radio + 2 external line inputs (one with 3,5mm jack for iPod, ...)
 MIC input with high/low EQ and Talkover (adjustable damping/threshold)
 PFL monitoring with headphones output on front panel
 Record output via RCA/cinch
 2 balanced zone outputs with separate volume and max. level trimmer to control different zones.
 Designed in Europe

Inputs
 1 microphone with Talkover on front panel
 5 microphones on back
 4 line
 2 phono

Adjustments
 3-band equaliser on each output
 3-band equaliser on microphone channel 1
 Gain adjustment for each channel
 Talkover level adjustment
 Choice of zone A or B per channel

Outputs
 Master A balanced and unbalanced
 Master B balanced and unbalanced
 Separate records A and B

LED VU-meters with 10 sections
 Power supply: AC 230V ~ 50Hz
 Dimensions: 483 x 134 x 130 mm
 Weight: 2 Kg

MIXERS



USB



The perfect mixing console

Mixing console with 4 zones

- 2 USB ports
- 6 lines through RCA
- 2 phono
- 2 microphones with Talkover
- 1 Aux on front panel

2 USB ports allowing playback and recording via a computer



MIX6usb

A compact and robust 19" mixer with stylish black design (white and blue LEDs).

Code : B00122

259€^{Incl. VAT}



Inputs
 1 USB port on channel 1 for playing and recording audio files
 2 microphones with Talkover
 5 lines,
 2 phono or 2 line,
 1 USB
 Aux on front panel

Adjustments
 3-band equaliser on each channel
 Gain adjustment for each channel
 Talkover level adjustment

Outputs
 Balanced Master
 Separate Booth and Record
 1 USB port

LED VU-meters with 10 sections
 Power supply: AC 230V ~ 50Hz
 Dimensions: 483 x 179 x 104 mm
 Weight: 5.1 Kg



SMI-84

An ideal mixer for any pub, bar, hotel, restaurant, etc.

Code : B00123

379€^{Incl. VAT}



Mixing console with 4 zones
 - 2 USB ports
 - 6 lines through RCA
 - 2 phono
 - 2 microphones with Talkover
 - 1 Aux on front panel

Level adjustment on front panel
 Microphone equaliser on front panel
 Output equaliser on back

Outputs
 Zone A, B, C through XLR mono
 Stereo Master through XLR and RCA
 All outputs are also Euroblock connectors
 Mute key on Euroblock
 Priority input on Euroblock
 2 USB ports allowing playback and recording via a computer

Power supply: AC 230V ~ 50Hz
 Dimensions: 483 x 134 x 184 mm
 Weight: 4.2 Kg



MIXERS



USB

13 inputs on 7 channels (3 mics, 5 line, 2 phonos or 2 USB, 1 AUX)

2 USB connections (USB1 is Bidirectional) for connection to PC/Mac.

Internal WMA, WAV and MP3 mediaplayer for USB memory sticks and SD card (Max 16GB / 18 folders / 2000 audio files)

3 separate balanced microphone inputs with talkover function

Treble, mid, bass controls on all channels

Assignable crossfader

1 Master output and 1 Booth output with individual level control.

Master with balanced XLR outputs

LED VU-meters on input channels and Master

Pre-fade listening with cue mix option





CLUB7-usb
DJ Mixer, 13 inputs over 7 channels
(3 microphones, 5 line, 2 phono or 2 USB,
1 auxiliary)

Code : B00125 319€^{Incl. VAT}



Inputs

- 2 USB ports on channels 2 and 3 allowing playback and recording of audio files
- 3 microphones with Talkover
- 5 lines,
- 2 phono or 2 USB,
- 1 auxiliary or Player

Integrated USB/SD reader for mp3, WAV or WMA files

Adjustments

- 3-band equaliser on each channel
- Gain adjustment for each channel
- Talkover level adjustment

Outputs

- Balanced Master
- Separate Booth and Record
- 2 USB ports

LED VU-meters for channels 1-4
Power supply: AC 230V ~ 50Hz
Dimensions: 483 x 222 x 78 mm
Weight: 4.5 Kg

MIXERS



BATTLE4-usb

DJ Mixer, 9 inputs on 4 channels (3 line inputs, 2 phono, 2 microphones, 2 USB)

Code : B00126 199€^{Incl. VAT}



Inputs
2 USB ports on channels 2 and 3 allowing playback and recording of audio files
3 line inputs
2 phono
2 microphones

Adjustments
3-band equaliser on each channel
2-band equaliser on microphone channel
Gain adjustment for each channel

Outputs
Balanced Master
Separate Booth and Record
2 USB ports

Master LED VU-meters per channel
Power supply: AC 230V – 50Hz
Dimensions: 237 x 315 x 105 mm
Weight: 3.3 Kg



DIGITAL-3

3-channel mixer with 1 microphone and 2 USB

Code : H9254 179€^{Incl. VAT}



Inputs
2 USB ports on channels 1 and 3 allowing playback and recording of audio files
3 phono through RCA
3 line through RCA
1 microphone through jack with Talkover

Adjustments
3-band equaliser on each channel
2-band equaliser on microphone channel
Gain adjustment for each channel

Outputs
Master output, high level
2 USB ports

On/off switch
LED VU-meter for Master
External power supply
Dimensions: 254 x 308 x 82.5 mm
Weight: 3.4 kg



DIGITAL-2

2-channel DJ Mixer with 1 microphone and 2 USB

Code : H8682 129€^{Incl. VAT}



Inputs
2 USB ports allowing playback and recording of audio files
2 PHONO inputs with switchable RCA connectors
2 LINE inputs with switchable RCA connectors
1 DJ mic input with jack connector and TALKOVER

Adjustments
Low/mid correction -12/+12 dB through DJmic channel
Gain and lows/mids/highs correction -15/+15 on stereo channels

Outputs
Unbalanced Master output through RCA
Headphone output
2 USB ports

General LED VU-meter with 10 sections
External power supply
Dimensions: 178 x 270 x 85 mm
Weight: 1.9 Kg



KM 4.1

Echo unit combined with a small mixer, perfect for karaoke.

Code : B00289 119€^{Incl. VAT}



Inputs
2 mic with Talkover on back
2 line

Adjustments
General 3-band equaliser
Level adjustment for each input
General level adjustment
Echo chamber adjustment (delay, repeat, echo)

Output
Unbalanced mix output

Power supply: AC 230V – 50Hz
Dimensions: 483 x 44 x 180 mm
Weight: 2 Kg

CD PLAYERS

CD/USB/SD players. Rack-mountable CD, USB or SD players for live applications in sound booth, with DJ, theatre, or entertainment-oriented functions, you will certainly find a model that suits your needs among our players.



USB 1.1 REC
CD/USB player + recorder

Code : B00365 319€^{Incl. VAT}



CD Mp3, Wave and CDA player
USB player with double USB mass-storage input (on front and back)

Lossless recording from an external source in WAV or MP3 files (bitrate: 64, 128, 192, 256 and 320kbit/s), even during playback of CD tracks or USB devices. Auto or manual recording processor: for a simple recording process without distortion

Variable pitch with Master Tone
Auto and manual BPM, perfect loop (IN/OUT/RELOOP)
AVM: Anti Vibration Memory
Auto CUE

Large screen with VFD display
ID3Tag visualisation of artists, titles and genres
Tree structure mp3 file search system.

Infrared remote control included for playback, recording, looping, search, pitch, and volume functions.

Right/left output through XLR and RCA

Dimensions: 482 x 89 x 270 mm
Weight: 4.35 kg



Mpu320
Double CD player with two USB mass-storage ports and touch-sensitive jog wheels

Code : H9681 399€^{Incl. VAT}



Double CD player, Mp3, Wave and CDA
USB player with double USB mass-storage input (on front and back)

Jog wheel with two modes: Jog scratch and pitch bend
Variable pitch with Master Tone
Auto and manual BPM, perfect loop (IN/OUT/RELOOP)
AVM: Anti Vibration Memory
Auto CUE

Large screen with VFD display
ID3Tag visualisation of artists, titles and genres
Tree structure mp3 file search system.

Xstart for cue start with crossfader on equipped mixers, Relay for continuous playback

Player dimensions 482 x 89 x 263 mm
Remote dimensions 482 x 91 x 94 mm
Weight: 5.1kg [player] 1.9kg [remote]

Mpu320

Access all your music in seconds with this DJ media player.

The dual media player Mpu320 opens the doors to a world without limits. You can now store all your tracks on hard disk while enjoying its two CD/Mp3 players and two USB ports.

Since each USB port is accessible simultaneously by both controllers, you can keep track of your tracks without changing media.

Its touch-sensitive wheels work in classic or vinyl mode and offer a feel comparable to that of a flat-panel player.

Its pitch can be adjusted from 4% to 16% (100% for audio CDs) and is equipped with a Master Tone function to vary the speed while maintaining the initial tone.

In addition, the Mpu320 offers a perfect loop with instantaneous responsiveness to the controls.

Two simultaneously accessible USB ports

No USB storage limit

Instant reactivity to orders

VINYL TURNTABLES

Back to the source. Listen to your favourite albums on high-quality vinyl, protect your collection with easy-to-use solutions offering unmatched sound quality thanks to our vinyl-dedicated range of products.



XTRM-1

Direct Super High torque motor + line out

Code : B00322

469€ Incl. VAT



Direct Drive 3-phase Super High Torque motor with extreme torque of 4.5kg/cm
Adjustable start and stop time from 0.2 to 6 seconds
3 speeds: 33, 45, 78 rpm with quartz lock and optical sensors
Pitch at $\pm 10\%$ $\pm 20\%$ $\pm 50\%$
Standard or reverse playback
2 Start/Stop buttons
White LED lighting on cartridge
Phono or Line output on back
High-quality S-shaped metal tonearm with adjustable height.
Special anti-resonant frame
Tall adjustable support legs
Dimensions: 450 x 353 x 86 mm
Weight: 12 kg
Comes with cartridge holder, felt mat and 45 rpm adapter



TT-CASE

High-quality modern flight-case for DJ turntables (T2, T3, X-TRM1, SL1200, etc.).

Code : B03206

69€ Incl. VAT



High-quality modern flight-case for DJ turntables (T2, T3, X-TRM1, SL1200, ...).
2 butterfly latches, solid handle, interior finish in shock-absorbing foam rubber



MICROPHONES

RP1 : Cardioid dynamic microphone

Taking its place among the very best

We put so much efforts into the RP1 that we created a microphone beyond all our expectations.

Its unidirectional membrane was handpicked among hundreds for its dynamism and source fidelity. Designed for singers, it will transcend your voice on any stage.

- + Designed for live singing performances
- + Powerful, crystal-clear output
- + Very resistant metal housing
- + Supplied with a pouch bag and a clip



RP1
Dynamic cardioid microphone for voice

Code : H9654 39,90€^{Incl. VAT}



Use: Vocals
Type: Dynamic cardioid
Finish: Moulded aluminium body, reinforced anti-shock grill and pop filter
Connection: XLR
Impedance: 600Ω +/-30% @ 1kHz
Frequency response: 70Hz - 16kHz
Sensitivity: -53dB +/-3dB
Weight: 360 g
Dimensions: 180 x 53mm



RS1
Dynamic microphone for voice

Code : H9653 29,90€^{Incl. VAT}



Use: Vocals
Type: Dynamic cardioid
Finish: Moulded aluminium body, reinforced anti-shock grill and pop filter
Connection: XLR
Impedance: 600Ω +/-30% @ 1kHz
Frequency response: 40Hz - 16kHz
Sensitivity: -52dB +/-3dB
Weight: 355 g
Dimensions: 185 x 50 mm



JB27
Professional microphone

Code : B00410 52,90€^{Incl. VAT}



Use: Vocals
Type: Dynamic cardioid
Finish: Moulded aluminium body, reinforced anti-shock grill and pop filter with ON/OFF
Connection: XLR
Impedance: 250Ω
Frequency response: 50Hz - 18kHz
Sensitivity: -72dB
Comes with case, clamp and 6m XLR to mono jack cable



JB10
Professional dynamic microphone

Code : B00402 36,90€^{Incl. VAT}



Use: Dynamic microphone for entertainment and speech
Type: Dynamic cardioid
Finish: Metal body and solid build with ON/OFF button
Connection: XLR
Impedance: 500 Ω
Frequency response: 70Hz - 14kHz
Sensitivity: -75dB
Comes with case, clamp and 6m XLR to mono jack cable

MICROPHONES



RS1 : Dynamic cardioid microphone

Outstanding in any case

The RS1 is a very versatile and intuitive microphone, giving its best in any situation.

Its membrane was built to absorb the movements and hands noises while its aluminium housing and steel grille make it perfect for stages.

- + Very resistant
- + Movement interferences canceller
- + Supplied with a pouch bag and a clip





DMC62
Dynamic microphone for entertainment and speech

Code : H9652 24,90€^{Incl. VAT}



Use: Dynamic microphone for entertainment and speech
 Type: Dynamic cardioid
 Finish: Metal body and solid build with ON/OFF button
 Connection: XLR
 Impedance: 500 Ω
 Frequency response: 80Hz - 15kHz
 Sensitivity: -54dB
 Comes with case, clamp and 6m XLR to mono jack cable



JB5
Semi-professional dynamic microphone for DJ, voice or music

Code : B00408 17,90€^{Incl. VAT}



Use: Dynamic microphone for entertainment and speech
 Type: Dynamic cardioid
 Finish: Metal body and solid build with ON/OFF button
 Connection: moulded cable with jack connector
 Impedance: 600 Ω
 Frequency response: 100Hz - 12kHz
 Sensitivity: -74dB
 Comes with 2m mono jack cable



JB30
Gooseneck microphone

Code : B00411 54,90€^{Incl. VAT}



Use: Dynamic gooseneck microphone for speech
 Type: Unidirectional microphone
 Finish: 30cm metal gooseneck with ON/OFF button
 Connection: XLR
 Impedance: 500 Ω
 Frequency response: 80Hz - 14kHz
 Sensitivity: -74dB



JB33
Suitable for conferences, etc.

Code : B00406 39€^{Incl. VAT}



Use: Conference gooseneck microphone
 Type: Condenser Electret 1.5V
 Finish: 23cm metal gooseneck with ON/Standby/OFF button
 Connection: 3.5 and 6.35 jack
 Impedance: 1000 Ω
 Frequency response: 70Hz - 16kHz
 Sensitivity: -66dB

UHF410 RANGE

The UHF410 range benefits from the latest technological developments for optimal transmission quality. This range meets European requirements.

It is now available in two frequency ranges:

- F5 for the 500MHz range
- F8 for the 800 MHz range

Please check the authorized frequency bands in your area.

More information on www.audiophony.com



NEW

500
MHz
range



UHF410-Base-F5
UHF true diversity receiver with auto scan and sync function

Code : H11026
219€Incl. VAT



NEW

500
MHz
range



UHF410-Hand-F5
Dynamic handheld microphone transmitter

Code : H11027
99€Incl. VAT



NEW

500
MHz
range



UHF410-Body-F5
UHF diversity waistband transmitters

Code : H11028
99€Incl. VAT



True Diversity receiver
Frequency ranges UHF 514-564 MHz
4G compatible
 Programmed frequencies with auto-scan function
 Presets for 8 groups, 16 channels
 Total channels: 997
 LCD display: frequency, group, channel, RF & AF
 Balanced and unbalanced audio output through XLR and 6.35 mono jack
 Line or Mic level
 Volume level adjusted through rotary switch on front
 Detachable BNC antennae, multiple accessories available
 Power supply: 12V DC (adapter provided)
 Dimensions: 200 x 42 x 183mm (rack-mountable 19 inch by two)

Dynamic handheld microphone transmitter
Frequency ranges UHF 514-564 MHz
4G compatible
 Output power: 35mW (max.)
 40 programmed frequencies with SYNC function
 LCD display: channel, battery level
 Power supply: 2 AA 1.5V batteries (not included)
 Average battery life: 10 hours
 Dimensions: 260 x 54mm diameter

Frequency ranges UHF 514-564 MHz
4G compatible
 Output power: 35mW (max.)
 40 channels with auto-scan function
 LCD display: channel, battery level
 Mic input through mini XLR
 Gain level -20/-10/0 dB
 Power supply: 2x AA type 1.5V batteries (not included)
 Battery life: 10 hours on average
 Dimensions: 98 x 65 x 25mm (+ 75mm for antenna)

UHF410 RANGE



800 MHz range



UHF410-Base-F8
UHF true diversity receiver with auto scan and sync function

Code : H10271 219€^{Incl. VAT}



True Diversity receiver
Frequency ranges UHF 823 – 832 and 863 – 865 MHz,
Programmed frequencies with auto-scan function
Presets for 8 groups, 12 channels
Total channels : 442
LCD display: frequency, group, channel, RF & AF
Balanced and unbalanced audio output through XLR and 6.35 mono jack
Line or Mic level
Volume level adjusted through rotary switch on front
Detachable BNC antennae, multiple accessories available
Power supply: 12V DC (adapter provided)
Dimensions: 200 x 42 x 183mm (rack-mountable 19 inch by two)

800 MHz range



UHF410-Hand-F8
Dynamic handheld microphone transmitter

Code : H10272 99€^{Incl. VAT}



Dynamic handheld microphone transmitter
True Diversity transmitter
Frequency ranges UHF 823 – 832 and 863 – 865 MHz
Output power: 10mW (max.)
40 programmed frequencies with SYNC function
LCD display: channel, battery level
Power supply: 2 AA 1.5V batteries (not included)
Average battery life: 10 hours
Dimensions: 260 x 54mm diameter

800 MHz range



UHF410-Body-F8
UHF diversity waistband transmitters

Code : H10273 99€^{Incl. VAT}



True Diversity Transmitter
Frequency ranges UHF 823 – 832 and 863 – 865 MHz
Output power: 10mW (max.)
40 channels with auto-scan function
LCD display: channel, battery level
Mic input through mini XLR
Gain level -10/0/+10dB
Power supply: 2x AA type 1.5V batteries (not included)
Battery life: 10 hours on average
Dimensions: 98 x 65 x 25mm (+ 75mm for antenna)



UHF410-Head
Sweatproof headset microphone

Code : H10274 35€^{Incl. VAT}



Sweatproof headset electret condenser microphone, ideal for sport clubs
Sensitivity: -47 ±4dB
Polarity: Unidirectional cardioid
Frequency response: 100Hz - 10KHz
Operating voltage: 1.5V
Power consumption: 0.5mA max.
Signal to noise ratio: Higher than 60dB
Accessories included: Windscreen
Connectivity: Mini XLR



BODYPOCKET
Neoprene waistband for UHF-BODY transmitter

Code : H10484 19€^{Incl. VAT}



Compatible with most transmitters on the market
Ideal for sports clubs



WHS-20
Mini XLR condenser headset microphone

Code : B00442 39€^{Incl. VAT}



Headset microphone for musicians, teachers and fitness clubs
Must be paired with a WBP- 20 transmitter
Mini XLR connector
Comes with windscreen and adjustable headband
Unidirectional condenser capsule
Frequency response: 100Hz to 16kHz
S/N: > 60dB
Impedance: 2.2 kOhms



UHF410-Lava
Discrete lavalier condenser microphone

Code : H10275 29€^{Incl. VAT}



Miniature lavalier electret condenser microphone
Sensitivity: -47 ±4dB
Polarity: Omnidirectional cardioid
Frequency response: 50Hz - 10KHz
Operating voltage: 1.5V
Power consumption: 0.5mA max.
Signal to noise ratio: Higher than 58dB
Accessories included: Windscreen and fastening pin
Connectivity: Mini XLR
Dimensions: 37 x 5,5mm diameter



RW2
Micro headband, condensing cell, light color

Code : H10946 39,90€^{Incl. VAT}



Type: Condenser Omni-directional
Connection: Mini XLR
Imp.dance : 2.2K Ohms @ 1KHz
Frequency response: 70Hz - 16kHz
Sensitivity: -42dB +/-3dB
Weight: 21 g

ANTENNA UHF410



UHF-410-Boost
Booster antenna with BNC connector

Code : H10276 35€^{Incl. VAT}



Gain from 9 dB +/-1dB
Frequency range: 500 - 950 MHz
Operating voltage: 8V
Impedance 50Ω



UHF410-Hold
Antenna support with BNC connector

Code : H10277 16€^{Incl. VAT}



5/8" threading for microphone stand and male/male BNC connector



UHF410-Split
2-in-1 Splitter IN/OUT with BNC connector

Code : H10278 65€^{Incl. VAT}



Frequency range: 500 - 1000 MHz
Stationary wave report (VSWR): < 2
Input impedance: 50 Ω
Isolation: 18dB
Loss: < 3dB
Connectors: BNC
Dimensions: 77 x 64 x 26 mm



UHF410-BNC1
BNC/BNC connector for extension

Code : H10641 4€^{Incl. VAT}



UHF410-Rall1m
BNC/BNC 1 metre antenna extension cable

Code : H10280 17€^{Incl. VAT}



UHF410-Rall10m
BNC/BNC 10 metre antenna extension cable

Code : H10281 69€^{Incl. VAT}



UHF410-BNC2
BNC/BNC connector for bracket

Code : H10639 4€^{Incl. VAT}



UHF410-Rack
Long bracket for receiver

Code : H10640 7€^{Incl. VAT}



UHF410-Ant
Long range directional antenna with BNC connector

Code : H10279 299€^{Incl. VAT}



Frequency range: 500 - 1000 MHz
Beam width:
80° E-plane, 140° H-plane
Impedance: 50 Ω
Connector: BNC
Dimensions: 295 x 210 x 31 mm

UHF410 PACK



800 MHz range



PACK-UHF410-Lava-F8

Code : H10284 319€^{Incl. VAT}

audiophony
EQUIPMENTS

Pack including:
1 UHF410-Base receiver
1 UHF410-Body waistband transmitter
1 UHF410-Lava lavalier microphone
1 carrying case

800 MHz range



PACK-UHF410-Hand-F8

Code : H10282 289€^{Incl. VAT}

audiophony
EQUIPMENTS

Pack including:
1 UHF410-Base receiver
1 UHF410-Hand handheld microphone
1 carrying case

800 MHz range



PACK-UHF410-Head-F8

Code : H10283 319€^{Incl. VAT}

audiophony
EQUIPMENTS

Pack including:
1 UHF410-Base receiver
1 UHF410-Body waistband transmitter
1 UHF410-Head headset microphone
1 carrying case

500 MHz range



PACK-UHF410-Lava-F5

Code : H11144 319€^{Incl. VAT}

audiophony
EQUIPMENTS

Pack including:
1 UHF410-Base receiver
1 UHF410-Body waistband transmitter
1 UHF410-Lava lavalier microphone
1 carrying case

500 MHz range



PACK-UHF410-Hand-F5

Code : H11142 289€^{Incl. VAT}

audiophony
EQUIPMENTS

Pack including:
1 UHF410-Base receiver
1 UHF410-Hand handheld microphone
1 carrying case

500 MHz range



PACK-UHF410-Head-F5

Code : H11143 319€^{Incl. VAT}

audiophony
EQUIPMENTS

Pack including:
1 UHF410-Base receiver
1 UHF410-Body waistband transmitter
1 UHF410-Head headset microphone
1 carrying case

GO RANGE

The GO UHF microphone range is equipped with the latest technological developments for optimal transmission quality.

Equipped with high quality electronics, transmitters and receivers now allow the use of 4 microphones simultaneously with optimal reception quality.

Now available in two frequency ranges:

→F5 for the 500MHz range

→F8 for the 800 MHz range

Please check the authorized frequency bands in your area.

More information on www.audiophony.com



NEW **500 MHz range**



GO-Mono-F5
UHF diversity receiver, 16 frequencies for 1 transmitter

Code : H11029 99€^{Incl. VAT}



UHF 16-frequency receiver
Frequency ranges UHF 514-542 MHz, 4G compatible
Diversity system for reception free of micro-cuts.
Adjustable squelch for parasite absorption
Simultaneous operation of 4 receivers (4 mics)
Adjustable antennae on front
Average range 70m in ideal conditions
Balanced XLR and unbalanced jack outputs
Rack-mountable by two via FREE-RACK (optional)
Dimensions: 130 x 36 x 92 mm

NEW **500 MHz range**



GO-Hand-F5
UHF transmitter handheld condenser microphone

Code : H11030 79€^{Incl. VAT}



Handheld microphone only
Must be paired with a GO-MONO receiver
Frequency ranges UHF 514-542 MHz, 4G compatible
High-end Electret condenser capsule
Distortion rate lower than 1% @ 1kHz
Works with AA-type 1.5V batteries
Dimensions: 237 x 58 mm

NEW **500 MHz range**



GO-Body-F5
Waist transmitter housing for lavalier or headset microphone

Code : H11031 59€^{Incl. VAT}



Pocket UHF transmitter 16 frequencies
Frequency ranges UHF 514-542 MHz, 4G compatible
Mini XLR connector
Adjustable impedance on either Line or Mic position
Works with AA-type 1.5V batteries
Dimensions: 65 x 100 x 27 mm



RW2
Micro headband, condensing cell, flesh colour

Code : H10946 39,90€^{Incl. VAT}



Type: Condenser Omni-directional
Connection: Mini XLR
Impedance: 2.2K Ohms @ 1KHz
Frequency response: 70Hz - 16kHz
Sensitivity: -42dB +/-3dB
Weight: 21 g

GO RANGE



800 MHz range



GO-Mono-F8

UHF diversity receiver, 16 frequencies for 1 transmitter

Code : H9988 99€^{Incl. VAT}



UHF 16-frequency receiver
 Frequency ranges UHF 823 - 832 and 863 - 865 MHz
 Diversity system for reception free of micro-cuts.
 Adjustable squelch for parasite absorption
 Simultaneous operation of 4 receivers (4 mics)
 Adjustable antennae on front
 Average range 70m in ideal conditions
 Balanced XLR and unbalanced jack outputs
 Rack-mountable by two via FREE-RACK (optional)
 Dimensions: 130 x 36 x 92 mm

800 MHz range



GO-Hand-F8

UHF transmitter handheld condenser microphone

Code : H9989 79€^{Incl. VAT}



Handheld microphone only
 Frequency ranges UHF 823 - 832 and 863 - 865 MHz
 Must be paired with a GO-MONO receiver
 High-end Electret condenser capsule
 Distortion rate lower than 1% @ 1kHz
 Works with AA-type 1.5V batteries
 Dimensions: 237 x 58 mm

800 MHz range



GO-Body-F8

Waist transmitter housing for lavalier or headset microphone

Code : H9990 59€^{Incl. VAT}



Pocket UHF transmitter 16 frequencies
 Frequency ranges UHF 823 - 832 and 863 - 865 MHz
 Mini XLR connector
 Adjustable impedance on either Line or Mic position
 Works with AA-type 1.5V batteries
 Dimensions: 65 x 100 x 27 mm



GOHead

Headband electret microphone - mini XLR

Code : H9991 35€^{Incl. VAT}



Headband microphone only
 Must be combined with a GO-BODY transmitter and a GO-MONO receiver
 Mini XLR connector
 Supplied with a microphone windshield and an adjustable headband
 Unidirectional electret
 Frequency response : 100 Hz at 16 kHz
 S/N : → 60 dB



GOLava

Lavalier microphone - mini XLR

Code : H9992 29€^{Incl. VAT}



Tie-clip microphone only
 Must be combined with a GO-BODY transmitter and a GO-MONO receiver
 Mini XLR connector
 Supplied with a microphone windshield and a tie clip
 Unidirectional electret
 Frequency response : 100 Hz at 16 kHz
 S/N : → 60 dB



RP-WMIC

19" adapter for 1 or 2 receivers Go

Code : B00437 39€^{Incl. VAT}



19" adapter for 1 or 2 receivers (WMS-1 or WBS-2 set).



FREE-RACK

19 inch rack bracket for 2 GO receivers

Code : H9374 39€^{Incl. VAT}



Material: Steel
 Finish: Black paint



MICRO CASE 3U

Rack 19" 3U 230mm/300mm

Code : B03221 119€^{Incl. VAT}



Flight case for 19-inch HF microphone receiver.
 Depth 230mm (300mm with cover)

GO PACK

800 MHz range



PACK GO-LAVA-F8

Code : H10000 179€^{Incl. VAT}

audiophony
EQUIPMENTS

Pack including:
 1 GO-MONO receiver
 1 GO-MONO waist transmitter
 1 GO-Lava lavalier mic

800 MHz range



PACK GO-HEAD-F8

Code : H10001 179€^{Incl. VAT}

audiophony
EQUIPMENTS

Pack including:
 1 GO-MONO receiver
 1 GO-MONO waist transmitter
 1 GO-Head headset microphone

800 MHz range



PACK GO-HAND-F8

Code : H9999 169€^{Incl. VAT}

audiophony
EQUIPMENTS

Pack including:
 1 GO-MONO receiver
 1 GO-Hand handheld microphone

500 MHz range



PACK GO-LAVA-F5

Code : H11147 179€^{Incl. VAT}

audiophony
EQUIPMENTS

Pack including:
 1 GO-MONO receiver
 1 GO-MONO waist transmitter
 1 GO-Lava lavalier mic

500 MHz range



PACK GO-HEAD-F5

Code : H11146 179€^{Incl. VAT}

audiophony
EQUIPMENTS

Pack including:
 1 GO-MONO receiver
 1 GO-MONO waist transmitter
 1 GO-Head headset microphone

500 MHz range



PACK GO-HAND-F5

Code : H11145 169€^{Incl. VAT}

audiophony
EQUIPMENTS

Pack including:
 1 GO-MONO receiver
 1 GO-Hand handheld microphone

AUDIO HEADPHONES



HPS-2
Professional DJ headphones

Code : B00508 69€^{Incl. VAT}



HP2000 PRO
Professional high-performance earphones for DJ.

Code : B00505 32,90€^{Incl. VAT}



HEADZ ONE
The ultimate multimedia headphone

Code : B08300 39€^{Incl. VAT}



HeadZ Fuchsia
The best of light earphones + mic with outstanding sound quality for your smartphone, tablet, laptop, etc.

Code : B00512 22,90€^{Incl. VAT}



Transducer type: Dynamic
Speaker diameter: 50 mm
Impedance: 29 Ω
Sensitivity: 101 dB +/- 3 dB
Admissible power: 1000 mW
Frequency response: 15 Hz - 22 kHz
Cable: 3m twisted cable and smartphone cable with integrated microphone
Connections: 3.5 mm with 6.35 mm adapter supplied
Weight: 280 g

Driver diameter: 57 mm
Impedance: 64 Ω
Sensitivity: 107 dB
Maximum power: 3500 mW
Frequency response: 5 - 30kHz
Cable: 3m coiled cable with 3.5/6.35 jack adapter and right-angled 6.35
Carrying case and replacement ear pads included
Weight: 290 g

Specifications Headphones:
Frequency Response: 10 - 20.000Hz
SPL: 97dB ± 3dB at 1mW
Impedance: 32Ω
Weight: 200g (without cable)
Specifications Microphone:
Type: Omnidirectional Condenser Microphone
Frequency Response: 50Hz - 18KHz
Sensitivity: -62dB ± 3dB at 1 KHz
Impedance: 8.2KΩ
Link output

Headphones for smartphone, tablet or laptop
Driver diameter: 38 mm
Impedance: 64 Ω
Sensitivity: 98 dB
Frequency response: 10 - 20 kHz
Cable: with integrated microphone and computer adapter
Weight: 160 g
Link output
Fuchsia pink colour



HEADZ ONE and HEADZ FUCHSIA offer a rather unique function . It is the LINK output that allows you to connect a second headphone to the first one. So 2 people can listen to the same source.





GEAR OF ART
CR80A-COMBO MK2

PORTABLE SOUND SYSTEMS

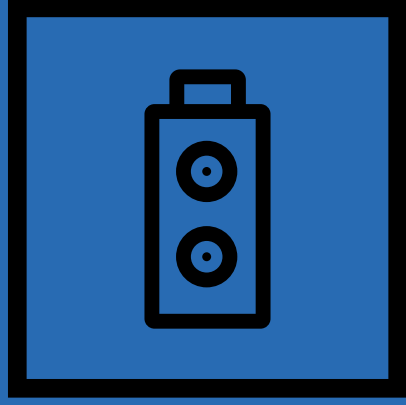

PORTABLE SOUND SYSTEMS

CR25A-COMBO

12" 250W portable speaker Bluetooth® compatible, with a USB player and 2 UHF microphone

- + Performance
- + Power
- + Robustness

The CR25A-COMBO is a powerful all-in-one sound system producing a high-quality sound output, adapted to any mobile installation.

It features a USB/SD reader, a Bluetooth® receiver, two UHF handheld microphone and a mixer allowing you to plug two extra microphones and an external source. In brief: it is complete, powerful, and easy to use.

But it is also easy to carry, thanks to its built-in trolley. The icing on the cake: its built-in storage compartment has enough room for two mic and remains discreet.

Key points :

- Battery level display by LED display
- Simultaneous charging and use
- Automatic shutdown in case of too low battery level
- Storage compartment for two microphones and cables
- Retractable handle and wheels
- supplied with two UHF hand mic
- Optional headset microphone available



Available in two frequency ranges :

- F5 for the 500MHz range
- F8 for the 800 MHz range

Please check the authorized frequency bands in your area.

More information on www.audiophony.com



800 MHz range



CR25A-COMBO-F8
Battery-powered portable sound system, 250 W RMS with BT, USB reader and two UHF microphones

Code : H10789 999€^{incl. VAT}



NEW

500 MHz range



CR25A-COMBO-F5
Battery-powered portable sound system, 250 W RMS with BT, USB reader and two UHF microphones

Code : H11025 999€^{incl. VAT}



COV-CR25A
Protective cover for CR25A-COMBO

Code : H10791 109€^{incl. VAT}



Power rating: 250 W (2 channels)
Loudspeaker: 12" loudspeaker + 1.35" driver
Microphones supplied : Two hand-held UHF microphones, 16 selectable frequencies
Frequency ranges: UHF 823 to 832 MHz and 863 to 865 MHz
Free UHF microphone slot: No
Source: USB/SD reader + Bluetooth®
Free music player slot: No
Inputs: Two LINE inputs on 3.5 mm stereo jack or RCA, two MIC/LINE inputs on combined XLR/Jack
Echo chamber with adjustable delay
Outputs: One LINE level on 6.35 mm TRS jack
Battery: 2 x 18 V / 7 Ah NP
Battery life: 5 hours (average)
Weight: 24.5 kg
Dimensions: 615 x 350 x 395mm
Accessories supplied: Built-in trolley, infrared remote control

Power rating: 250 W (2 channels)
Loudspeaker: 12" loudspeaker + 1.35" driver
Microphones supplied : Two hand-held UHF microphones, 16 selectable frequencies
Frequency ranges: UHF 514-542 MHz
4G-compatible
Free UHF microphone slot: No
Source: USB/SD reader + Bluetooth®
Free music player slot: No
Inputs: Two LINE inputs on 3.5 mm stereo jack or RCA, two MIC/LINE inputs on combined XLR/Jack
Echo chamber with adjustable delay
Outputs: One LINE level on 6.35 mm TRS jack
Battery: 2 x 18 V / 7 Ah NP
Battery life: 5 hours (average)
Weight: 24.5 kg
Dimensions: 615 x 350 x 395mm
Accessories supplied: Built-in trolley, infrared remote control

NEW



Recept F5
UHF receiver 514-542 MHz

Code : H11019 79€^{incl. VAT}



16 selectable frequencies UHF 514-542 MHz.
Compatible CR25A-COMBO-F5, CR12A-COMBO-F5

NEW



Emet-Hand F5
UHF Handheld Microphone 514-542 MHz

Code : H11020 79€^{incl. VAT}



Dynamic hand-held UHF microphone
16 selectable frequencies (UHF 514-542 MHz) - 35 mW
Uses two 1.5 V AA batteries (not supplied)
Compatible CR25A-COMBO-F5, CR12A-COMBO-F5

NEW



Emet-Body F5
UHF Headset Transmitter 514-542 MHz

Code : H11021 69€^{incl. VAT}



16 selectable frequencies UHF 514-542 MHz - 35 mW
Uses two 1.5 V AA batteries (not supplied)
Compatible CR25A-COMBO-F5, CR12A-COMBO-F5

NEW



Ant F5
TNC antenna 514-542 MHz

Code : H11022 9€^{incl. VAT}



CR12A-COMBO

Le renouveau de la sonorisation tout-terrain
An off-road system



Available in two frequency ranges :

→F5 for the 500MHz range

→F8 for the 800 MHz range

Please check the authorized frequency bands in your area.

More information on www.audiophony.com



800 MHz range



CR12A-COMBO-F8

Battery-powered portable sound system, 120 W RMS with BT, USB reader and two UHF microphones

Code : H10209

699€^{incl. VAT}



NEW

500 MHz range



CR12A-COMBO-F5

Battery-powered portable sound system, 120 W RMS with BT, USB reader and two UHF microphones

Code : H11024

699€^{incl. VAT}



800 MHz range



CR-12AHEADset

Transmitter + headset microphone for CR12A-COMBO

Code : H10210

99€^{incl. VAT}



COV-CR12A

Case for CR12A-COMBO loudspeaker

Code : H10208

79€^{incl. VAT}



Power rating: 120 W [2 channels]
Loudspeaker: 10" loudspeaker + 1" driver
Microphones supplied : Two hand-held UHF microphones, 16 selectable frequencies
Frequency ranges: UHF 823 to 832 MHz and 863 to 865 MHz
Free UHF microphone slot: No
Source: USB/SD reader + Bluetooth®
Free music player slot: No
Inputs: Two LINE inputs on 3.5 mm stereo jack or RCA, two MIC/LINE inputs on combined XLR/Jack
Outputs: One LINE level on 6.35 mm TRS jack
Battery: 2 x 12 V / 5 Ah NP
Battery life: 6 hours (average)
Weight: 17.3 kg
Dimensions: 550 x 340 x 300 mm
Accessories supplied: Built-in trolley, infrared remote control

Options:
COV-CR12A (protective cover)
CR12A-HEADSET (pocket UHF transmitter and headset microphone)

Power rating: 120 W [2 channels]
Loudspeaker: 10" loudspeaker + 1" driver
Microphones supplied : Two hand-held UHF microphones, 16 selectable frequencies
4G-compatible frequency ranges: UHF 514-542 MHz
Free UHF microphone slot: No
Source: USB/SD reader + Bluetooth®
Free music player slot: No
Inputs: Two LINE inputs on 3.5 mm stereo jack or RCA, two MIC/LINE inputs on combined XLR/Jack
Outputs: One LINE level on 6.35 mm TRS jack
Battery: 2 x 12 V / 5 Ah NP
Battery life: 6 hours (average)
Weight: 17.3 kg
Dimensions: 550 x 340 x 300 mm
Accessories supplied: Built-in trolley, infrared remote control

Options:
COV-CR12A (protective cover)
CR12A-HEADSET (pocket UHF transmitter and headset microphone)

Compatible with the CR12A-COMBO portable sound system
16 selectable frequencies [823-832 and 863-865 MHz] - 10 mW
Type: Cardioid condenser microphone
Frequency response: 70 - 18 kHz

PORTABLE SOUND SYSTEMS



Equipped with an 8-frequency handheld microphone on 823-832/863-865 MHz (MK2 version) equipped with a HF receiver compatible with the 4G telephone network.



800 MHz range



CR80A-COMBO MK2

Bluetooth® portable sound system with USB reader and HF microphone

Code : H10983

469€ incl. VAT



Loudspeaker: 6.5" loudspeaker + 1" titanium driver, total impedance: 4 Ohms
 Power: 80W RMS / 160 max Class D amplifier
 Frequency response: 80 - 20k Hz
 Sound pressure level: 113 dB SPL max
 Microphone:
 - HF microphone 8 channel UHF
 - Handheld cardioid-dynamic microphone
 - Frequency range UHF 823-832 / 863-865 Mhz - 10 mW

Reader Built-in USB key reader and Bluetooth® receiver
 Supplied with an infrared remote control Bluetooth®:
 - The player features a Bluetooth® receiver - Type V4.2 AVRCP, with an excellent, close-to-digital audio transmission

Finish:
 - Polypropylene housing, metal mesh grill.
 - C36 mounting plate for speaker stands

Dimensions (in mm) 375 x 240 x 210
 Net weight (incl. batteries) 5,9 kg
 Internal battery:
 - Battery 1x DC22,2V 2,2AH Li-ion
 - Autonomy 5 hours depending on the volume
 - Charging time 6 hours to recharge the two batteries

Power management:
 - LED display to indicate the charge level.
 - Charge it and use it at the same time.
 - Automatic shutdown if the battery level is too low

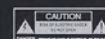

MADE IN CHINA
 Distributed by: BETHOVEN S.A.S
 Jean Collet - Snc
 91230 BRUNY - FRANCE



PPA-121

Powerful professional portable speaker with USB/SD reader, FM, one LINE and two MIC inputs

Code : B00191

269€^{Incl. VAT}



Power rating: 250 W (2-way)
Loudspeaker: 12" loudspeaker + 1.35" driver
Microphone supplied: No
Source: USB/SDHC reader + FM tuner
Inputs: One LINE input on RCA/XLR, two MIC inputs on XLR/jack
Outputs: 1 LINE level on XL
Battery: No
Weight: 15 kg
Dimensions: 580 x 372 x 315 mm
Accessories included: Infrared remote control



PPA-101

Portable sound system, 50 W, with BT, FM, USB/SD reader and two UHF microphones; supplied without battery

Code : B00195

439€^{Incl. VAT}



Power rating: 50 W (2-way)
Loudspeaker: 10" loudspeaker + 1" driver
Microphones supplied: One hand-held UHF microphone (864,80 MHz) + one headset microphone with Pocket UHF transmitter (864,80MHz)
Source: USB/SD reader + Bluetooth®+ FM tuner
Inputs: One LINE input on 3,5 mm stereo jack, RCA or XLR, one MIC input on combined XLR/jack
Outputs: 1 LINE level on XLR
Battery: 1x 12 V 7 Ah (optional - code B00198)
Battery life: 6 hours (average)
Weight: 15.5 kg without battery
Dimensions: 550 x 325 x 280 mm
Accessories supplied: Built-in trolley, 12V car power cable, infrared remote control

Options:
TOURING BAG-PPA-101 (protective cover)



Hand-held UHF microphone for PPA-101 (864,80 MHz)

Code : B00197

49€^{Incl. VAT}



Battery for PPA-101

12 V, 7 Ah lead-acid battery

Code : B00198

47,90€^{Incl. VAT}



TOURING BAG - PPA-101

Protective bag for PPA-101

Code : B00598

39€^{Incl. VAT}





COMMERCIAL AUDIO

DISTRIBUTION
AMPLIFIERS
SOURCES
MIXERS
MATRICES
WEBRADIO
HEARING LOOP SYSTEMS

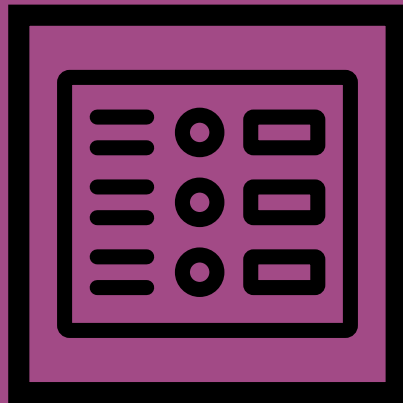

BROADCASTING



KIOSK45

Discrete speaker with IP66 45W terminal
6.5inch 100V- green

Code : H10966

199€^{Incl. VAT}



STONE45

Discrete rock speaker IP66 45W 6.5inch
100V- grey

Code : H10967

179€^{Incl. VAT}



Power outputs : 45W
Voltage : 100 V
Components : 1 x 6,5" + 1 x 3"
Sensitivity (1W/1m): 86 dB, +/-2dB
Frequency response : 80-10 000 Hz
Material : Aluminium (Heavy damage proof finish)
Waterproof level : IP66
Dimensions : 240 mm (diam) x 440 mm
Weight : 6 Kg

Power outputs : 45W
Voltage : 100 V
Components : 6,5" + 1"
Sensitivity (1W/1m): 88 dB, +/-3dB
Frequency response : 80-16 000 Hz
Material : Aluminium (Heavy damage proof finish)
Waterproof level : IP66
Dimensions : 250x360x420 mm
Weight : 7 Kg



The JAVA, EHP-IP and BORNEO speakers are particularly suitable for their sound qualities which make them ideal tools for diffusing ambient music. The tropicalized finish allows them to be used on terraces as long as they are protected from direct exposure to rain.



JAVA315b (1 pair)

Tropicalized speaker 6' 100V 7.5-60W/8
Ohms-white

Code : H10921

99€^{Incl. VAT}



JAVA315w (1 pair)

Tropicalized speaker 100V 7.5/15W/16
Ohms - white

Code : H10922

99€^{Incl. VAT}



JAVA530b (1 pair)

Tropicalized speaker 100V 15-30W/16
Ohms - black

Code : H10923

219€^{Incl. VAT}



JAVA530w (1 pair)

Tropicalized speaker 100V 15-30W/16
Ohms - white

Code : H10924

219€^{Incl. VAT}



Power outputs : 7,5 / 15 W
Voltage : 100 V 16 Ohms
Components : 3" + 1"
Sensitivity (1W/1m): 90 dB, +/-3dB
Frequency response : 90 - 20 000 Hz
Material : Plastic enclosure and aluminium grille
Holding : Wallmount bracket
Connectors : Waterproof cable on gland IP55
Power rotary knob : 15W 16Ω // 7,5 / 15 W 100V
Dimensions : 112x 158 x 160 (H) mm
Weight : 0,9 Kg

Power outputs : 7,5 / 15 W
Voltage : 100 V 16 Ohms
Components : 3" + 1"
Sensitivity (1W/1m): 90 dB, +/-3dB
Frequency response : 90 - 20 000 Hz
Material : Plastic enclosure and aluminium grille
Holding : Wallmount bracket
Connectors : Waterproof cable on gland IP55
Power rotary knob : 15W 16Ω // 7,5 / 15 W 100V
Dimensions : 112x 158 x 160 (H) mm
Weight : 0,9 Kg

Power outputs : 15 / 30 W
Voltage : 100 V 16 Ohms
Components : 5" + 1"
Sensitivity (1W/1m): 88 dB, +/-3dB
Frequency response : 60 - 20 000 Hz
Material : Plastic enclosure and aluminium grille
Holding : Wallmount bracket
Connectors : Waterproof cable on gland IP55
Power rotary knob : 30W 16Ω // 15 / 30 W 100V
Dimensions : 178x 236 x 255 (H) mm
Weight : 2,38 Kg

Power outputs : 15 / 30 W
Voltage : 100 V 16 Ohms
Components : 5" + 1"
Sensitivity (1W/1m): 88 dB, +/-3dB
Frequency response : 60 - 20 000 Hz
Material : Plastic enclosure and aluminium grille
Holding : Wallmount bracket
Connectors : Waterproof cable on gland IP55
Power rotary knob : 30W 16Ω // 15 / 30 W 100V
Dimensions : 178x 236 x 255 (H) mm
Weight : 2,38 Kg

BROADCASTING



Borneo660b

Tropicalised installation speaker 60 Watts
2-way - 8 Ohms/100 V - Black

Code : H9920

229€^{Incl. VAT}



Power rating: 60 W RMS
Available power:
60 W/20 W/15 W/10 W/5 W
8 Ohms/100 V
Tweeter: 1 inch
Woofer: 6.5 inch
Frequency response: 45 Hz - 20 kHz
Sensitivity (1 W @ 1 m): 89 dB
Attachment: swivel bracket
Humidity-resistant tropicalised speaker.
Dimensions: 340 x 220 x 200 mm
Net weight: 3.8 kg
Unit price - Sold by 2pcs



Borneo660w

Tropicalised installation speaker 60 Watts
2-way - 8 Ohms/100 V - White

Code : H9911

229€^{Incl. VAT}



Power rating: 60 W RMS
Available power:
60 W/20 W/15 W/10 W/5 W
8 Ohms/100 V
Tweeter: 1 inch
Woofer: 6.5 inch
Frequency response: 45 Hz - 20 kHz
Sensitivity (1 W @ 1 m): 89 dB
Attachment: swivel bracket
Humidity-resistant tropicalised speaker.
Dimensions: 340 x 220 x 200 mm
Net weight: 3.8 kg
Unit price - Sold by 2pcs

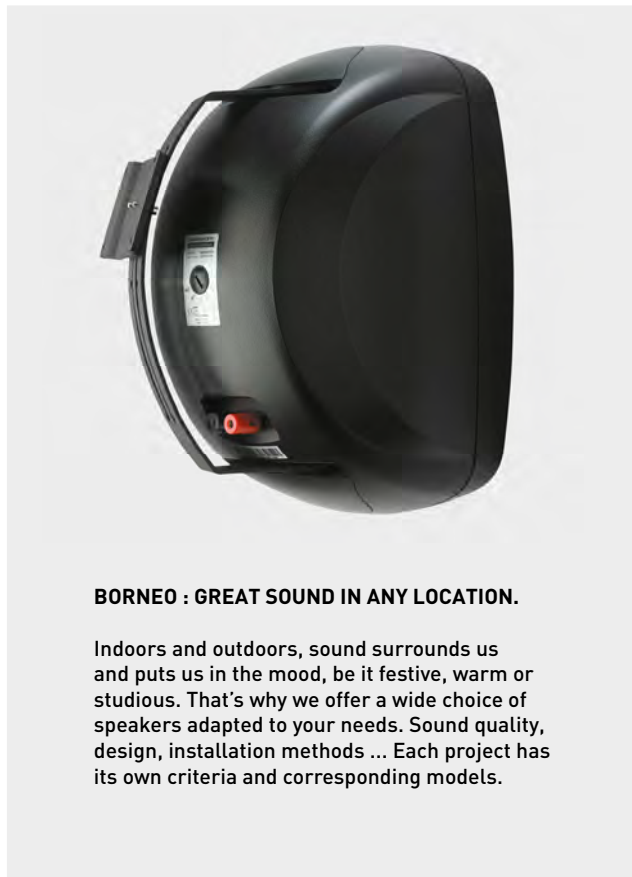

BORNEO : GREAT SOUND IN ANY LOCATION.

Indoors and outdoors, sound surrounds us and puts us in the mood, be it festive, warm or studious. That's why we offer a wide choice of speakers adapted to your needs. Sound quality, design, installation methods ... Each project has its own criteria and corresponding models.



EHP660IPb (1 pair)

Tropicalized speaker 6' 100V 7.5-60W/8 Ohms-black

Code : H10919

249€^{Incl. VAT}



Power outputs : 7,5 / 15 / 30 / 60 W
Voltage : 100 V 8 Ohms
Components : 6,5" + 1"
Sensitivity (1W/1m): 90 dB, +/-3dB
Frequency response : 70 - 20 000 Hz
Material : Plastic enclosure and aluminium grille
Holding : Wallmount bracket
Connectors : Waterproof cable on gland IP55
Power rotary knob : 60W 8Ω // 7,5 / 15 / 30 / 60 W 100V
Dimensions : 214x178 x 329 (H) mm
Weight : 4,7 Kg



EHP660IPw (1 pair)

Tropicalized speaker 6' 100V 7.5-60W/8 Ohms-white

Code : H10920

249€^{Incl. VAT}



Power outputs : 7,5 / 15 / 30 / 60 W
Voltage : 100 V 8 Ohms
Components : 6,5" + 1"
Sensitivity (1W/1m): 90 dB, +/-3dB
Frequency response : 70 - 20 000 Hz
Material : Plastic enclosure and aluminium grille
Holding : Wallmount bracket
Connectors : Waterproof cable on gland IP55
Power rotary knob : 60W 8Ω // 7,5 / 15 / 30 / 60 W 100V
Dimensions : 214x178 x 329 (H) mm
Weight : 4,7 Kg



EHP420IPb

Tropicalized speaker 4' 100V 2-20W/8 Ohms-black

Code : H10917

139€^{Incl. VAT}



Power outputs : 2,5 / 5 / 10 / 20 W
Voltage : 100 V 8 Ohms
Components : 4" + 1"
Sensitivity (1W/1m): 88 dB, +/-3dB
Frequency response : 90-18 000 Hz
Material : Plastic enclosure and aluminium grille
Holding : Lyre d'accroche murale
Connectors : Câble sur presse étoupe étanche IP55
Power rotary knob : 20W 8Ω // 2,5 / 5 / 10 / 20 W 100V
Dimensions : 158x129 x 238 (H) mm
Weight : 2,4 Kg



EHP420IPw

Tropicalized speaker 4' 100V 2-20W/8 Ohms-white

Code : H10918

139€^{Incl. VAT}



Power output: 2.5/5/10/20W
Power supply: 100V 8 ohms
Components: 4" + 1"
Sensitivity (1W/1m): 88dB, +/-3dB
Frequency response: 90 - 18,000Hz
Material: white ABS enclosure and metallic grille
Mounting: wall-mount yoke
Connectors: waterproof cable on gland IP55
Power selector: 20W 8Ω // 2.5/5/10/20W 100V
Dimensions: 158x129 x 238 (H) mm
Weight: 2.4kg

BROADCASTING



EHP880B

Installation speaker 80 Watts
2-way - 8 Ohms/70 V/100 V - Black

Code : H10212 149€^{Incl. VAT}



Power rating: 80 W RMS
Available power: 80 W/40 W/20 W at 100 V - 40 W/20 W/10 W at 70 V
80 W at 8 Ohms
Tweeter: 1"
Woofer: 8"
Frequency response: 70 Hz - 18 kHz
Sensitivity (1 W @ 1 m): 92 dB
Attachment: swivel bracket
Dimensions: 410 x 290 x 240 mm
Net weight: 8 kg
Unit price - Sold by 2pcs



EHP880W

Installation speaker 80 Watts
2-way - 8 Ohms/70 V/100 V - White

Code : H10213 149€^{Incl. VAT}



Power rating: 80 W RMS
Available power: 80 W/40 W/20 W at 100 V - 40 W/20 W/10 W at 70 V
80 W at 8 Ohms
Tweeter: 1"
Woofer: 8"
Frequency response: 70 Hz - 18 kHz
Sensitivity (1 W @ 1 m): 92 dB
Attachment: swivel bracket
Dimensions: 410 x 290 x 240 mm
Net weight: 8 kg
Unit price - Sold by 2pcs



EHP520b

Installation speaker 40 Watts
2-way - 8 Ohms/70 V/100 V - Black

Code : H9763 89€^{Incl. VAT}



Power rating: 40 W RMS
Available power: 40 W/20 W/10 W at 100 V - 20 W/10 W/5 W at 70 V
40 W at 8 Ohms
Tweeter: 1 inch
Woofer: 5 inch
Frequency response: 80 Hz - 18 kHz
Sensitivity (1 W @ 1 m): 89 dB
Attachment: swivel bracket
Dimensions: 270 x 187 x 165 mm
Net weight: 3.4 kg
Unit price - Sold by 2pcs



EHP520w

Installation speaker 40 Watts
2-way - 8 Ohms/70 V/100 V - White

Code : H9762 89€^{Incl. VAT}



Power rating: 40 W RMS
Available power: 40 W/20 W/10 W at 100 V - 20 W/10 W/5 W at 70 V
40 W at 8 Ohms
Tweeter: 1"
Woofer: 5"
Frequency response: 80 Hz - 18 kHz
Sensitivity (1 W @ 1 m): 89 dB
Attachment: swivel bracket
Dimensions: 270 x 187 x 165 mm
Net weight: 3.4 kg
Unit price - Sold by 2pcs



EHP410b

Installation speaker 20 Watts
2-way - 8 Ohms/70V/100V - Black

Code : H9761 79€^{Incl. VAT}



Power rating: 20 W RMS
Available power: 20 W/10 W/5 W at 100 V - 10 W/5 W/2.5 W at 70 V
20 W at 8 Ohms
Tweeter: 1"
Woofer: 4"
Frequency response: 80 Hz - 18 kHz
Sensitivity (1 W @ 1 m): 89 dB
Attachment: swivel bracket
Dimensions: 240 x 170 x 160 mm
Net weight: 1.45 kg
Unit price - Sold by 2pcs



EHP410w

Installation speaker 20 Watts
2-way - 8 Ohms/70 V/100 V - White

Code : H9760 79€^{Incl. VAT}



Power rating: 20 W RMS
Available power: 20 W/10 W/5 W at 100 V - 10 W/5 W/2.5 W at 70 V
20 W at 8 Ohms
Tweeter: 1"
Woofer: 4"
Frequency response: 80 Hz - 18 kHz
Sensitivity (1 W @ 1 m): 89 dB
Attachment: swivel bracket
Dimensions: 240 x 170 x 160 mm
Net weight: 1.45 kg
Unit price - Sold by 2pcs



ROT45b

Black swivel ball mount for speakers
EHP410b and EHP520b - 1 piece

Code : H9824 12€^{Incl. VAT}



ROT45w

White swivel ball mount for speakers
EHP410w and EHP520w - 1 piece

Code : H9825 12€^{Incl. VAT}



BROADCASTING



SpeakUP
Active lectern 40 W + MP3 / record + HF microphone

Code : H10830 549€^{Incl. VAT}



Amplified column lectern with VHF mic.
Built-in amplifier 40 W RMS.
Comes with 1 gooseneck microphone and 1 VHF hand-held microphone with in-built receiver.
1 MP3 reader/recorder module: USB/SD/MMC
1 XLR microphone input.
1 RCA auxiliary input.
3 full-range loudspeakers.
Frequency response: 100 Hz – 16 kHz
1 recording output or 0dB line (6.35 mm jack).
Power: 240 V 50/60 Hz
Dimensions: 1140 x 580 x 420 mm
Weight: 17.2 kg



Equipped with a USB/SD reader/recorder, the Speakup allows you to animate meetings and debates with its VHF microphone and to take advantage of digital media thanks to its USB charger.



OHO-350b (pair)
Spherical satellite speaker 50 W RMS
2-way - Black

Code : H10125 199€^{Incl. VAT}



Power rating: 50 W RMS
Frequency response: 100 Hz - 25 KHz
Sensitivity (1 W @ 1 m): 89 dB
Nominal impedance: 8 Ohms
Tweeter: 1 inch
Woofer: 3 inch
Connector: Terminal block integrated in the magneticbracke
Dimensions: 99 mm diameter
Weight: 0.7 kg
Price for the pair



OHO-350w (pair)
Spherical satellite speaker 50 W RMS
2-way - White

Code : H10124 199€^{Incl. VAT}



Power rating: 50 W RMS
Frequency response: 100 Hz - 25 KHz
Sensitivity (1 W @ 1 m): 89 dB
Nominal impedance: 8 Ohms
Tweeter: 1 inch
Woofer: 3 inch
Connector: Terminal block integrated in the magneticbracke
Dimensions: 99 mm diameter
Weight: 0.7 kg
Price for the pair



MIO-Sat225b (pair)
Wall speaker on adjustable mount, Hi-Fi speaker - 8 Ohms - 25 W

Code : H10150 55€^{Incl. VAT}



Power rating: 25 W RMS
Frequency response: 200 Hz - 15 KHz
Maximum SPL (@ 1 m): 110 dB
Nominal impedance: 8 Ohms
Speaker: 2 x 2.75 inches
Connector: Terminal block integrated in bracket
Dimensions: 90 x 136 x 180 mm
Weight: 0.950 kg
Price for the pair



TFS60
60W Transformer Input 7.5/15/30/60w in
100v out 80hms

Code : H10976 16€^{Incl. VAT}

TFS20
Transformer 20W Input 2.5/5/10/20w in
100v out 80hms

Code : H10975 10€^{Incl. VAT}

BROADCASTING



CHPsub

Ceiling recessed subwoofer
60 W / 8 Ohms - 60 W / 100 V

Code : H10533 219€^{Incl. VAT}



Power rating: 60 W RMS
Available power:
60 W at 8 Ohms
60 W / 40 W / 20 W at 100 V
Frequency response: 80 Hz - 200 Hz
Woofer: 8 inch
Sensitivity (1 W @ 1 m): 95 dB
Enclosed metal box
Integrated passive filter
External dimensions (diameter and depth):
295 x 215 mm
Drilling diameter: 265 mm
Net weight: 5 kg



CHF860

Hi-Fi ceiling recessed speaker 60 Watts
2-way - 8 Ohms

Code : H9909 139€^{Incl. VAT}



2-way speaker
Power rating: 60 W RMS
Impedance: 8 Ohms
Tweeter: 1 inch
Woofer: 6.5 inch
Frequency response: 40 Hz - 20 kHz
Sensitivity (1W/1m)
External dimensions (diameter and depth):
280 x 180 mm 90 dB
Drilling diameter: 247 mm
Net weight: 2.48 kg



CHF835

2-way ceiling light 35W 8inch 80hms
80hms

Code : H10965 69€^{Incl. VAT}



Power outputs : 35W RMS
Impedance: 8 Ohms
Components : 8" + 1"
Sensitivity (1W/1m): 86 dB, +/-3dB
Frequency response : 55-20 000 Hz
Material : white plastic enclosure and magnetic grille
Holding : 4 mouting clamp
Dimensions : 260(diam) x 100 (H) mm
Weight : 1,40 Kg

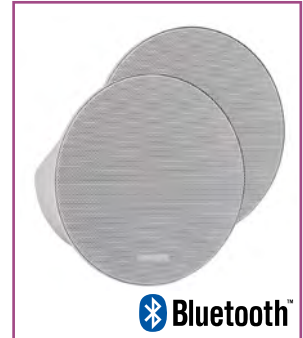

CHP6A-Bset

Ceiling lights 6.5 inches active 2x10w
BT 4.0

Code : H10933 139€^{Incl. VAT}



Power outputs : 10W
Impedance: 8 Ohms
Components : 6.5"
Sensitivity (1W/1m): 90 dB, +/-2dB
Frequency response : 110-15 000 Hz
Material : White plastic enclosure
Holding : 2 string grip
Connectors: Euro block
Bluetooth: 4.0
Dimensions : 190 mm (diam) x 105 mm
Weight : 1 Kg
Set of two ceiling speakers, one of which is active (with Bluetooth® receiver) and powers the other (passive).

HIGH-QUALITY VOICE AND MUSIC

The CHP835 ceiling speaker features a 2-way coaxial speaker producing a very pure sound even at low volume.

The tweeter is incredibly efficient at transmitting a clear vocal reproduction.



CHP660

Ceiling recessed speaker
2-way - 60 W / 8 Ohms - 10 W / 100 V

Code : H9910 119€^{Incl. VAT}



Power rating: 60 W RMS
Available power:
60 W at 8 Ohms
10 W / 5 W / 2.5 W / 1.25 W at 100 V
Tweeter: 1 inch
Woofer: 6.5 inch
Frequency response: 56 Hz - 20 kHz
Sensitivity (1 W @ 1 m): 90 dB
External dimensions (diameter and depth):
240 x 140 mm
Drilling diameter: 208 mm
Net weight: 1.75 kg



CHP630

Ceiling speaker 2-way 6" ABS white

Code : H10915 79€^{Incl. VAT}



Power: 30W
Available power: 100 V 8 Ohms
Components: 6.5" + 3/4"
Sensitivity (1W/1m): 89 dB, +/- 3dB
Frequency response: 90-20 000 Hz
Construction: White ABS body
Hook: 4 screwed tabs
Dimensions: 220 x 220 x 220 x 95 mm
Weight: 980 g



CHP630GB

Black ceiling grille for CHP630

Code : H10989 10€^{Incl. VAT}





CHP630SQ

Square ceiling speaker 2-way 6" ABS white

Code : H10974 49€^{Incl. VAT}



Power: 30W RMS
Available power: 100 V 8 Ohms
Components: 5" + 0.5" + 0.5"
Sensitivity (1W/1m): 89 dB, +/- 3dB
Frequency response: 90-20 000 Hz
Construction: White ABS body
Hook: 4 screwed tabs
Dimensions: 220 x 220 x 220 x 95 mm
Weight: 980 g



CHP620

Ceiling recessed speaker
2-way 20 W / 100 V

Code : H9757 59€^{Incl. VAT}



Power rating: 20 W RMS
Available power:
20 W / 10 W at 100 V
Tweeter: 1.5 inch
Woofer: 6.5 inch
Frequency response: 85 Hz - 18 kHz
Sensitivity (1 W @ 1 m): 98 dB
External dimensions (diameter and depth):
233 x 118 mm
Drilling diameter: 200 mm
Net weight: 1.7 kg



CHP610

Ceiling recessed speaker
2-way 10 W / 100 V

Code : H9756 49€^{Incl. VAT}



Power rating: 10 W RMS
Available power:
10 W / 5 W / 2.5 W at 100 V
Tweeter: 1.5 inch
Woofer: 6.5 inch
Frequency response: 56 Hz - 20 kHz
Sensitivity (1 W @ 1 m): 93 dB
External dimensions (diameter and depth):
230 x 90 mm
Drilling diameter: 200 mm
Net weight: 1.4 kg



CHP606

Ceiling recessed double cone speaker
6 W / 100 V

Code : H9755 25€^{Incl. VAT}



Power rating: 6 W RMS
Available power:
6 W / 3 W at 100 V
Speaker: double cone 6.5 inches
Frequency response: 110 Hz - 13 kHz
Sensitivity (1 W @ 1 m): 90 dB
External dimensions (diameter and depth):
230 x 90 mm
Drilling diameter: 200 mm
Net weight: 0.9 kg



CHP520SQ

2-way square ceiling speaker 5" ABS white
100V 5/10/20W

Code : H10916 39€^{Incl. VAT}



Power outputs: 5 / 10 / 20 W
Voltage: 100 V / 8 ohms
Components: 4" + 1/2"
Sensitivity (1W/1m): 89 dB, +/-3dB
Frequency response: 90-18 000 Hz
Material: White plastic enclosure and metallic grille
Holding: 4 mouting clamp
Connectors: 4 contacts connector
Drill hole dimensions: 156 x 156 mm
Dimensions: 190 x 190 x 80 (H) mm
Weight: 1,3 Kg



CHP520

2-way ceiling speaker 5" 100V 5/10/20W

Code : H10914 69€^{Incl. VAT}



Power outputs: 5 / 10 / 20 W
Voltage: 100 V / 8 ohms
Components: 5" + 3/4"
Sensitivity (1W/1m): 88 dB, +/-3dB
Frequency response: 100-20 000 Hz
Material: Black plastic enclosure and white magnetic grille
Holding: 3 mouting clamp
Connectors: 4 contacts connector
Drill hole diameter: 180mm
Dimensions: 203(diam) x 85 (H) mm
Weight: 1.5 Kg



CHP520GB

Black ceiling grille for CHP520

Code : H10988 9€^{Incl. VAT}



CHP506

Ceiling speaker 5" double speaker cone
ABS white 100V 3/6W

Code : H10912 19€^{Incl. VAT}



Power outputs: 3 / 6 W
Voltage: 100 V
Components 5" loud-speaker
Sensitivity (1W/1m): 93 dB, +/-3dB
Frequency response: 100-15 000 Hz
Material: Metallic grille and plastic enclosure
Holding: 2 string grip
Connectors: 3 contacts connector
Drill hole diameter: 145mm
Dimensions: 160(diam) x 54 (H) mm
Weight: 500 g

BROADCASTING



SHP510

Suspended aluminium speaker IP55
10 W / 100 V

Code : H9758

69€^{Incl. VAT}



Power rating: 10 W RMS
Available power:
10 W / 5 W / 2.5 W at 100 V
Frequency response: 150 Hz – 15 kHz
Speaker: 5 inch
Sensitivity (1 W @ 1 m): 90 dB
White aluminium body,
Ingress protection: IP55 (weather-resistant)
Dimensions (Ø x D): 138 x 205 mm
Weight: 2.2 kg



SHP820w

Suspended 2-way 8" diff. 360°-100V 5-20W

Code : H10925

119€^{Incl. VAT}



Power outputs : 5 / 10 / 20 W
Voltage : 100 V
Components : 8" + 1"
Sensitivity (1W/1m): 88 dB, +/-3dB
Frequency response : 130-15 000 Hz
Material : White plastic enclosure
Holding : 5 m slung cable
Connectors : Cable on gland
Dimensions : 254 mm (diam)
Weight : 2,2 kg



PHP510

Aluminium sound projector IP55
10 W / 100 V

Code : H9759

69€^{Incl. VAT}



Power rating: 10 W RMS
Available power:
10 W / 5 W / 2.5 W at 100 V
Frequency response: 150 Hz – 14 kHz
Speaker: 5 inch
Sensitivity (1 W @ 1 m): 90 dB
White aluminium body,
Ingress protection: IP55 (weather-resistant)
Dimensions (Ø x D): 138 x 205 mm
Weight: 2.1 kg



PHP650

Sound projector IP55
50 W / 100 V

Code : H10211

219€^{Incl. VAT}



Power rating: 50 W RMS
Available power:
50 W/25/12.5/9/4.5/2.6 at 100 V
Frequency response: 90 Hz – 20 kHz
Speaker: 6.5 inches and 1-inch
compression
Sensitivity (1 W @ 1 m): 99 dB
ABS body,
Ingress protection: IP55 (weather-resistant)
Dimensions: 363 x 253 x 310 mm
Weight: 3.9 kg



INTERIOR / EXTERIOR

High power and wide roof to cover a large area. The PHP650 sound projector offers a very good reproduction of voice and music. Robust and weatherproof.

BROADCASTING

The columns are delivered with wall mounting brackets.

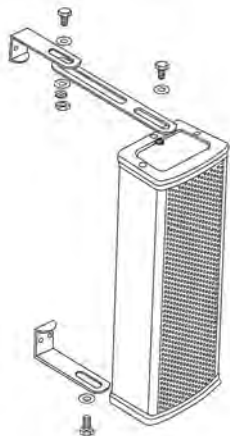

Aluminium speakers are designed to resist humidity. The wiring is mounted on a cable gland to ensure the waterproofing.

The multi-speaker system columns allows a diffusion very wide while reducing the vertical angle. This prevents echoes. The column is therefore the ideal tool for speeches in big spaces.



CLS220
2-speakers column
100 V - 10/20 W

Code : H10514 69€^{Incl. VAT}



Power rating: 20 W RMS
Available power:
20 W / 10 W at 100 V
Speaker: 2 x 2.5 inches
Frequency response: 250 Hz -15 KHz
Sensitivity (1 W @ 1 m): 94 dB
Aluminium body and grill,
Ingress protection: IP44 (weather-resistant)
Dimensions: 104 x 73 x 262 mm
Weight: 1.4 kg



CLS440
4-speakers column
100 V - 20/40 W

Code : H10515 79€^{Incl. VAT}



Power rating: 40 W RMS
Available power:
40 W / 20 W at 100 V
Speaker: 4 x 2.5 inches
Frequency response: 250 Hz -15 KHz
Sensitivity (1 W @ 1 m): 95 dB
Aluminium body and grill,
Ingress protection: IP44 (weather-resistant)
Dimensions: 104 x 73 x 402 mm
Weight: 1.94 kg



CLS660
6-speakers column
100 V - 30/60 W

Code : H10516 99€^{Incl. VAT}



Power rating: 60 W RMS
Available power:
60 W / 30 W at 100 V
Speaker: 6 x 2.5 inches
Frequency response: 250 Hz -15 KHz
Sensitivity (1 W @ 1 m): 96 dB
Aluminium body and grill,
Ingress protection: IP44 (weather-resistant)
Dimensions: 104 x 73 x 550 mm
Weight: 2.6 kg



CLS880
8-speakers column
100 V - 40/80 W

Code : H10517 119€^{Incl. VAT}



Power rating: 80 W RMS
Available power:
80 W / 40 W at 100 V
Speaker: 8 x 2.5 inches
Frequency response: 250 Hz -15 KHz
Sensitivity (1 W @ 1 m): 97 dB
Aluminium body and grill,
Ingress protection: IP44 (weather-resistant)
Dimensions: 104 x 73 x 690 mm
Weight: 3.34 kg

AMPLIFIERS



★★★★★



★★★★★



AMP120

Amplifier 120W – 8 Ohms/70/100 V

Code : H9903

379€^{Incl. VAT}



RMS power: 120 W
 Output levels / Impedance:
 - 100 V [83 Ohms]
 - 70 V [42 Ohms]
 - 4 Ohms [21.9 V]
 Balanced XLR input/output
 Power output on Phoenix plug
 Frequency response: 70 Hz – 18 KHz
 T.H.D (1 KHz): <1%
 400 Hz High-pass filter
 Power supply: 230 V 50/60 Hz
 - DC24V (safe power)
 Dimensions: 482 x 88 x 330 mm
 19-inch rackable, Height: 2 units
 Net weight: 11.6 Kg

AMP240

Amplifier 240 W – 8 Ohms/70/100 V

Code : H9904

479€^{Incl. VAT}



RMS power: 240 W
 Output levels / Impedance:
 - 100 V [42 Ohms]
 - 70 V [21 Ohms]
 - 4 Ohms [31 V]
 Balanced XLR input/output
 Power output on Phoenix plug
 Frequency response: 70 Hz – 18 KHz
 T.H.D (1 KHz): <1%
 400 Hz High-pass filter
 Power supply: 230 V 50/60 Hz
 - DC24V (safe power)
 Dimensions: 482 x 88 x 330 mm
 19-inch rackable, Height: 2 units
 Net weight: 13.8 Kg



★★★★★



★★★★★



AMP480

1-way amplifier
 1 x 480 W at 100 V

Code : H10512

549€^{Incl. VAT}



1 mono input via Phoenix plug
 1 100V output via Phoenix plug
 1 line level link output via Phoenix plug
 Channel volume adjustment
 Flat/HPF channel switch
 Output level display via 4 LED VU meters
 Access to installer settings (via screwdriver)
 Power supply: 230 V 50/60 Hz
 Frequency response: 50 Hz - 15 kHz
 T.H.D (1 kHz nominal power): 0.1%
 Dimensions: 380 x 088 x 482 mm
 19-inch rackable, Height: 2 units
 Weight: 6.6 kg



REG60

Remote volume adjuster in wall box – 60 W

Code : H9753

25€^{Incl. VAT}



Power: 60 W / 100 V
 24 V Priority input
 Settings: Off/-17 dB/-11 dB/-4.5 dB/0 dB
 Frequency response: 20 Hz - 20 kHz
 White ABS body
 Fixing: REG-BOX (optional)
 Connection: 6-pin connector
 (IN+ IN- / OUT+ OUT- / 0 V 24 V)
 Dimensions: 86 x 86 x 70 mm
 Weight: 0.250 kg.



REG-BOX

Recessed box for wall adjuster REG60

Code : H9754

2€^{Incl. VAT}



AMPLIFIERS



NEW



AMP4120MKII 4-way amplifier 4 x 120 W at 100 V	AMP4240MKII 4-way amplifier 4 x 240 W at 100 V
Code : H11070 599€ ^{incl. VAT}	Code : H11071 699€ ^{incl. VAT}
	

4 mono inputs via Phoenix plug
 4 100 V outputs via Phoenix plug
 4 line level link outputs via Phoenix plug
 Volume adjustment for each channel,
 Flat/HPF switch for each channel
 Output level display for each channel via
 4 LED VU meters
 Access to installer settings
 Power supply: 230 V 50/60 Hz
 Frequency response: 50 Hz - 15 kHz
 T.H.D (1 kHz nominal power): 0.1%
 Dimensions: 390 x 088 x 482 mm
 19-inch rackable, Height: 2 units
 Weight: 7.2kg

4 mono inputs via Phoenix plug
 4 100 V outputs via Phoenix plug
 4 line level link outputs via Phoenix plug
 Volume adjustment for each channel,
 Flat/HPF switch for each channel
 Output level display for each channel via
 4 LED VU meters
 Access to installer settings
 Power supply: 230 V 50/60 Hz
 Frequency response: 50 Hz - 15 kHz
 T.H.D (1 kHz nominal power): 0.1%
 Dimensions: 390 x 088 x 482 mm
 19-inch rackable, Height: 2 units
 Weight: 7.5 kg

4-CHANNEL PROFESSIONAL AMPLIFIER

- + Compact and lightweight design
- + Technician settings at the rear

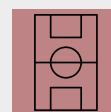

WIDE-OPEN SPACES



IN THE SHOP



AMPLIFIERS

WICASTamp is an amplified audio transmitter capable of transforming your passive speakers into a multi-room sound system thanks to your WI-FI network.

Great sound in every room

For multi-room use, you must have one WICASTamp per room with one passive speaker (or a pair of passive speakers).

Send sound from streaming services from your computer or your phone.

The MUZO PLAYER application allows you to control everything.



NEW



WICASTPLAY

Multiroom audio system

Code : H10996 89€Incl. VAT



NEW



WICASTAMP

Amplified multi-room audio system

Code : H10995 119€Incl. VAT



1x mini-jack output 3.5 mm analog
Powered by a 5 V Micro USB connector
300mA of consumption only
Compatible with AirPlay and major streaming service
USB & SD drive
Alarm clock function
Programmed stop function

Impedance 8 Ohms
2 x 15 W RMS (amplification included)
1x mini-jack input 3.5 mm analog
External powered 15 V DC - 2 A
Compatible with AirPlay and major streaming services
USB and SD drive
Alarm clock function
Programmed stop function

COMPATIBLE WITH MUSIC STREAMING SERVICE

TIDAL

Spotify

napster

qobuz

AMPLIFIERS



Bluetooth™

WALLAMPtouch

Touch screen 2x10W touch screen SD/BT/ Radio/AUX

Code : H10931 299€^{Incl. VAT}



Power ratings: 2x10W
Impedance: 8 Ohms
Power supply: 240 V
Frequency response: 20 - 20 000 kHz
Output: Line output for external amplifier
Port: SD, USB
Audio format: MP3, WMA, WAV, AAC, FLAC
Infrared remote control
Bluetooth®: 4.1
Dimensions: 86 x 86 x 86 x 38 mm



Bluetooth™

WALLAMPpad

Touch screen 2x20W tactile SD/BT/AUX/ DLNA/Airplay&App

Code : H10932 499€^{Incl. VAT}



Power : 2X20W
Impedance: 8 Ohms
240V power supplies
Frequency response: 20 - 20 000 Hz
Aux output for an external amplifier
Port: SD/ RJ45
Sources: Bluetooth® 4.0 / DLNA / Airplay / WiFi / Webradio / Network music / Application / Aux in
Dimensions: 172 x 86 x 45 mm



Bluetooth™

WALLKIT

WALLAMPmedia + ceiling lights set

Code : H10964 169€^{Incl. VAT}



Wall amplifier set
WALLAMPmedia 2 x 10W with 2x 2-way ceiling speakers
240V power supply
Frequency response: 20 - 20 000 Hz
Impedance: 8 Ohms
Components: 6.5" + 0.75" + 6.5
Sensitivity. (1W/1m) : 103 dB, +/-2dB
Frequency response: 90-18 000 Hz
Construction: Black ABS body and white magnetic metal grid
Hook: 2 legs. spring
Dimensions: 190 mm (diameter) x 105 mm
Weight: 1 Kg



Bluetooth™

WALLAMPmedia

Wall amplifier 2x10W USB/SD/BT/Radio/ AUX

Code : H10930 149€^{Incl. VAT}



Power outputs: 2x10W
Impedance: 8 Ohms
Power supply: 240 V
Signal-to-noise ratio: 81 dB →81 dB
Output: Line output for external amplifier
Memory card capacity: 128 MB - 32GB
Audio format: MP3, WMA, WAV, AAC, FLAC
Bluetooth: 2.1+EDR
Dimensions: 86 x 86 x 86 x 38 mm
Infrared remote control

Bluetooth™



SIMPLE AND INTUITIVE MUSICAL CONTROL

Broadcast music with just a few taps. Play a song from any audio source through the USB/SD/BT/FM/AUX. Thanks to its line output for an external amplifier, you can broadcast music in several rooms.



Flush-mounted box compatible with WALLAMPtouch and WALLAMPmedia

H10637 - PILOTBOX - Square back box 47 mm steel
H10638 - PILOTSCREW - Steel screw size M3.5x20 - 1 piece



AMPLIFIERS



COMBO240

Multi-zone combined mixer amplifier line
100V combo 5 zones 6 inputs - 240W

Code : H9751

499€^{incl. VAT}



All-in-one 240W system with multimedia option
6-input mixer
5 independent simultaneous zones
7-band graphic equalizer
Paging, siren and chime control
Priority mode and Phantom power on channels 1 and 2
5-pin DIN input microphone
XLR line or microphone input on channels 2 to 5
RCA input on channel 6
Paging input on Phoenix plug
AMP IN and PRE-AMP OUT connections
LINK IN and LINK OUT connections
100 V / 8 to 4 Ohms outputs on the terminal block
Dimensions: 420 x 320 x 88 mm
19-inch rackable
Weight: 10.8 kg

Optional:

MOD1

USB/SD reader module and AM/FM
Tuner receiver for COMBO240

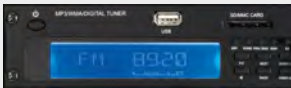

MOD1

USB/SD reader module and AM/FM Tuner
receiver for COMBO240

Code : H9752

199€^{incl. VAT}



Tuner receiver: AM / FM
Autoscan, Manual scan
FM frequencies: 87.5 MHz - 108 MHz
AM frequencies: 522 kHz - 1620 kHz
USB reader: mp3 files
Functions: read, search, programming
Recognition of more than 2000 files and
200 folders.
Equalisation: Classic / Pop / Jazz / Rock
with the LOUD function
Technical characteristics:
Signal-to-noise ratio: Less than 70 dB
Frequency response: 20 Hz - 20 kHz
THD: Less than 0.1%
Maximum consumption: 500 mA



- All-in-one system with multimedia option
- 6-input mixer
- 5 Switchable zones
- 7-band graphic equaliser
- Paging and chime control
- 19-inch rackable
- Removable brackets



★★★★★



★★★★★



MIC-DESK

Announcement microphone fitted with
'push to talk' system

Code : H9748

79€^{incl. VAT}



Dynamic capsule
Frequency response: 40 Hz to 16 kHz
Sensitivity: -43 dB
Impedance: 200 Ohms
Comes with:
1 XLR 5-pin female / DIN 5-pin male
5 m cable.
1 XLR 5-pin female / 6.35 mm mono
Jack male 3 m cable.
Dimensions: 430 x 200 x 75 mm
Weight: 1.05 kg

AMPLIFIERS



COMBO60

Multimedia combined mixer/amplifier/reader line 100V 60W Tuner and USB reader

Code : H9749

329€ incl. VAT



60W compact all-in-one system
 3-input mixer:
 2-way microphone - Aux1/MP3/TUNER
 Low, mid and high settings
 Mp3 and Tuner player controls
 Output level VU meter
 6.35 input jack for microphones
 AUX input and CD on RCA
 Waiting music input on Phoenix plug
 Paging input on Phoenix plug
 Connections for FM and AM antennas
 100 V / 16 / 8 / 4 Ohms outputs on the terminal block
 Tuner receiver: AM / FM
 Autoscan, Manual scan
 FM frequencies: 87,5 MHz - 108 MHz
 AM frequencies: 522 kHz - 1620 kHz
 USB reader: mp3 files
 Functions: read, search, programming time setting
 Power: 220 V 50-60 Hz
 Consumption: 175 W
 Dimensions: 90 x 270 x 260 mm
 Net weight: 5 kg



- Compact all-in-one system
- Integrated USB reader and tuner
- Microphone input and 2 line inputs
- Paging and waiting music compatible
- Priority safety output
- 3-band equalizer



COMBO130

Multimedia combined mixer/amplifier/reader line 200V 130W Tuner and USB reader

Code : H9750

399€ incl. VAT



130W all-in-one system
 5-input mixer:
 3-way microphone - Aux1/MP3/TUNER - Aux2
 Low and high settings
 Mp3 and Tuner player controls
 Chime activation
 Output level VU meter
 6.35 input jack for microphones 1 and 2
 RCA input for AUX1 and AUX2
 OUT output on RCA
 Connections for FM and AM antennas
 100 V / 16 to 4 Ohms outputs on the terminal block
 Tuner receiver: AM / FM
 Autoscan, Manual scan
 FM frequencies: 87,5 MHz - 108 MHz
 AM frequencies: 522 kHz - 1620 kHz
 USB reader: mp3 files
 Functions: read, search, programming time setting
 Power: 220 V 50-60 Hz
 Consumption: 175 W
 Dimensions: 483 x 89 x 366 mm
 Net weight: 11.36 kg



- All-in-one system
- 5-input mixer
- Push-button chimer
- 19-inch rackable
- 70 V/100 V amplified output or low impedance
- 1 front-panel microphone input



AMPLIFIERS

MULTI-ZONE MIXER/AMPLIFIER BY EXCELLENCE

Resolutely focused on professional installations, the ZONEAMP4120 system offers 4 mono mic/line inputs and 4 stereo inputs. Each input can be independently routed to the zone of your choice. Compatible with WP1 wall controller and MIC-DESK4 desk.



ZONEAMP4120

8 channels and 4 120W outputs at 100V
Amplified mixer

Code : H10513

849€^{incl. VAT}



- 4 Mic/Line inputs on XLR/6.35 Jack (TRS)
- 4 stereo inputs on RCA or 6.35 Mono Jack
- 4 link out outputs per zone on Phoenix plug
- 4 120W at 100V outputs on Phoenix plug
- Microphone priority on input 1
- Phantom power on inputs 1 to 4
- Gain and tone control (3 bands) on channels 1 to 4
- Gain control on all inputs
- Tone control (2 bands) per zone
- 5 RJ45 connectors to connect 1x WP-1 per zone and to connect 1x MIC-DESK4
- General Mute key
- Zone allocation 1 to 4 on each input
- Signal / Peak display on each input
- 5 LED VU meters per zone
- AFL / PFL front panel HP monitoring
- Power supply: 230 V 50/60 Hz
- Frequency response: 20 Hz - 20 kHz
- Dimensions: 320 x 088 x 482 mm
- 19-inch rackable, Height: 2 units
- Weight: 9 kg



8 INPUTS

Each input can be routed to your chosen zone or zones.
Installer settings are accessible with a screwdriver.



4 OUTPUTS

The ZONEAMP4120 is equipped with a monitoring loudspeaker to verify the signal sent to each output.

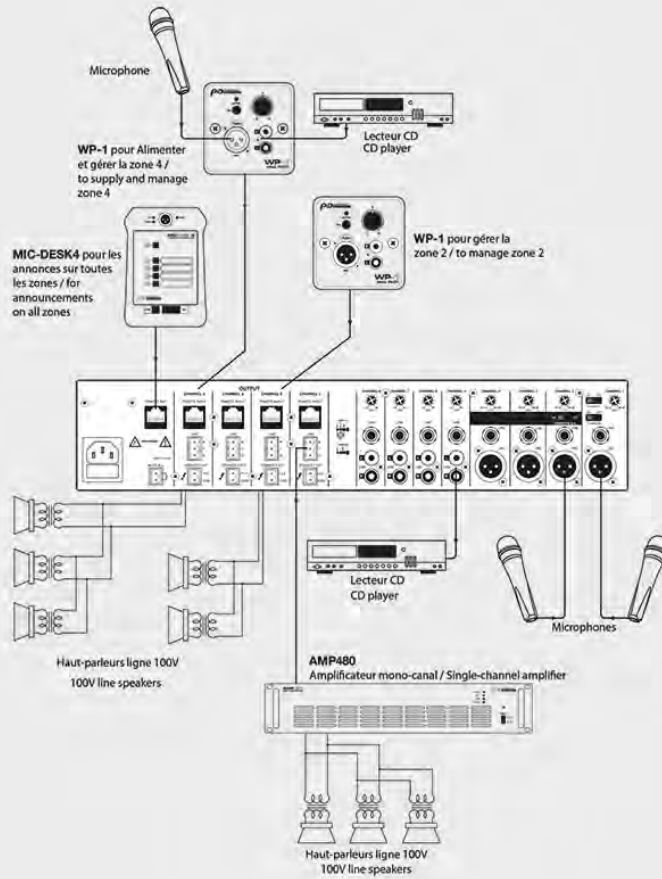

RJMF10

RJ45 M/F cable 10cm

Code : H10929

6€^{Incl. VAT}



WP-1

Wall-mounted controller for ZONEAMP4120 or PREZONE444

Code : H10508

29€^{Incl. VAT}



MIC-DESK4

Microphone for ZONEAMP4120, PREZONE444, MX82, MX44 et PMX34

Code : H10509

149€^{Incl. VAT}



1 front panel XLR microphone input
 1 front panel RCA line input
 1 back panel RJ45 connection
 Front panel volume control
 ON/OFF Switch
 Source display shown by LED
 DC15V power by RJ45 cable from the ZONEAMP4120 or the PREZONE444
 Dimensions: 80 x 80 x 50 mm
 Weight: 0.2kg

1 front panel XLR microphone input
 1 rear RJ45 output
 Talk switch on front panel to enable microphone
 Chime switch to launch chime
 Zone selection switch
 Volume setting (Microphone and Chime)
 Lock/unlock switch to block zone selection
 LED level display
 Power by RJ45 cable from the ZONEAMP4120 or the PREZONE444
 Frequency response: 45 Hz - 15 kHz
 T.H.D (1 kHz nominal power): < 0.1%
 Dimensions: 140 x 60 x 205 mm
 Weight: 0.9kg

MIXERS

MX44



PMX34



NEW



MX44
Mixer 4 inputs / 4 outputs

Code : H11018 469€incl. VAT



NEW



PMX34
Mixer 2IN + 1 USB/SD/TUNER/BT
Multimedia Player - 4OUT 1U matrixable

Code : H11017 449€incl. VAT



2 balanced inputs Microphone/line mono or stereo on Euroblocks connectors
2 mono or stereo line inputs on Euroblock connectors
4 balanced mono or stereo outputs on Euroblocks connectors
Priority microphone
Phantom power supply on inputs 1 and 2
Gain and tone adjustment (3 bands) on channels 1 and 2
Gain adjustment on all inputs
RJ45 connector for microphone control panel
Mute contact possible on outputs 1 to 4
Assignment of zones 1 to 4 on each input channel
Signal and Peak display on each input channel
Output level display by zone via 3 LEDs
Vu meter
Power supply 110-240v AC or 24v DC

2 balanced Mic/Line inputs on Euroblocks connectors
USB/SDz/BT/BT/Tuner media player/recorder
4 balanced mono or stereo outputs on Euroblocks connectors
Priority microphone
Phantom power supply on inputs 1 and 2
Gain and tone adjustment (3 bands) on channels 1 and 2
Gain adjustment on all inputs
RJ45 connector for microphone control panel
Mute contact possible on outputs 1 to 4
Assignment of zones 1 to 4 on each input channel
Signal and Peak display on each input channel
Output level display by zone via 3 LEDs
Vu meter
Power supply 110-240v AC or 24v DC

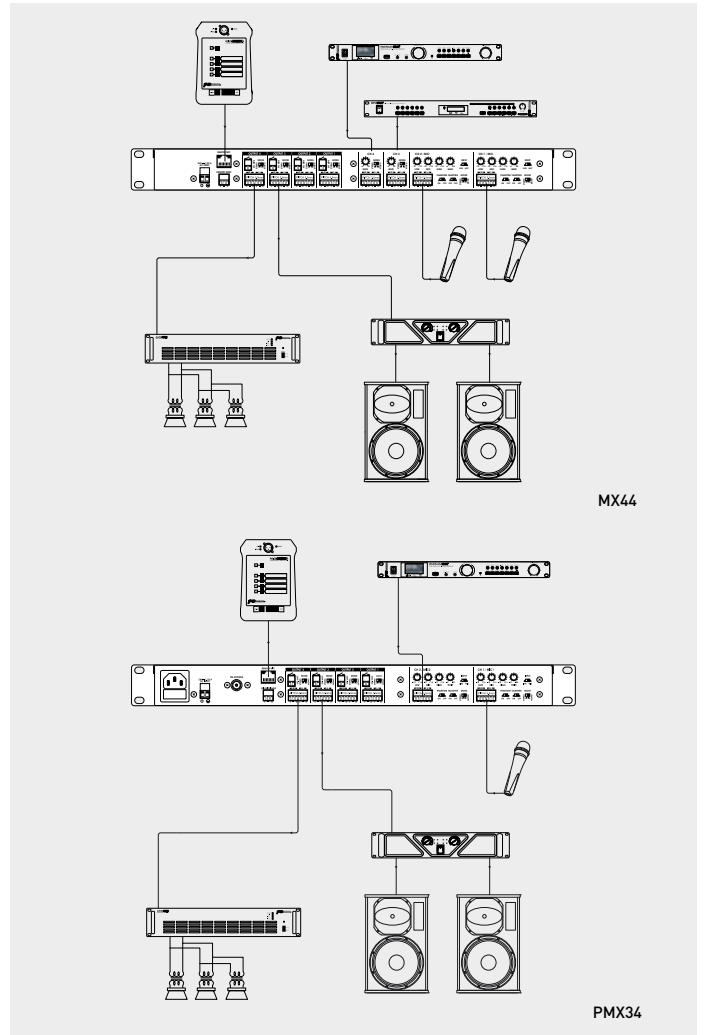

MIXERS

COMPATIBLE WITH MIC-DESK4

Resolutely focused on professional installations, the MIX82 mixer/preamp offers 2 mono mic/line inputs and 6 stereo inputs. Each input can be independently routed to one of two zones, or both zones simultaneously, to offer a maximum range of options.





MX82
1U 8IN 2OUT stereo mixer with priority + Remote Mic

Code : H10926 379€^{incl. VAT}



Rated output Level/impedance : 0 dB / 600 Ohms balanced
 Input sensivity / Impedance:
 Mic input (CH1-2) - 60 dB - 16dB / 20 Ohms balanced
 Line input (CH1-6) - 60 dB - + 4dB / 20 Ohms balanced
 Frequency Response [-1 dB]: 20 Hz - 20 000 Hz
 T.H.D: < 0,1%
 Crosstalk: → 70 dB
 Equalization :
 Mic input : High: 12 kHz ± 15 dB / Mid : 2,5 kHz ± 15 dB / Low : 80 Hz ± 15 dB
 Output:
 High: 10 kHz ± 15 dB / Low : 100 Hz ± 15 dB
 Hum & Noise: → 90 dB
 Weight: 9 kg
 Dimensions: 482 x 44 x 320 mm
 Power supply 110-240v AC ac or 24v DC



8 INPUTS

Each input can be routed to your chosen zone or zones. Installer settings are accessible with a screwdriver.

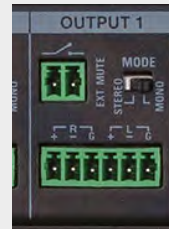

2 OUTPUTS

The MX82 has 2 outputs equipped with a 2-band equalizer and independent level adjustment.

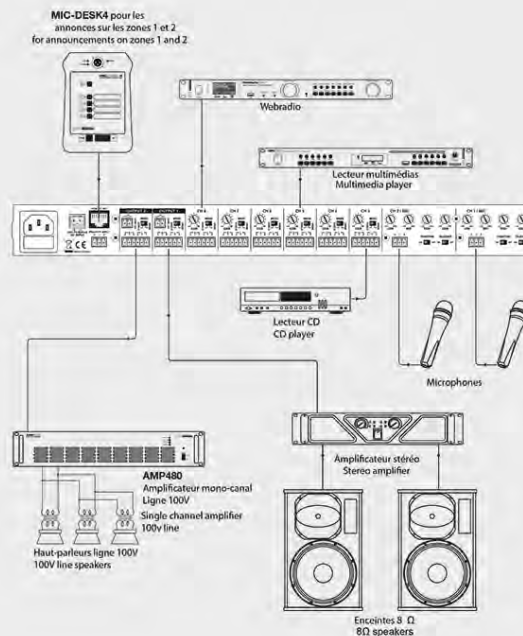

MIXERS



COMPATIBLE WP1 AND MIC-DESK4

The WP1 enables remote input from another room and to control the volume in that zone.

The MIC-DESK4 enables announcements to be made in selected zones.



PREZONE444

8 channels and 4 independent output zones mixer

Code : H10507

499€ Incl. VAT



- 4 Mic/Line inputs on XLR/6.35 Jack (TRS)
- 4 stereo inputs on RCA or 6.35 Mono Jack
- 4 line outputs per zone on Phoenix plug
- Microphone priority on input 1
- Phantom power on inputs 1 to 4
- Gain and tone (3 bands) on input 1 to 4
- Gain control on all inputs
- Tone control (2 bands) per zone
- 5 RJ45 connectors to connect 1x WP-1 per zone and to connect 1x MIC-DESK4
- General Mute key
- Zone allocation 1 to 4 on each input
- Signal / Peak display on each input
- 5 LED VU meters per zone
- AFL / PFL front panel HP monitoring
- Power supply: 230 V 50/60 Hz DC 24V
- Dimensions: 320 x 088 x 482 mm
- 19-inch rackable, Height: 2 units Weight: 5 kg

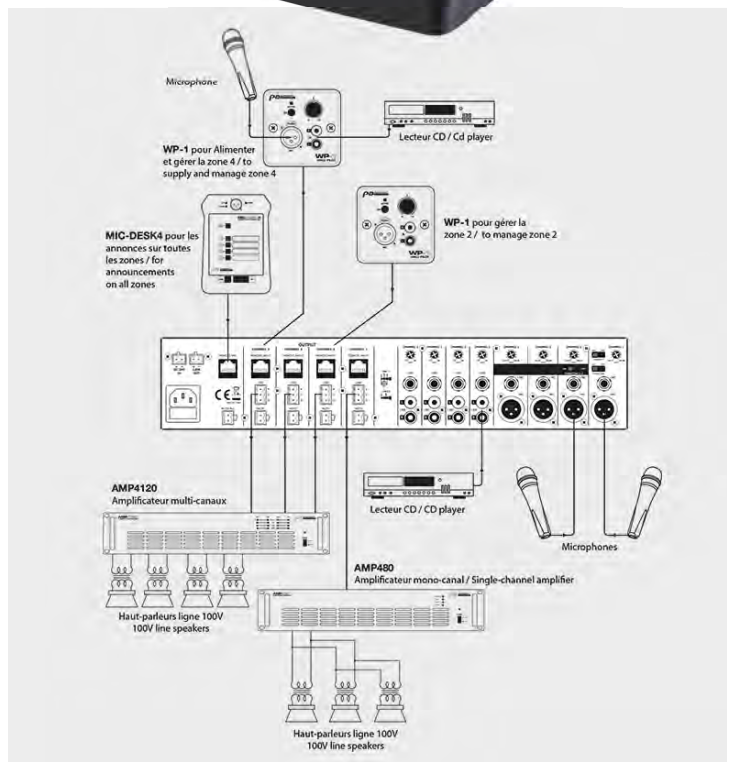

MIXERS

THE IDEAL COMPACT MIXER/ZONER TO USE WITH MULTIPLE SOURCES

Resolutely focused on professional installations, the PREZONE642 mixer-preamp offers 6 mono mic/line inputs via XLR or jack and 4 stereo inputs via RCA or jack.

MICROPHONE AND LINE INPUT

EACH MICROPHONE INPUT HAS:

- Gain setting
- 3-band equalizer
- These settings are reserved for installation and can only be modified by means of a screwdriver

EACH LINE INPUT HAS:

- Gain setting. (This setting is reserved for installation and can only be modified by means of a screwdriver)

AN ADVANCED MASTER SECTION

EACH ZONE HAS:

- Its own volume
- Its own equalisation
- Its own SUB output level setting
- Its own output level display

THE HEADPHONE SECTION IS ADVANCED WITH:

- Listening selection per channel via a PFL switch per increment
- The possibility to listen to each output independently via a zone selector.



PREZONE642

Mixer 10 inputs/Preamp 2 zones 6 microphone inputs - 4 line inputs - 2 zones

Code : H9902

399€^{Incl. VAT}



★★★★★



★★★★★

6 Mic/Line inputs on XLR/6.35 Jack CH1 and 2 phantom power and priority microphone

4 stereo inputs on RCA or Jack
Zones 1 and 2 balanced outputs on XLR
Balanced SUB output per zone on Jack
Stereo REC Output output on RCA
Gain and tone (3 bands) on inputs 1 to 6
Gain setting on stereo inputs
Tone control (2 bands) per zone
SUB volume per zone setting
Zone allocation and PFL per input
LED signal and Peak display
8 LED VU meters per zone
Headphone output with volume (zones and PFL)

Power supply: 230 V 50/60 Hz DC24V

Dimensions: 295 x 085 x 482 mm

19-inch rackable, Height: 2 units

Weight: 5 kg

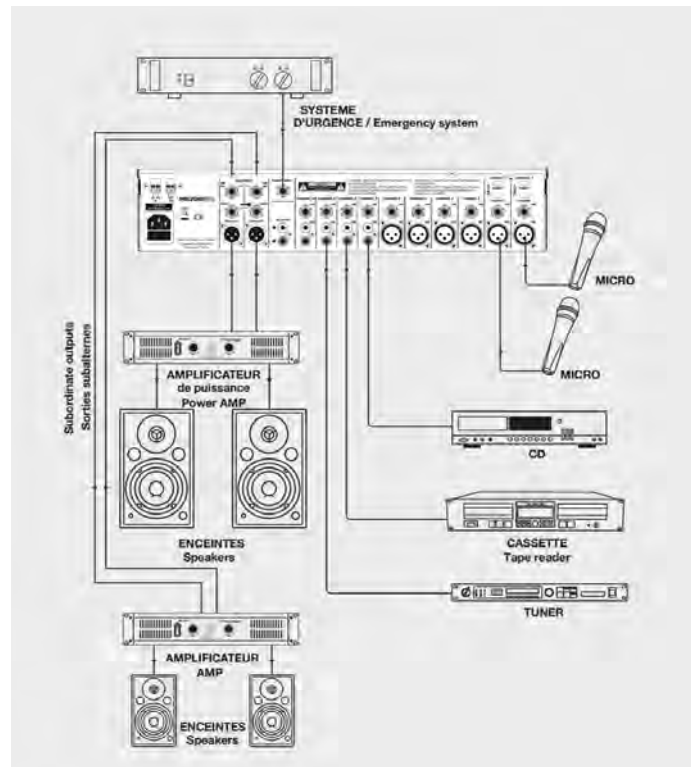

ANALOG MATRIX



PREZONE88

Analog matrix 8 inputs 8 outputs 8 outputs

Code : H10927

1199€^{Incl. VAT}



- 8 inputs and 8 outputs can be matrixed
- 4 MIC-DESK microphone console ports
- One telepaging microphone input with phantom power
- Possibility to remote one wall controller per zone (WS8 or WP8)
- DRP (Digital Recording and Playback) up to 60 seconds
- Output extension for the use of several PREZONE88 up to 4 units, i.e. 32 zones
- Priority: PAGING → DRP → MRM → MWP8A → BGM
- 8 BGM input indicators (-20dB)
- Easy installation with CAT-5 cable
- 2-band EQ per output (100Hz/10kHz)
- Balanced outputs on Phoenix terminal block
- Power supply 110-240v AC or 24v DC



MIC-DESK16M

16-zone micro console for PREZONE88

Code : H10978

229€^{Incl. VAT}



MIC-DESK8M

8-zone micro console for PREZONE88

Code : H10977

219€^{Incl. VAT}



WP8

Wall-mounted controller for PREZONE88
Source, volume, MIC input and line input selector switch

Code : H10928

79€^{Incl. VAT}



WS8

Wall-mounted controller for PREZONE88
Source selector, volume

Code : H10979

79€^{Incl. VAT}



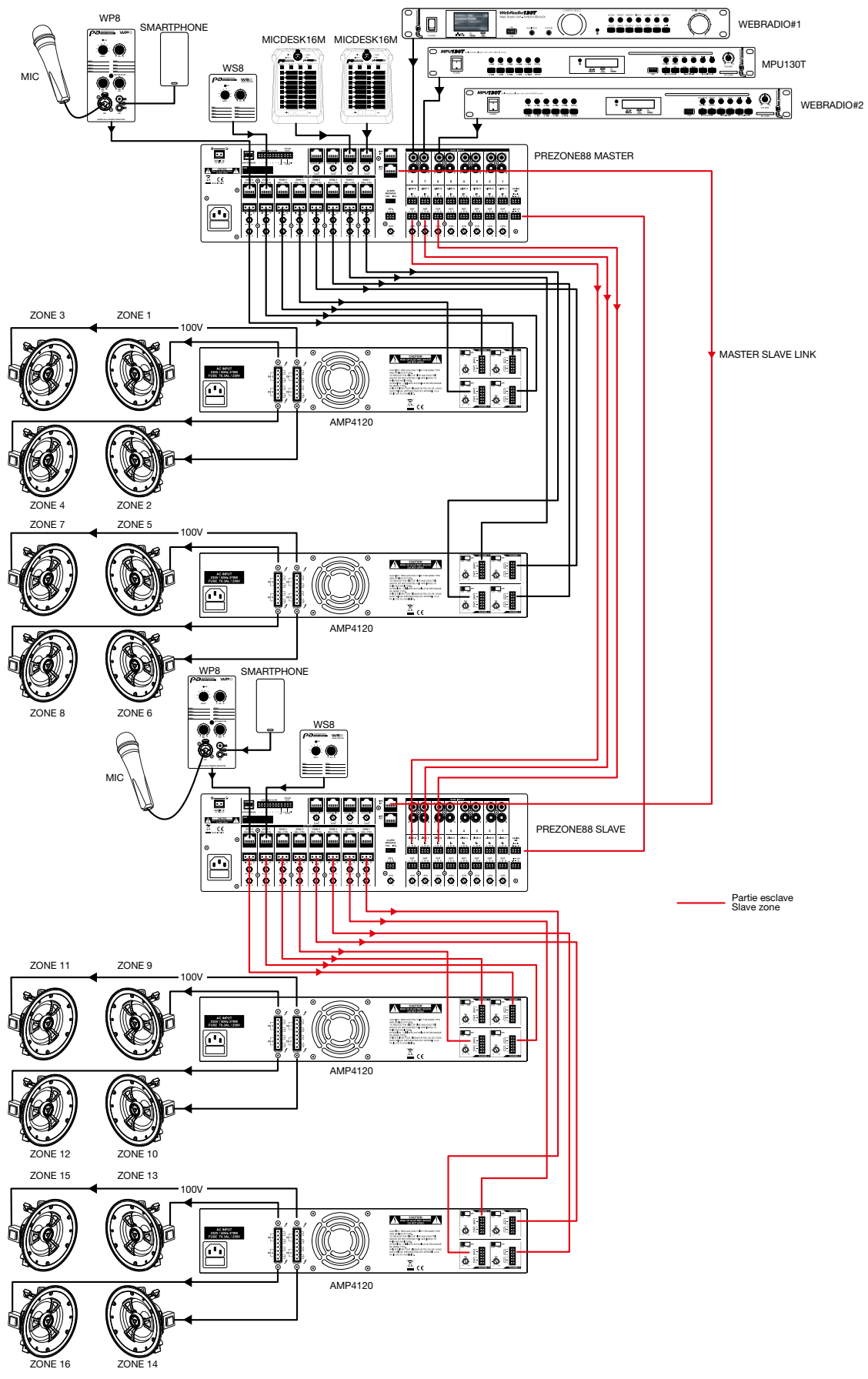

DIGITAL MATRIX

DZONE88 is an 8 audio digital input and 8 audio digital output matrix. It's entirely configurable and offers a large range of solutions for easy or more complicated installations thanks to its multi zone router. The matrix can be hub USB or ethernet configured and driven through the management software that is supplied.

Its 8 balanced inputs accept a MICRO or LINE level and can be freely directed through the 8 outputs. Its powerful DSP processor enables you to act on all input signal processing with : Alim Phantom, Anti-larsen, Noise Gate, Compressor, parametric EQ, AutoMix and on output with Parametric EQ, Delay, Compressor and limiters.

You also have 8 GPIO ports that can be set and used towards a specific functionality.



NEW

DZONE88
Digital matrix 8in 8out with software

Code : H11041 899€^{incl. VAT}

NEW

DCTL
Wall-mounted control box for DZONE88

Code : H11042 199€^{incl. VAT}

Sampling: 48 KHz / 24 bits
 Processor: 32-bit fixed/floating-point
 DSP 300MHz
 8 balanced MICRO / LINE inputs (Phoenix connectors, 3.81 mm, 12 pin)
 8 LINE level balanced outputs (Phoenix connectors, 3.81 mm, 12 pin)
 8 GPIO Ports, N°1-7 IN/OUT, N°8 OUT
 Control ports 1 x RS 485 1 x RS 232
 Parameter setting and control on PC via Ethernet (RJ45) or USB-B on the front panel
 DSP functions
 Input / Output Mixer
 For each input : 48V phantom power supply, Generators, Gain controls, AFC, Noise Gate, 21
 PEQ-X, Compressor.
 For each output : 10 PEQ-X, Delay, Compressor, Limiter.
 AutoMix and Matrix MIX function
 - Dimensions: 483 x 44.5 x 210 mm
 - Net weight : 2.8Kg

Main volume control
 Volume control for each input and output.
 Direct access to user presets
 Touch screen
 Color: 64K 16-bit RGB
 Communication interface: RS485
 Screen resolution: 320 x 240 pixels
 Screen size: 5.6 inches (72.5 x 70.5 mm)
 Product dimensions: 90.5 x 90.5 x 29 mm
 Voltage: 5-26V



DCTL is the remote control wall box for the DZONE88 matrix, by means of its touch screen, it enables you to act on all 8 inputs and outputs as well as on the matrix overall volume, it also allows you to select a preset user, memory stored when it was configured.



Flush-mounted box compatible with WALLAMPtouch and WALLAMPmedia

H10637 - PILOTBOX - Square back box 47 mm white
 H10638 - PILOTSCREW - Steel screw size M3.5x20 - 1 piece

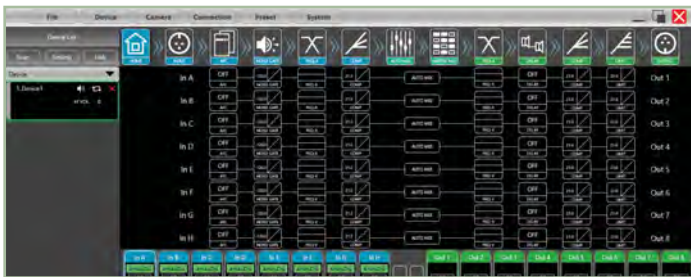
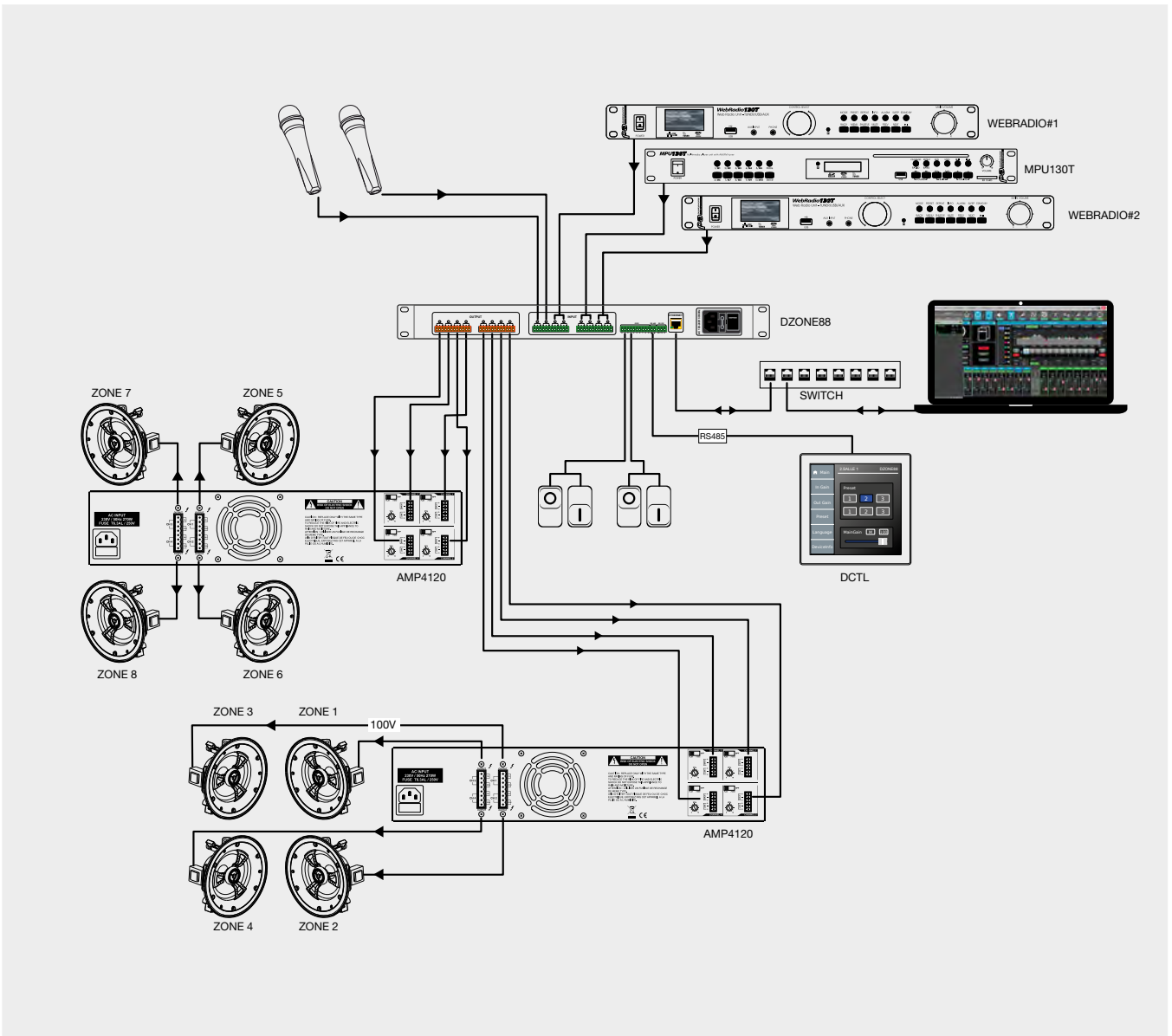

In and Out functions



31 points PEQ screen

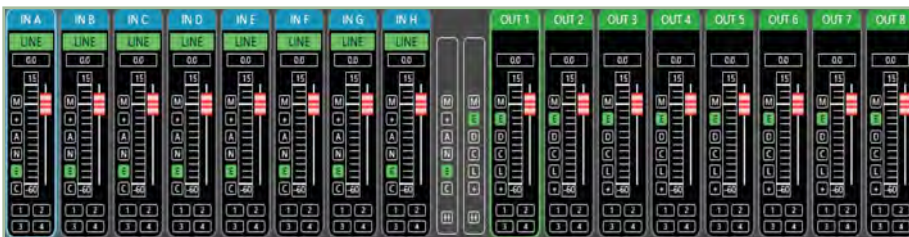

In and Out channel

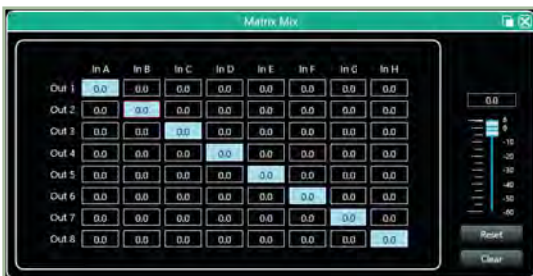

Matrix screen

WEBRADIO



Bluetooth™

MPU130BT

MP3 CD player + USB /SD + Tuner + BT

Code : H10961

399€^{Incl. VAT}



AVM protected USB/Mp3 player
 USB reader with a USB mass storage output (at the front, max 16Go, FAT32 formatted)
 Bluetooth 2.1
 SD and SDHC reader with a front slot (16 Go max)
 Output volume control
 AM/FM Tuner with autoscans and a 10 stations memory capacity
 A button allows you to browse the repertoires and tracks
 Infrared remote control supplied
 Random or programmable playlist
 Unbalanced [-10 dB] RCA output
 Mountable in 19" wide racks and ON/OFF power switch at the front
 Dimensions : 482 x 44 x 275 mm (1x19" unit)
 Power supply : 230 V, AC - 50 Hz or 12 V, DC
 Weight : 3.4 kg



SOURCE CONTROL

The MPU130T is a true multimedia centre capable of supplying a continuous sound atmosphere no matter what the source is. It's very easy to use thanks to its single output, it can be controlled independently by remote control, or directly from the front panel. Its USB and SD ports give access to hundreds of hours of non-stop music that can be pre-programmed or read randomly.

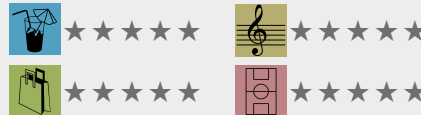

WEBRADIO130App

WEBRadio LAN WIFI+FM DAB+USB Reader + App

Code : H10963

499€^{Incl. VAT}



Radio: Ethernet / Wifi Internet radio, DAB and DAB+ digital radio, FM with RDS
 Mp3 reader: USB port for reading mp3/AAC/WMA/FLAC files on USB flash drive or FAT32 external disk drive
 Shared files: Audio file sharing available on your computer network to pool your favourite playlists
 Programmable power on:
 Infrared remote control
 Aux input on 3.5mm Jack
 Line level outputs on RCA and Headphone on 3.5mm Jack
 Power supply: 230V - 50/60Hz or DC12V
 Dimensions: 483 x 44 x 265 mm
 Net weight: 2.9 kg



- Internet or DAB radio for an international selection of digital music
- USB port to play MP3 files on your hard drive
- Share audio files on your computer network
- Webradio control by mobile application

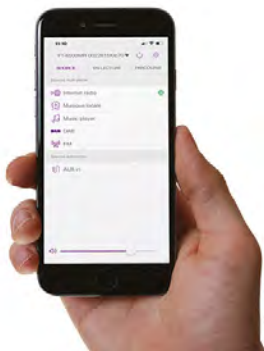
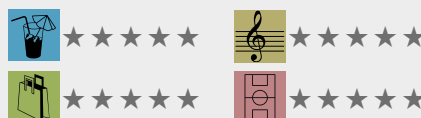

Webradio control by mobile application. Android and iOS compatible

WEBRADIO130APP

Radio stations from all over the
world come to your door



pa audiophony
public address

HEARING LOOP SYSTEM

More information :
<https://audiophony-pa.com>

On demand, feasibility study and site plan.

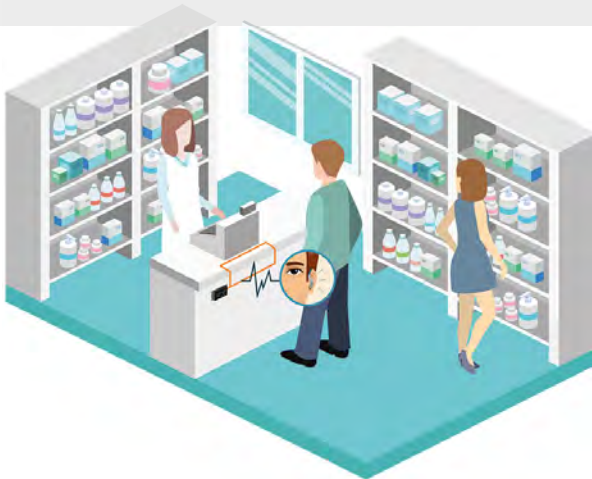

ABOUT THE HEARING LOOP SYSTEM

A hearing loop or induction loop is a hearing aid system for the hearing-impaired using a magnetic induction loop.

With this system, the sound from a speaker's microphone, PA equipment, TV set, etc. is transmitted wirelessly to the hearing aid of the person, who can hear it without being disturbed by any ambient noise. This system is mainly used in public places (conference rooms, cinemas, courts, churches, counters, etc.)

A large number of conventional hearing aids incorporate the "T" loop function. Hearing loops are mainly installed in rooms.

The installation consists of an electrical wire that travels around the perimeter of the room thus forming a loop. This loop is connected to an audio amplifier. The hearing aid has a coil, often called "T" or "T-coil".

This coil, placed inside the hearing aid, is also made of a wire that makes a large number of turns.

MAGNETIC FIELD

The magnetic field generated by the large loop around the room will cross the small loops in the hearing aid and, by the principle of induction, the electrical signal present in the large loop will end up in the small ones.

This is how the signal from the audio amplifier is transmitted to the hearing aid, which will then return it to the ear of the hearing-impaired person.



REGULATIONS

The 2005 - 102 Act of 11 February 2005 sets out the requirement for public establishments to be accessible to people with disabilities before 1 January 2018

This obviously applies to establishments open to the public, such as:

Administrative and cultural facilities,

Health buildings,

Sports facilities,

But also supermarkets, cinemas, public transport, etc.

Facilities must comply with the standard: EN 60118-4:

Background noise (electromagnetic pollution) must be < 32 dB at 400 mA/m

The magnetic field must be between +/- 3 dB for a signal from 1 kHz to 400 mA/m

The frequency response must be 100 Hz - 5 kHz at +/- 3dB



BM-PORTABLE

Portable and autonomous loop amplifier

Code : H10799 249€^{Incl. VAT}



This portable loop system makes it easy to equip a desk or counter. Made of ABS, it has an integrated microphone, amplifier, rechargeable battery and an induction loop for a coverage of: 1.2 m². Charger included.



BM-KIT

Loop amplifier kit for counter use

Code : H10795 259€^{Incl. VAT}



Induction loop kit for equipping: counters, reception desks or service desks. This kit includes: 1 x induction loop amplifier 1 x surface microphone 1 x loop 1 x power supply 3 x "Space adapted for the hearing-impaired" stickers. 2 inputs: 1 microphone/line and 1 line Phantom power Compressor and noise limiter Output protection and control Power: 230 V 50/60 Hz - 12 V DC 1.5 A Size: 92 x 52 x 18 mm Weight: 0.850 kg



BM-A250

Loop amplifier for 250 m² area

Code : H10796 799€^{Incl. VAT}



Class D amplifier for approximately 250 m²
3 inputs: 2 line or microphone inputs (connector: 1 Phoenix and Combo), 1 priority 100 V input
Monitoring and detection of power supply, amplifier and loop faults with NO-NC relay.
Automatic gain control
Correction control due to metal losses
Power: 230 V 50/60 Hz
Size: 483 x 43 x 215 mm
Weight: 2.47 kg



BM-A1000

Loop amplifier for 1000 m² area

Code : H10797 999€^{Incl. VAT}



Class D amplifier for approximately 1000 m²
3 inputs: 2 line or microphone inputs (connector: 1 Phoenix and Combo), 1 priority 100 V input
Monitoring and detection of power supply, amplifier and loop faults with NO-NC relay.
Integrated phase shift module (output 90° or 0°)
Automatic gain control
Correction control due to metal losses
Power: 230 V 50/60 Hz
Size: 483 x 43 x 215 mm
Weight: 2.47 kg



BM-TEST

Hearing aid simulator for loop amp test

Code : H10798 179€^{Incl. VAT}



BM-TEST is a compact listening device for magnetic induction loop systems. It can be used in different situations:

- To determine if an induction loop is working properly
- For hearing-impaired people who do not wear a hearing aid
- For wearers of hearing aids that do not have a "T" function

The kit comprises:

- 1 x loop receiver
- 1 x headset
- 2 x AAA batteries

Frequency response: 20 Hz - 6 kHz
Battery life: >100 hours



BM-SCAN

Magnetic field meter

Code : H10878 999€^{Incl. VAT}



The BM-SCAN field strength meter has been designed to ensure that magnetic loop systems are installed and certified according to the new IEC 60118-4 standard. When these standards are met, the comfort of the user will be identical wherever he/she uses a hearing aid with the T position.

3.5 mm headphone jack socket
Power supply: 9 V battery (not included)



BM-Cu50

Copper tape 50 m - 18 mm wide x 0.1 mm thick

Code : H10800 149€^{Incl. VAT}



The BM-Cu50 is an 18-mm wide, 0.1-mm thick (1.8 mm² cross-section) copper tape insulated by a 0.05 mm Melinex band. Resistance +/- 10mΩ/m.
Cables specially designed for induction loops where the loop must go under carpets or in places not suitable for conventional cables.

50 m coil



BM-Cu100

Copper tape 100 m - 18 mm wide x 0.1 mm thick

Code : H10801 299€^{Incl. VAT}



The BM-Cu100 is a 18 mm wide, 0.1-mm thick (1.8 mm² cross-section) copper tape insulated by a 0.05 mm Melinex band. Resistance +/- 10mΩ/m.
Cables specially designed for induction loops where the loop must go under carpets or in places not suitable for conventional cables.

100 m coil

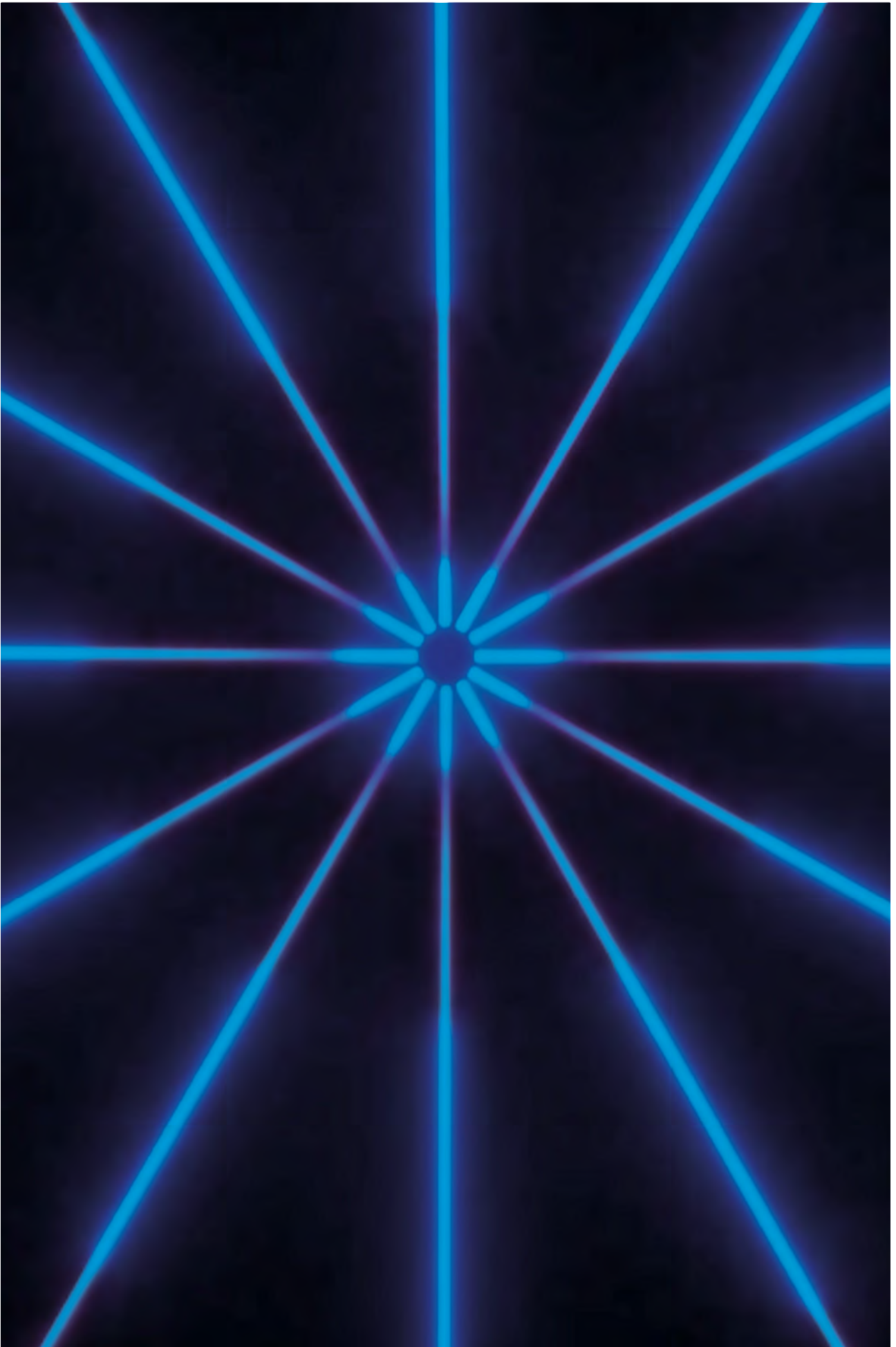

LIGHT INTEGRATION

LED RIBBONS
SMART PIXEL
CONTROLLERS
DRIVERS
BOOSTERS AND MANAGERS
POWER SUPPLIES
PROFILES AND DIFFUSERS
ACCESSORIES

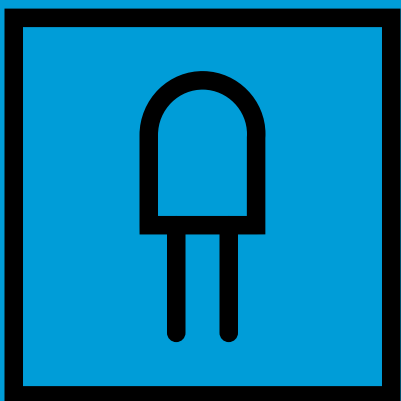

ADVANTAGES of the LEDs?

- Long life, low maintenance
- Low energy cost
- Resistant to shocks and vibrations
- Very compact format
- No infrared and UV emissions

Ra
80

RA OR CRI

An Ra equal to 100 corresponds to natural daylight. At this level, the colours are perceived without any change (or loss) for the human eye.

LEDs which diffuse artificial light cannot claim an CRI greater than 90. In places that require that colours are complied with (e.g. points of sale or exhibitions), it is essential to provide equipment with an index greater than 70).

COLOUR TEMPERATURE

The unit of colour temperature is Kelvin degree (K°).

The lower the degree of temperature, the warmer the light. The higher the degree of temperature, the colder the light.



WHAT TYPE OF LED?



—
5054: 4 chips (RGBW)
of 0.32w/led
Good brightness



—
5630: 1 chip of 0.33w/led
Very high brightness
Only monochrome



—
5050: 3 chips (RGB) of
0.24w/led
Good brightness



—
5050: 1 hot white or cold
white chip of 0.24w/led
High brightness

Ideal for ambient lighting



—
3527: 2 chips (warm white
cold white) of 0.16w/led



—
WS2812B:
3 RGB chips of 0.24w/led with integrated control circuit
Each LED can be controlled independently

LED RIBBONS

Intense colours, bright white or softened light, our ribbons ensure an exceptional rendering in ambient lighting as well as enhancing your spaces.

IP67	60 LEDs/m	LED SMD 5050	Ra 80
PURETAPE6067-WARM 3000°K White LED ribbon Roll of 5 meters - IP67 - 60 LEDs/meter			
Code : H9861		89€ ^{Incl. VAT}	
Contest			

Monochrome adhesive ribbon of 300 warm white LEDs for 5m
Width: 12,5 mm
Colour temperature: 3000°K
Luminosity: 1080 lumens/m
Power required: 14.4W/m (72W for 5m)
Voltage required: 24V (+ and -)
Cuttable every 10 cm (6LEDs)
IP67: Full silicone sheath

IP20	144 LEDs/m	LED SMD 5630	Ra 80
PURETAPE14420-WARM 3000°K White LED ribbon Roll of 5 meters - IP20 - 144 LEDs/meter			
Code : H10536		229€ ^{Incl. VAT}	
Contest			

Double monochrome adhesive ribbon of 720 warm white LEDs for 5m
Width: 20 mm
Colour temperature: 3000°K
Luminosity: 2452 lumens/m
Power required: 47.5W/m (238W for 5m)
Voltage required: 24V (+ and -)
Cuttable every 8.4 cm (12 LEDs)
IP20: no protection no sealing

IP20	60 LEDs/m	LED SMD 5050	Ra 80
PURETAPE6020-WARM 3000°K White LED ribbon Roll of 5 meters - IP20 - 60 LEDs/meter			
Code : H10535		69€ ^{Incl. VAT}	
Contest			

Monochrome adhesive ribbon of 300 warm white LEDs for 5m
Width: 10 mm
Colour temperature: 3000°K
Luminosity: 915 lumens/m
Power required: 14.4W/m (72W for 5m)
Voltage required: 24V (+ and -)
Cuttable every 10 cm (6LEDs)
IP20: no protection no sealing

IP67	60 LEDs/m	LED SMD 5050	Ra 85
PURETAPE6067-COLD 6000°K White LED ribbon Roll of 5 meters - IP67 - 60 LEDs/meter			
Code : H9862		89€ ^{Incl. VAT}	
Contest			

Monochrome adhesive ribbon of 300 Colour temperature: 6000°K
Width: 12,5 mm
Luminosity: 1170 lumens/m
Power required: 14.4W/m (72W for 5m)
Voltage required: 24V (+ and -)
Cuttable every 10 cm (6LEDs)
IP67: Full silicone sheath

IP20	60 LEDs/m	LED SMD 5050	Ra 85
PURETAPE6020-COLD 6000°K White LED ribbon Roll of 5 meters - IP20 - 60 LEDs/meter			
Code : H10537		69€ ^{Incl. VAT}	
Contest			

Monochrome adhesive ribbon of 300 cold white LEDs for 5m
Width: 10 mm
Colour temperature: 6000°K
Luminosity: 1190 lumens/m
Power required: 14.4W/m (72W for 5m)
Voltage required: 24V (+ and -)
Cuttable every 10 cm (6LEDs)
IP20: no protection no sealing

IP20	144 LEDs/m	LED SMD 5630	Ra 85
PURETAPE14420-COLD 6000°K White LED ribbon Roll of 5 meters - IP20 - 144 LEDs/meter			
Code : H10538		229€ ^{Incl. VAT}	
Contest			

Double monochrome adhesive ribbon of 720 cold white LEDs for 5m
Width: 20 mm
Colour temperature: 6000°K
Luminosity: 3065 lumens/m
Power required: 47.5W/m (238W for 5m)
Voltage required: 24V (+ and -)
Cuttable every 8.4 cm (12 LEDs)
IP20: no protection no sealing

IP20	120 LEDs/m	LED SMD 3527	Ra 80-85
PURETAPE12020-WARMCOLD 3000+6000°K White LED ribbon Roll of 5 meters - IP20 - 120 LEDs/meter			
Code : H10539		149€ ^{Incl. VAT}	
Contest			

Two-tone adhesive ribbon of 600 warm and cold white LEDs for 5m
Width: 10 mm
Colour temperature: 3500K/6500K
Luminosity: 1264 lumens/m
Power required: 19.2 W/m (96W for 5m)
Voltage required: 24V (+ and -)
Cuttable every 5.3cm (6 LEDs)
IP20: no protection no sealing

IP67	120 LEDs/m	LED SMD 3527	Ra 80-85
PURETAPE12067-WARMCOLD 3000+6000°K White LED ribbon Roll of 5 meters - IP67 - 120 LEDs/meter			
Code : H10540		159€ ^{Incl. VAT}	
Contest			

Two-tone adhesive ribbon of 600 warm and cold white LEDs for 5m
Width: 12,5 mm
Colour temperature: 3500K/6500K
Luminosity: 1264 lumens/m
Power required: 19.2 W/m (96W for 5m)
Voltage required: 24V (+ and -)
Cuttable every 5.3cm (6 LEDs)
IP67: Full silicone sheath



LED RIBBONS

IP67	60 LEDs/m	LED SMD 5050
------	-----------	--------------



COLORTAPE6067
3-colour LED ribbon
Roll of 5 meters - IP67 - 60 LEDs/meter

Code : H9860 89€^{Incl. VAT}

Contest® 

Trichromatic adhesive ribbon of 300 RGB LEDs for 5m
Width: 12,5 mm
Luminosity: 510 lumens/m
Power required: 14,4W/m (72W for 5m)
Voltage required: 24V (+ and -)
Cuttable every 10 cm (6 LEDs)
IP67: Full silicone sheath

IP65	60 LEDs/m	LED SMD 5050
------	-----------	--------------



COLORTAPE6065
3-colour LED ribbon
Roll of 5 meters - IP65 - 60 LEDs/meter

Code : H9994 79€^{Incl. VAT}

Contest® 

Trichromatic adhesive ribbon of 300 RGB LEDs for 5m
Width: 11 mm
Luminosity: 510 lumens/m
Power required: 14,4W/m (72W for 5m)
Voltage required: 24V (+ and -)
Cuttable every 10 cm (6 LEDs)
IP65: Upper molded silicone dome

IP65	30 LEDs/m	LED SMD 5050
------	-----------	--------------



COLORTAPE3065
3-colour LED ribbon
Roll of 5 meters - IP65 - 30 LEDs/meter

Code : H9859 59€^{Incl. VAT}

Contest® 

Trichromatic adhesive ribbon of 150 RGB LEDs for 5m
Width: 10 mm
Luminosity: 255 lumens/m
Power required: 7,2W/m (36W pour 5m)
Voltage required: 24V (+ and -)
Cuttable every 16,8 cm (6 LEDs)
IP65: Upper molded silicone dome

IP20	60 LEDs/m	LED SMD 5050
------	-----------	--------------



COLORTAPE6020
3-colour LED ribbon
Roll of 5 meters - IP20 - 60 LEDs/meter

Code : H10541 69€^{Incl. VAT}

Contest® 

Trichromatic adhesive ribbon of 300 RGB LEDs for 5m
Width: 10 mm
Luminosity: 560 lumens/m
Power required: 14,4W/m (72W for 5m)
Voltage required: 24V (+ and -)
Cuttable every 10 cm (6 LEDs)
IP20: no protection no sealing

IP20	60 LEDs/m	LED SMD 5054	Ra 80-85
------	-----------	--------------	----------



COLORTAPE6020-WARM
LED ribbon 4-colour
Roll of 5 meters - IP20 - 60 LEDs/meter

Code : H10542 129€^{Incl. VAT}

Contest® 

Ribbon of 300 4-colour RGBW LEDs for 5m
Width: 12 mm
Luminosity: 879 lumens/m
Power required: 19,2W/m (96W for 5m)
Voltage required: 24V (+ and -)
Cuttable every 10 cm (6 LEDs)
IP20: no protection no sealing

IP67	60 LEDs/m	LED SMD 5054	Ra 80-85
------	-----------	--------------	----------



COLORTAPE6067-WARM
4-colour LED ribbon
Roll of 5 meters - IP67 - 60 LEDs/meter

Code : H10543 139€^{Incl. VAT}

Contest® 

Ribbon of 300 4-colour RGBW LEDs for 5m
Width: 14 mm
Luminosity: 646 lumens/m
Power required: 19,2W/m (96W for 5m)
Voltage required: 24V (+ and -)
Cuttable every 10 cm (6 LEDs)
IP67: Full silicone sheath

LED RIBBONS



FLEX LED PIXEL

The ribbons of the SMARTTAPE range are equipped with the latest WS2812B LED technology. In SMD5050 (5x5mm) format, the integrated control circuit is directly embedded in the component. More discreet, these LEDs make it possible to have ribbons of only 10mm width with a pitch of only 16mm for the SMARTTAPE6020 model.

The installation is very simple, as only 3 cables are needed for operation ("+", "-", Data in).

Associated with a power supply and a SMARTCTL controller, you will get 300 kinds of patterns with the ability to control the speed and brightness.

IP20	30 LEDs/m	LED WS2812B	PIXEL
------	-----------	-------------	-------

SMARTTAPE3020
3-colour pixel LED strip of 30 LEDs/meter - IP20 - 5V

Code : H10596 65€^{Incl. VAT}



3-colour adhesive ribbon of 150 RGB LEDs for 5m pixel version
Width: 10 mm
Power required: 7.2W/m (36W pour 5m)
Voltage required: 5V DC
Cuttable every 3.3cm (1 LED)
IP20: no protection no sealing



IP20	60 LEDs/m	LED WS2812B	PIXEL
------	-----------	-------------	-------

SMARTTAPE6020
3-colour pixel LED strip of 60 LEDs/meter - IP20 - 5V

Code : H10597 99€^{Incl. VAT}



3-colour adhesive ribbon of 300 RGB LEDs for 5m pixel version
Width: 10 mm
Power required: 14.4W/m (72W for 5m)
Voltage required: 5V DC
Cuttable every 1.6 cm (1 LED)
IP20: no protection no sealing



IP65	60 LEDs/m	LED WS2812B	PIXEL
------	-----------	-------------	-------

SMARTTAPE6065
5m - IP65 - 60 LEDs/m-5V

Code : H10972 119€^{Incl. VAT}



Voltage: 5 V DC
Power/m: 14,4 W
Length of each ribbon: 5 m
Width: 11 mm
Sectile parts: 1,6 cm (1 LED)



IP67	60 LEDs/m	LED WS2812B	PIXEL
------	-----------	-------------	-------

SMARTTAPE6067
TRI pixel ribbon - 5m - IP67 - 60 LEDs/m-5V

Code : H10973 129€^{Incl. VAT}



Voltage: 5 V DC
Power/m: 14,4 W
Length of each ribbon: 5 m
Width: 12,5 mm
Sectile parts: 1,6 cm (1 LED)



SMARTCTL
HF remote control for SMARTTAPE ribbons of 2048 pixel max. - DC 5V

Code : H10598 22€^{Incl. VAT}



Power supply: 5V DC
Max controlled number of pixels: 2048
Remote control : 433.92 MHz
Remote control range: 30m

NEW



SmartCTL-BTM
BT 960 Pixel Matrix Controller 960 pixels - DC 5V

Code : H11038 45€^{Incl. VAT}



"LED CHORD" iOS and Android application
For LED WS2811 and 2812B
Bluetooth® 4.0
200 built-in animations
Controls up to 960 matrix pixels
Power supply DC 5V

NEW



SmartCTL-BTL
Bluetooth Controller 4.0 2048 pixels iOS/Android APP - DC 5V

Code : H11037 45€^{Incl. VAT}



"MAGIC LED" iOS and Android application
For LED WS2811 and 2812B
Bluetooth® 4.0
Controls up to 2048 pixels online
Power supply DC 5V



SMART PIXEL

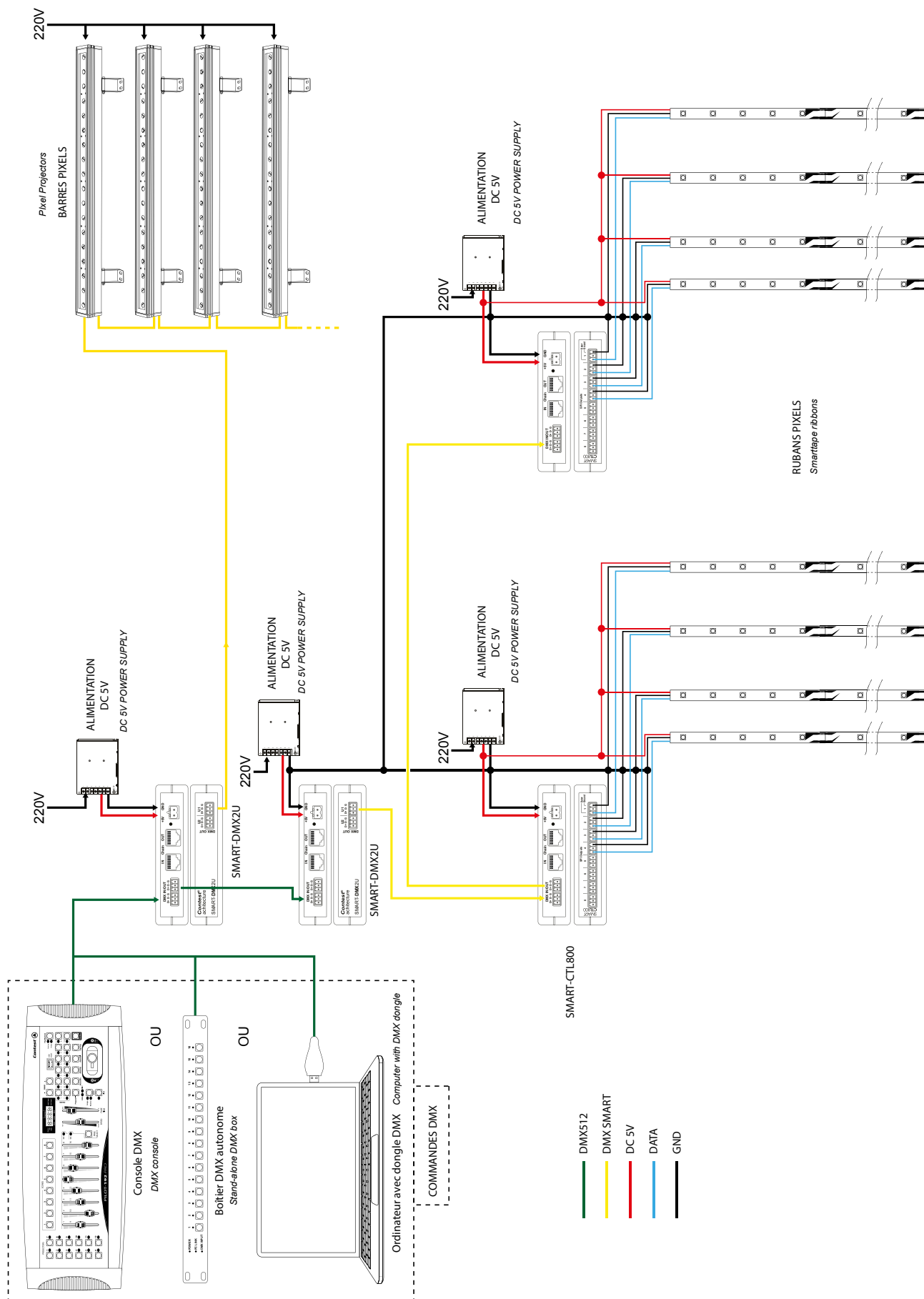

PIXELS CONTROLLERS



SMART-CTL800

800 LED pixel ribbon controller - 8 SPI outputs

Code : H10949

589€^{Incl. VAT}



SMARTAPE controller (LEDs WS2811, 2812 etc.)
 Inputs : DMX operation (16 channels) with dedicated software (simulator), stand alone mode
 Outputs: 8 Euroblock SPI outputs, max. 800 pixels to be distributed over the 8 outputs.
 Programming: RDM configuration and programming via Smart USB
 Power supply: 5 V DC Euroblock connectors
 DMX in/out: Euroblock connectors
 Dimensions: 130 x 100 x 100 x 30 cm
 Weight: 150 g



SMART-DMX2U

DMX controller for SMART-CTL800 or DMX pixel bars

Code : H10968

589€^{Incl. VAT}



Controls up to 128 SMART-CTL800s with 16 DMX channels
 Inputs : DMX (16 channels), simulator with specific software, stand alone mode
 Outputs: 2 DMX Euroblock outputs, 2x 512 DMX channels
 Programming: RDM configuration and programming via Smart USB
 Power supply: 5 V DC Euroblock connectors
 DMX in/out: Euroblock connectors
 Dimensions: 130 x 100 x 100 x 30 cm
 Weight: 150 g



SMART-USB

RDM interface for simul + pixel controller program

Code : H10948

169€^{Incl. VAT}



USB/DMX interface for configuring the installation in RDM.

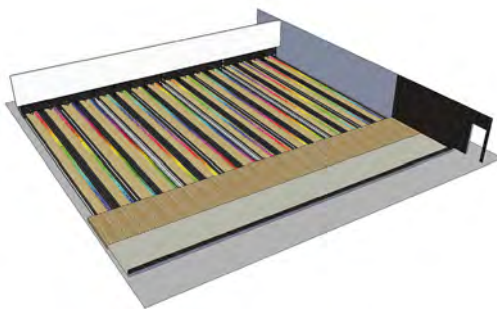

Flex LED Installation Simulator for Smarttape
 Configuration of smart controllers with RDM
 Standalone memory management
 Program creator

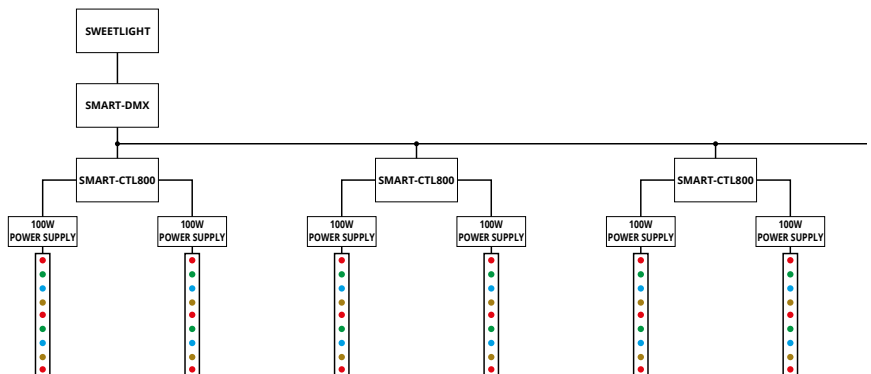

TOUCH CONTROLLERS

Light at your fingertips.

Discover our new range of fully tactile and recessed LED light controllers. Fluid and highly accurate, choose the intensity and colour of your flex LED light with the tip of your finger.

288 W
24 V



PILOTdrive-1
Monochrome ribbon controller
3 x 4A - 12-24V - 12A max.

Code : H10560 45€^{Incl. VAT}

Contest® 

Function:
- Dimmer 5% to 100% monochrome
- Direct access to a recorded scene
- «30S» Extinction of the ribbon after 30 seconds
Power supply: 12 - 24V DC
Intensity (Max load in amperes) :
4A x 3 (outputs) = 12A max
Dimensions: 86 x 86 x 36 mm
Weight: 208 g

192 W
24 V



PILOTdrive-2
Controller for warm and cold white ribbons
2 x 4A - 12 - 24V - 8A max.

Code : H10561 45€^{Incl. VAT}

Contest® 

Function:
- Dimmer 5% to 100% warm/cold white
- Direct access to a recorded scene
- "Mode" to switch between hot and cold
Power supply: 12 - 24V DC
Intensity (Max load in amperes) :
4A x 2 (outputs) = 8A max
Dimensions: 86 x 86 x 36 mm
Weight: 208 g

NEW **288 W**
24 V



PILOTdrive-3 MKII
RGB Ribbons control + Power - 3x4A -
12-24V - 12A max.

Code : H10990 55€^{Incl. VAT}

Contest® 

Function:
- RGB Dimmer 5 % à 100 %
- Direct access to a saved scene
- 11 preset modes
Format : Wall-mountable
Power supply: 12 - 24 V DC
Intensity (Max load, in Amps): 4 A x 3
(outputs) = 12 A max
Dimensions: 86 x 86 x 36 mm
Weight: 208 g

384 W
24 V



PILOTdrive-4
RGBW ribbon controller
4 x 4A - 12-24V - 16A max.

Code : H10563 55€^{Incl. VAT}

Contest® 

Function:
- Dimmer 5% to 100% RGBW
- Direct access to a recorded scene
- 12 modes- Direct access to white (fixed + step + fade colours)
Power supply: 12 - 24V DC
Intensity (Max load in amperes) :
4A x 4 (outputs) = 16A max
Dimensions: 86 x 86 x 36 mm
Weight: 208 g

2,4 GHz **DMX**
1 CH



PILOTctl-1
DMX controller + 2.4 GHz -1 zone - 1 colour

Code : H10564 59€^{Incl. VAT}

Contest® 

Function:
- Dimmer 5% to 100% monochrome
- Direct access to a recorded scene
- «30S» Extinction of the ribbon after 30 seconds
Power supply: 240V
Output signal: 2.4 GHz & DMX512
Operating distance: 30m and 2.4 Ghz
Dimensions: 112 x 112 x 48 mm
Weight: 225 g

2,4 GHz **DMX**
2 CH



PILOTctl-2
DMX controller + 2.4 GHz -1 zone - 2 colours

Code : H10565 65€^{Incl. VAT}

Contest® 

Function:
- Dimmer 5% to 100% warm/cold white
- Direct access to a recorded scene
"Mode" to switch between warm and cold white
Power supply: 240V
Output signal: 2.4 GHz & DMX512
Operating distance: 30m and 2.4 Ghz
Dimensions: 112 x 112 x 48 mm
Weight: 225 g

2,4 GHz **DMX**
3 CH



PILOTctl-3
DMX controller + 2.4 GHz -1 zone - 3 colours

Code : H10566 69€^{Incl. VAT}

Contest® 

Function:
- Dimmer 5 % to 100 % RGB
- Direct access to a recorded scene
- 11 modes (fixed + step + fade colours)
Power supply: 240V
Output signal: 2.4 Ghz & DMX512
Operating distance: 30m and 2.4 Ghz
Dimensions: 112 x 112 x 48 mm
Weight: 225 g

2,4 GHz **DMX**
4 CH



PILOTctl-4
DMX controller + 2.4 GHz -1 zone - 4 colours

Code : H10567 75€^{Incl. VAT}

Contest® 

Function:
- Dimmer 5% to 100% RGBW
- Direct access to a recorded scene
- 12 modes (fixed + step + fade colours)
- Direct access to white on 4 zones
Power supply: 240V
Output signal: 2.4 GHz & DMX512
Operating distance: 30m and 2.4 Ghz
Dimensions: 112 x 112 x 48 mm
Weight: 225 g



Flush-mounted box compatible with PILOTdrive and PILOTctl

H10637 - PILOTBOX - Square back box 47 mm white

H10638 - PILOTSCREW - Steel screw size M3,5x20 - 1 piece

4 ZONES
 2,4 GHz
DMX 4x4 CH

PILOTctl-16
DMX Controller + 2,4 GHz
4 zones - 4 colours per zone

Code : H10568
85€^{Incl. VAT}

Function

- Dimmer 5% to 100% RGBW
- Direct access to a recorded scene
- 12 modes (fixed colour + step + fade colours)
- Direct access to white

Power supply: 240V
Output signal: 2.4 Ghz & DMX512
Operating distance: 30m and 2.4 Ghz
Dimensions: 112 x 112 x 48 mm
Weight: 225 g
Compatible with PILOTdrive and PILOTctl

Wi-Fi
 2,4 GHz
RGBW

TAPElive4
Wi-Fi transmitter receiver for driver
TAPEDRIVER-WIFI4 2.4 GHz remote control

Code : H10572
259€^{Incl. VAT}

Mode of communication: 2.4GHz Wi-Fi, 802.11b/g/n protocol
Power supply: 12-24V DC
Operating distance: Approx. 100m
Intensity: 4A x 4 (outputs) = 16A max
Power rating: 192W / 384W (12V / 24V)
Dimensions: 128 x 73 x 45 mm
Weight: 382 g
Remote Control 2.4GHz included

2,4 GHz
4 CH

TAPEDRIVER-WIFI4
2.4GHz wi-Fi Controller
4 channels - 5-24VDC - 4 x 5A max.

Code : H10580
89€^{Incl. VAT}

Mode of communication: 2.4GHz Wi-Fi
Power supply: 5 - 24V DC
Operating distance: 30m with its remote control
Intensity: 5A x 4 (outputs) = 20A max
Power rating: 100W / 240W / 480W (5V / 12V / 24V)
Dimensions: 175 x 44 x 30 mm
Weight: 150 g

POSSIBLE CONFIGURATIONS

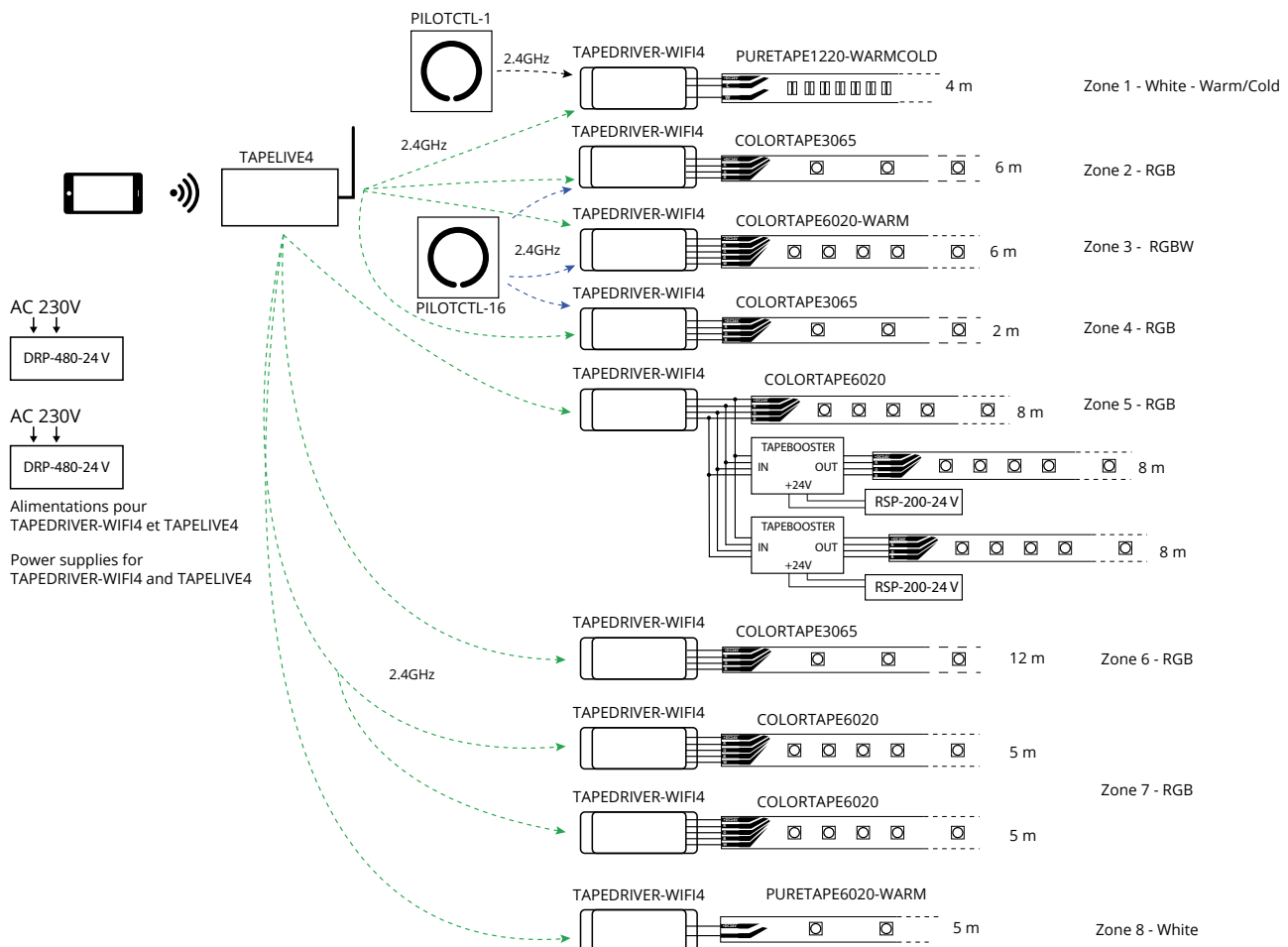

DMX DRIVERS

2,4 GHz 3 CH



TAPEDRIVER-RF3
2.4GHz Controller
3 channels - 5-24VDC 3 x 6A max.

Code : H10577 85€^{Incl. VAT}



Mode of communication: 2.4GHz
Power supply: 5 - 24V DC
Intensity (max charge in amperes) :
6A x 3 (outputs) = 18A max
Power rating: 90W / 216W / 432W
(5V / 12V / 24V)
Compatible remote control :
REMOTERF-8W & REMOTERF-10RGB
Operating distance: 30m
Dimensions: 175 x 44 x 30 mm
Weight: 150 g

2,4 GHz RGB



TAPEDRIVERTOUCH-RF3
Manual controller and 2.4GHz
3 channels - 12-24V DC - 3x 5A max.

Code : H10578 85€^{Incl. VAT}



Mode of communication: 2.4GHz or manual
Power supply: 12 - 24V DC
Intensity (max charge in amperes) :
5A x 3 (outputs) = 15A max
Power rating: 180 W / 360 W (12 V / 24 V)
Compatible remote control :
REMOTERF-10RGB
Operating distance: 30m
Dimensions: 211 x 40 x 30
Weight: 180 g

2,4 GHz 4 CH



TAPEDRIVER-RF4
2.4GHz Controller
4 channels - 5-24VDC - 4 x 5A max.

Code : H10579 99€^{Incl. VAT}



Mode of communication: 2.4GHz
Power supply: 5 - 24V DC
Intensity (max charge in amperes) :
5A x 4 (outputs) = 20A max
Power rating: 100 W / 240 W / 480 W
(5 V / 12 V / 24 V)
Compatible remote control :
REMOTERF-8RGBW
Operating distance: 30m
Dimensions: 175 x 44 x 30 mm
Weight: 150 g

8 zones
WHITE



REMOTERF-8W
2.4GHz remote controller
8 zones - 1 colour

Code : H10569 85€^{Incl. VAT}



Mode of communication: 2.4GHz
Power supply: DC 5V (Lithium) - Mini
USB rechargeable battery
Number of controlled zones: 8 zones
Driver pilot: TAPEDRIVER-RF3
Operating distance: 30m

10 zones
RGB



REMOTERF-10RGB
2.4GHz remote controller
10 zones - 3 colours

Code : H10570 119€^{Incl. VAT}



Mode of communication: 2.4GHz
Power supply: DC 5V (Lithium) - Mini
USB rechargeable battery
Number of controlled zones: 10 zones
- Direct access to a recorded scene
- 11 modes (fixed + step + fade colours)
Driver pilot: TAPEDRIVER-RF3 and
TAPEDRIVERTOUCH-RF3
Operating distance: 30m

8 zones
RGBW



REMOTERF-8RGBW
Remote control, 2.4GHz 8 zones ribbon
driver RF4

Code : H10571 129€^{Incl. VAT}



Communication mode: 2.4GHz
Power supply: DC 5V (Lithium) -
Rechargeable battery in mini USB
Number of controlled zones: 8 zones
- Direct access to a recorded scene
- 11 recorded modes (fixed colors + step
+ fade)
- Synchro mode on 1 zone
Driver driven: TAPEDRIVER-RF4
Operating distance: 30m



NO WIRING BETWEEN THE DRIVERS

Our drivers are not wired together.
The information sent by the remote control automatically
synchronizes with the drivers thanks to the 2.4GHz Wi-Fi
technology.



TAPEDRIVER-1

DMX controller for ribbons
1 channel - 12-24VDC - 6A max.

Code : H10573 49€^{incl. VAT}



For monochrome ribbon
DMX 1 channel
144W under 24V
Dimmer by dip-switches
Command in 0-10V control



TAPEDRIVER-3

DMX controller for ribbons
3 channels - 12-24VDC - 3 x 2A max.

Code : H10574 59€^{incl. VAT}



For RGB ribbon
DMX 3 channels
144W under 24V
Choice of programs and colours by
dip-switches



LED DMX-CONTROL SCREW MK2

360W/24V LED Ribbon Controller

Code : B05399 38,90€^{incl. VAT}



For monochrome and RGB ribbon
DMX 4 channels
60 W/ channel = 180 W under 12 VDC
120 W/ channel = 360 W under 24 VDC
Choice of programs and colours by
dip-switches
WTR-DMX DONGLE compatible



LED DMX-CONTROL XLR Mk2

LED controller - DMX - 240W/24V

Code : B05401 39,90€^{incl. VAT}



For monochrome and RGB ribbon
DMX 4 channels
40 W/ channel = 120 W under 12 VDC
80 W/ channel = 240 W under 24 VDC
Choice of programs and colours by
dip-switches and DMX



TAPEDRIVER-4

DMX controller for ribbons
4 channels - 12-24VDC - 4 x 2.5A max.

Code : H10575 85€^{incl. VAT}



For RGBW ribbon
DMX 4 channels
240 W under 24 V
Choice of programs and colours by
dip-switches



TAPEDRIVER-12

DMX controller for ribbons
12 channels - 12-24VDC - 12 x 5A max.

Code : H10576 149€^{incl. VAT}



For all types of 24V ribbons
DMX 12 channels
1440 W under 24 V



DMX OPERATION

Example for a RGB ribbon
(3 channels)

Channel 1 : Red
Dimmer 0%-100%

Channel 2 : Green
Dimmer 0%-100%

Channel 3 : Blue
Dimmer 0%-100%

BOOSTERS AND MANAGERS



TAPEDIMMER

Dimmer for monochrome ribbon
24V - 432 Watts maximum

Code : H9866 49€^{Incl. VAT}



Compatible with monochrome ribbons
Rotary potentiometer to adjust the output level
Power supply: 24 V DC
Maximum power: 432W in 24V -
Dimensions: 112 x 65 x 24 mm
Weight: 0.5 Kg



LED 1CH DIM WALL

12V / 24V Wall dimmer

Code : B05392 10,90€^{Incl. VAT}



Compatible with monochrome ribbons
Rotary potentiometer to adjust the output level
IR remote control for M/A, standby, dimmer, 4 levels.
Power supply: 12 or 24V DC
Maximum power: 160W in 24V - 80W in 12V
Dimensions: 87 x 87 x 53 mm (box)
Weight: 0.150 Kg



DOORSENSOR

Door opening sensor 24V 2A max

Code : H11036 25€^{Incl. VAT}



Compatible with monochrome tapes
Operating distance 3-8 cm
On off with blind
Power supply: 24 V DC
Maximum power: 50w



LED WALL DIMMER

Compact RGB remote control for LED projectors

Code : B04936 39€^{Incl. VAT}



Compatible with 3-colour and monochrome ribbons:
Colour adjustment by potentiometer (with access to a fade program)
Adjustment of brightness/strobe by potentiometer
Setting the speed in Fade mode
2 adjustment memories
1 bouton Black Out (ON/OFF)
DMX 4 channels:
Red, Green, Blue, General/Strobe Dimmer
Power supply: DC12V - 1A (not provided)
Dimensions: 84 x 83 x 40 mm
Weight: 0.5 kg



TAPEBOOSTER-RGBW

Compatible with 4-colour, 3-colour and monochrome ribbons, this signal booster increases the number of ribbons connected on a serial controller.

Combined with a suitable power supply, it amplifies the received signal and allows you to connect more ribbons to the same controller for longer hose lengths without discontinuity or difference in brightness.



TAPEBOOSTER-1X10A

1 channel booster - 12-24V DC - 10A max

Code : H10769 45€^{Incl. VAT}



Compatible with monochrome ribbons
Supply voltage: DC12V-24V
Maximum output load: 10A/CHx1
Output signal: MLI constant voltage
Maximum output power: 120W(12V) / 240W(24V)
Dimensions: 125 x 45 x H36 mm
Weight: 0.100 kg



TAPEBOOSTER

RGB signal amplifier
24V - 576 Watts maximum

Code : H9865 29€^{Incl. VAT}



Compatible with 3-colour and monochrome ribbons
Supply voltage: DC 24V
Maximum output load: 3x8A
Output signal: MLI constant voltage
Maximum output power: 576W(24V)
Dimensions: 107 x 65 x 24 mm
Weight: 0.5 kg



TAPEBOOSTER-RGBW

4 channel booster - 5-24V DC
3 x 3A + 1 x 9A max.

Code : H10770 79€^{Incl. VAT}



Compatible with 4-colour, 3-colour and monochrome ribbons
Supply voltage : DC5V-DC24 V
Maximum output load:
- RGB : 3Ax3CH
- W : 9Ax1CH
Output signal: MLI constant voltage
Maximum output power:
- RGB : 72Wx3CH
- W : 216W(24V)
Dimensions: 176 x 46 x 30 mm
Weight: 0.145 kg



MICRO LED MANAGER Mk2

LED DMX Power supply 50W 24V cv

Code : B04950 99€^{Incl. VAT}



Compatible with 3-colour and monochrome ribbons
Integrated power supply: DC24 V
Maximum output power:
- RGB : 16Wx3CH total 50W
Integrated switch controller for:
Master/Slave, 16 Colours, Musical, programs.
4-channel DMX operation
Connection for wall controller LED WALL DIMMER and ON / OFF switch
Power supply: AC230V - 50 Hz
Dimensions: 332 x 70 x 40 mm
Weight: 0.950 kg



MINI LED MANAGER Mk3

LED DMX Power supply 100W 24V cv

Code : B04949 144,90€^{Incl. VAT}



Compatible with 3-colour and monochrome ribbons
Integrated power supply: DC24 V
Maximum output power:
- RGB : 33Wx3CH total 100W
Integrated switch controller for:
Master/Slave, 16 Colours, Musical, programs.
4-channel DMX operation
Connection for wall controller LED WALL DIMMER and ON / OFF switch
Power supply: AC230V - 50 Hz
Dimensions: 356 x 132 x 43 mm
Weight: 1.9 kg



LED RF-CONTROL DIM

1 channel single colour LED controller

Code : B05396 32,90€^{Incl. VAT}



Compatible with monochrome ribbons
Power: DC12-24 V
Maximum output power:
- 240 W under 12 V
- 480 W under 24 V
HF remote control (433.92 MHz) integrated for:
M/A, stop 30s, dimmer, levels, night light
RJ45 connection for Master/Slave synchronization
Dimensions: 90 x 90 x 24 mm
Weight: 0.250 kg



LED RF-CONTROL RGB

3-channel RGB controller

Code : B05397 32,90€^{Incl. VAT}



Compatible with tricolour ribbons
Power: DC12-24 V
Maximum output power:
- 240 W under 12 V
- 480 W under 24 V
HF remote control (433.92 MHz) integrated for:
M/A, stop 30s, dimmer, levels, night light
RJ45 connection for Master/Slave synchronization
Dimensions: 90 x 90 x 24 mm
Weight: 0.250 kg



POWER SUPPLIES

A



POW2411P
Waterproof power supply for ribbon
24V DC - 30 Watts maximum

Code : H9881 19€^{Incl. VAT}

Contest 

B



EIP 060V0240LS
Switching power supply - 24Vdc/60W

Code : B05390 32,90€^{Incl. VAT}

JBSYSTEMS

C



POW242
Power supply
24V - 50 Watts max - IP20

Code : H9807 35€^{Incl. VAT}

Contest 

D



POW244IP2
Power supply 24VDC 4.15A
100W max - IP65 - 2 outputs

Code : H10362 75€^{Incl. VAT}

Contest 

E



LRS-100-24
Power supply MeanWell 24v DC
100W, IP20 - 2 exits

Code : H10581 49€^{Incl. VAT}

Contest 

F



DR120-24
Power supply MW
120W Stabilized, for DIN rail

Code : H9926 139€^{Incl. VAT}

Contest 

G



ESE 150-24S
Switching power supply - 24Vdc/150W

Code : B05398 49€^{Incl. VAT}

JBSYSTEMS

H



POW246IP2
Power supply 24VDC 6.25A
150W max - IP65 - 2 outputs

Code : H10316 89€^{Incl. VAT}

Contest 

I



RSP-200-24
Power supply MeanWell 24v DC
200W, IP20 - 3 outputs

Code : H10582 119€^{Incl. VAT}

Contest 

J



DRP240-24
Power supply MW
240W Stabilized, for DIN rail

Code : H9927 159€^{Incl. VAT}

Contest 

K



RSP-320-24
Power supply MeanWell 24v DC
320W, IP20 - 3 outputs - vented

Code : H10583 139€^{Incl. VAT}

Contest 

L



DRP480-24
Power supply MW
480W Stabilized, for DIN rail

Code : H11150 329€^{Incl. VAT}

Contest 

M



LRS-50-5
Power supply MeanWell 5v DC
50W,IP20

Code : H10599 39€^{Incl. VAT}

Contest 

N



LRS-100-5
Power supply MeanWell 5v DC
100W,IP20 - 2 outputs

Code : H10600 49€^{Incl. VAT}

Contest 

O



LRS-200-5
Power supply MeanWell 5v DC
200W,IP20 - 3 outputs

Code : H10971 79€^{Incl. VAT}

Contest 

	Reference	Code	Output voltage	Intensity	Power	Number of outputs	Format	IP	Dimensions
A	POW241IP	H9881	24V	1 A	30 W	1	-	IP65	218 x 30 x 22
B	EIP 060V0240LS	B05390		2.5 A	60W	1	-	IP20	157 x 54 x 36
C	POW242	H9807		2.1 A	50 W	1	-	IP20	125 x 52 x 36
D	POW244IP2	H10362		4 A	100 W	2	-	IP65	240 x 68 x 57
E	LRS-100-24	H10581		4.5A	100 W	2	To be integrated	IP20	129 x 97 x 30
F	DR120-24	H9926		5 A	120 W	2	Rail	IP20	65.5 x 125.2 x 100
G	ESE 150-24S	B05398		6.25 A	150 W	2	To be integrated	IP20	159 x 97 x 30
H	POW246IP2	10316		6.5 A	150 W	2	-	IP65	240 x 68 x 57
I	RSP-200-24	10582		8.4 A	200 W	3	To be integrated	IP20	215 x 115 x 30
J	DRP-240-24	9927		10 A	240 W	2	Rail	IP20	125.5 x 125.2 x 100
K	RSP-320-24	10583		13.4 A	320 W	3	To be integrated	IP20	215 x 115 x 3
L	DRP-480-24	9928		20 A	480 W	2	Rail	IP20	85,5 x 125,2 x 128,5
M	LRS-50-5	H10599		5V	10 A	50 W	1	To be integrated	IP20
N	LRS-100-5	H10600	20 A		100 W	1	To be integrated	IP20	129 x 97 x 30
O	LRS-200-5	H10971	40A		200W	3	To be integrated	IP20	215 x 115 x 30



HOW TO CHOOSE A POWER SUPPLY?

What is the consumption of a ribbon in W and which power supply should I choose?

Example:

9m of RGB ribbon with 60 LEDs/m 14.4 W/m in 24 V (COLOURTAPE6065)

Consumption of a length L of ribbon (in W) = length (m) x power/meter (w/m)

The ribbon will consume 14.4 x 9 = 129.6 W

Power supply choice:

An additional 10% of power must be added to the power supply.

In the same example:

129.6+10%= 142.56 W

POW246IP2 which is 150W



ACCESSORIES FOR RIBBONS

ALUMINIUM PROFILES

NEW

TAPEprofil-E Aluminium profile 11x20mm length 2m

Code : H11059
16€ Incl. VAT

Contest 



TAPEprofil-A Flush-mounted aluminium profile 8.5 x 23 mm Length 2m

Code : H10619
19€ Incl. VAT

Contest 

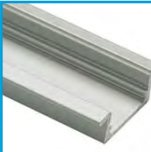
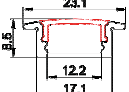
TAPEprofil-B Aluminium profile 15 x 17 mm Length 2m

Code : H10620
22€ Incl. VAT

Contest 



ALU-CORNER-15MM (2M) Corner profile

Code : B05376
24,90€ Incl. VAT



JBSYSTEMS 



TAPEprofil-C 19 x 19 mm aluminium profile 45° Length 2m

Code : H10621
29€ Incl. VAT

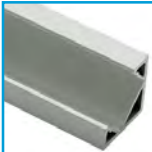
Contest 

ALU-RECESS-15MM (2M) High profile to be recessed

Code : B05371
29,90€ Incl. VAT

JBSYSTEMS 



ALU-SURFACE-7MM (2M) Low Profile

Code : B05372
25,90€ Incl. VAT

JBSYSTEMS 



ALU-SURFACE-15MM (2M) High Profile

Code : B05374
30,90€ Incl. VAT



JBSYSTEMS 



TAPEprofil-D Aluminium profile double width 15 x 24 mm Length 2m

Code : H10622
38€ Incl. VAT

Contest 

NEW

TAPEprofil-F Aluminium profile stair nosing length 2m

Code : H11065
39€ Incl. VAT

Contest 





CLIP FOR PROFILE

TAPEclip-B Fastening clip for profile B

Code : H10633
1,70€ Incl. VAT

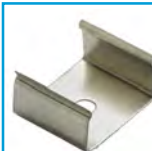
Contest 



TAPEclip-C Fastening clip for C-profile

Code : H10634
0,80€ Incl. VAT

Contest 

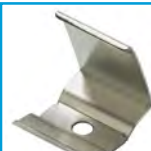

TAPEclip-D Fastening clip for profile D

Code : H10635
1,10€ Incl. VAT

Contest 

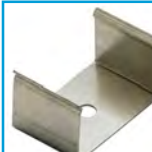

NEW

TAPEclips-E Fastening clips for E-Profile

Code : H11064
1,50€ Incl. VAT

Contest 





DIFFUSERS

	<p>TAPEcov-1 Crystal Diffuser for A,B,C Profiles Length 2m</p> <p>Code : H10623</p> <p>14€^{Incl. VAT}</p> <p>Contest </p>
-----------------------------------------------------------------------------------	---------------------------------------------------------------------------------------------------------------------------------------------------------------------------------------------------------------------------------------

	<p>TAPEcov-2 Frost diffuser for profiles A,B,C Length 2m</p> <p>Code : H10624</p> <p>14€^{Incl. VAT}</p> <p>Contest </p>
-----------------------------------------------------------------------------------	---------------------------------------------------------------------------------------------------------------------------------------------------------------------------------------------------------------------------------------

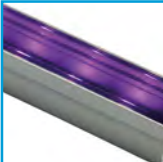
	<p>TAPEcov-3 Milk diffuser for A,B,C profiles Length 2m</p> <p>Code : H10625</p> <p>14€^{Incl. VAT}</p> <p>Contest </p>
-----------------------------------------------------------------------------------	------------------------------------------------------------------------------------------------------------------------------------------------------------------------------------------------------------------------------------

	<p>TAPEcov-4 Crystal Diffuser for D-Profiles Length 2m</p> <p>Code : H10626</p> <p>19€^{Incl. VAT}</p> <p>Contest </p>
-----------------------------------------------------------------------------------	-------------------------------------------------------------------------------------------------------------------------------------------------------------------------------------------------------------------------------------

	<p>TAPEcov-5 Frost diffuser for D-Profiles Length 2m</p> <p>Code : H10627</p> <p>19€^{Incl. VAT}</p> <p>Contest </p>
-----------------------------------------------------------------------------------	---------------------------------------------------------------------------------------------------------------------------------------------------------------------------------------------------------------------------------

	<p>TAPEcov-6 Milk Diffuser for D" Profiles Length 2m</p> <p>Code : H10628</p> <p>19€^{Incl. VAT}</p> <p>Contest </p>
-----------------------------------------------------------------------------------	-----------------------------------------------------------------------------------------------------------------------------------------------------------------------------------------------------------------------------------

NEW 	<p>TAPEcov-7 Diffuser Milk for TAPEprofil-E Length 2m</p> <p>Code : H11060</p> <p>12€^{Incl. VAT}</p> <p>Contest </p>
--------------------------------------------------------------------------------------------------	-----------------------------------------------------------------------------------------------------------------------------------------------------------------------------------------------------------------------------------



NEW 	<p>TAPEcov-8 Square diffuser Milk for TAPEprofil-E Length 2m</p> <p>Code : H11062</p> <p>13€^{Incl. VAT}</p> <p>Contest </p>
--------------------------------------------------------------------------------------------------	------------------------------------------------------------------------------------------------------------------------------------------------------------------------------------------------------------------------------------------------



NEW 	<p>TAPEcov-9 Diffuser Dome Milk TAPEprofil-F Length 2m</p> <p>Code : H11057</p> <p>12€^{Incl. VAT}</p> <p>Contest </p>
---------------------------------------------------------------------------------------------------	-------------------------------------------------------------------------------------------------------------------------------------------------------------------------------------------------------------------------------------

TERMINATION COVER

	<p>TAPEcaps-A Termination cover for profile A</p> <p>Code : H10629</p> <p>0,80€^{Incl. VAT}</p> <p>Contest </p>
-------------------------------------------------------------------------------------	--------------------------------------------------------------------------------------------------------------------------------------------------------------------------------------------------------------------------

	<p>TAPEcaps-B Termination cover for profile B</p> <p>Code : H10630</p> <p>0,80€^{Incl. VAT}</p> <p>Contest </p>
-------------------------------------------------------------------------------------	----------------------------------------------------------------------------------------------------------------------------------------------------------------------------------------------------------------------------

	<p>TAPEcaps-C Termination cover for C-profile</p> <p>Code : H10631</p> <p>0,80€^{Incl. VAT}</p> <p>Contest </p>
-------------------------------------------------------------------------------------	--------------------------------------------------------------------------------------------------------------------------------------------------------------------------------------------------------------------------

	<p>TAPEcaps-D Termination cover for D-profile</p> <p>Code : H10632</p> <p>0,80€^{Incl. VAT}</p> <p>Contest </p>
-------------------------------------------------------------------------------------	----------------------------------------------------------------------------------------------------------------------------------------------------------------------------------------------------------------------------

NEW 	<p>TAPEcaps-E7 TAPEprofil-E and TAPEcov-7 termination cover</p> <p>Code : H11061</p> <p>1€^{Incl. VAT}</p> <p>Contest </p>
---------------------------------------------------------------------------------------------------	-----------------------------------------------------------------------------------------------------------------------------------------------------------------------------------------------------------------------------------------

NEW 	<p>TAPEcaps-E8 TAPEprofil-E and TAPEcov-8 termination cover</p> <p>Code : H11063</p> <p>1€^{Incl. VAT}</p> <p>Contest </p>
---------------------------------------------------------------------------------------------------	-------------------------------------------------------------------------------------------------------------------------------------------------------------------------------------------------------------------------------------------

NEW 	<p>TAPEcapsl-F Termination cover left for TAPE- profil-F</p> <p>Code : H11149</p> <p>2,50€^{Incl. VAT}</p> <p>Contest </p>
---------------------------------------------------------------------------------------------------	-----------------------------------------------------------------------------------------------------------------------------------------------------------------------------------------------------------------------------------------

NEW 	<p>TAPEcapsr-F Termination cover right for TAPEprofil-F</p> <p>Code : H11058</p> <p>2,50€^{Incl. VAT}</p> <p>Contest </p>
---------------------------------------------------------------------------------------------------	------------------------------------------------------------------------------------------------------------------------------------------------------------------------------------------------------------------------------------------



ACCESSORIES FOR RIBBONS



TCO-2
T connector for 10 mm monochrome ribbons

Code : H10549 0,60€Incl. VAT



TCO-3
T connector for 2-colour 10 mm ribbons

Code : H10552 1€Incl. VAT



TCO-4
T connector for 10 mm 3-colour ribbons

Code : H10555 1€Incl. VAT



TCO-5
T connector for 12 mm 4-colour ribbons

Code : H10558 1,20€Incl. VAT



XCO-2
X connector for 10 mm monochrome ribbons

Code : H10550 1€Incl. VAT

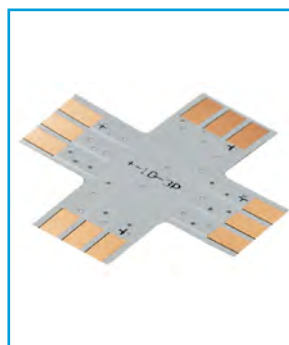

XCO-3
X connector for 2-colour ribbons 10 mm

Code : H10553 1,20€Incl. VAT

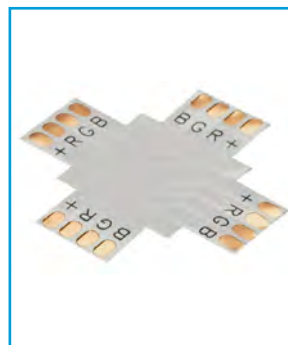

XCO-4
X connector for 10 mm 3-colour ribbons

Code : H10556 1,20€Incl. VAT

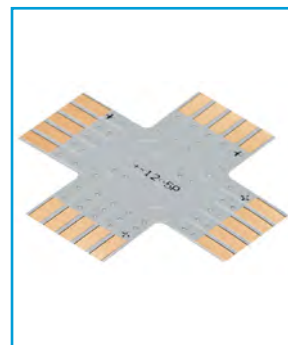

XCO-5
X connector for 12 mm 4-colour ribbons

Code : H10559 1,20€Incl. VAT



LCO-2
L connector for 10 mm monochrome ribbons

Code : H10548 0,80€Incl. VAT



LCO-3
L connector for 2-colour ribbons 10 mm

Code : H10551 0,80€Incl. VAT



LCO-4
L connector for 10 mm 3-colour ribbons

Code : H10554 0,80€Incl. VAT

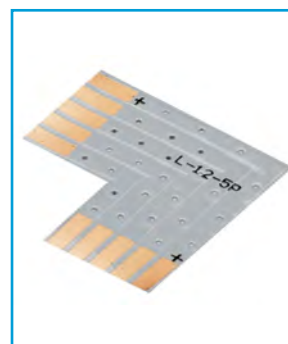

LCO-5
L connector for 12 mm 4-colour ribbons

Code : H10557 1€Incl. VAT





A	H10637	PILOTBOX - Recessed square box 47 mm white	CONTEST®	9€ ^{Incl. VAT}
B	H10638	PILOTSCREW - Screw steel size M3.5x20 - 1 piece (2 are needed by PILOTBOX)	CONTEST®	0,50€ ^{Incl. VAT}
C	H10544	ADF1050 - Double sided adhesive width 10 mm - roll of 50 m - 3M 300LSE	CONTEST®	42€ ^{Incl. VAT}
D	H10545	ADF1250 - Double sided adhesive width 12 mm - roll of 50 m - 3M 300LSE	CONTEST®	49€ ^{Incl. VAT}
E	H10546	FLATCABLE-4 Flat cable 4 x 0.326mm ² N/G/R/B - 10m	CONTEST®	25€ ^{Incl. VAT}
F	H10547	FLATCABLE-5 - Flat cable 5 x 0,326mm ² N/G/R/B/Y- 10m	CONTEST®	29€ ^{Incl. VAT}
G	H9887	TAPELINK20 - 4-wire cords with F/F-IP20 connectors	CONTEST®	1,40€ ^{Incl. VAT}
H	H9888	TAPECON4FF - 4-pin connector F / F-IP20 pack of 20	CONTEST®	1€ ^{Incl. VAT}
I	H9883	TAPEFIX65 - Set of 15 bridges, 5 endcaps, 1 Silicone Tube	CONTEST®	4,80€ ^{Incl. VAT}
J	H9884	TAPELINK61 - 4-wire cords with M/F-IP61 connectors - black	CONTEST®	2,90€ ^{Incl. VAT}
K	H9885	TAPELINK65 - Connect 4-wire cords. M/F-IP65 - transparent	CONTEST®	5,60€ ^{Incl. VAT}
L	H9886	TAPELINK68 - 4-wire cords M/F-IP68 connectors - white	CONTEST®	3,50€ ^{Incl. VAT}
M	H9882	TAPEFIX68 - Set of 15 bridges, 5 endcaps, 1 Silicone Tube	CONTEST®	4,80€ ^{Incl. VAT}
N	H9808	RGBB-100 - 4-wire electric cable for 3-colour ribbons of 50 meter	CONTEST®	119€ ^{Incl. VAT}



Ribbon type



FLEX LED PIXEL

Monochrome/UV/Blue

W/WW

RGB

RGBW



PILOTdrive-1	H10560	✓	-	-	-	-
PILOTdrive-2	H10561	-	✓	-	-	-
PILOTdrive-3 MKII	H10990	-	-	✓	-	-
PILOTdrive-4	H10563	-	-	-	✓	-
TAPEDIMMER	H9866	✓	-	-	-	-
LED 1CH DIM WALL	B05392	✓	-	-	-	-
TAPEDRIVER-1	H10573	✓	-	-	-	-
LED DMX-CONTROL SCREW MK2	B05394	-	-	✓	-	-
TAPEDRIVER-3	H10574	✓	✓	✓	-	-
TAPEDRIVER-4	H10575	✓	✓	✓	✓	-
TAPEDRIVER-12	H10576	✓	✓	✓	✓	-
MICRO LED MANAGER Mk2	B04936	-	-	✓	-	-
MINI LED MANAGER Mk3	B04949	-	-	✓	-	-
TAPEDRIVER-RF3	H10577	✓	-	✓	-	-
TAPEDRIVERTOUCH-RF3	H10578	-	-	✓	-	-
TAPEDRIVER-RF4	H10579	-	-	-	✓	-
TAPEDRIVER-WIFI4	H10580	✓	✓	✓	✓	-
LED RF-CONTROL DIM	B05396	✓	-	-	-	-
LED RF-CONTROL RGB	B05397	-	-	✓	-	-
TAPELIVE4	H10572	✓	✓	✓	✓	-
DOORSENSOR	H11036	✓	-	-	-	-
SmartCTL-BTM	H11038	-	-	-	-	✓
SmartCTL-BTL	H11037	-	-	-	-	✓
SMART-CTL800	H10949	-	-	-	-	✓



Product	TAPEDRIVER-RF3 10577	TAPEDRIVERTOUCH- -RF3 10578	TAPEDRIVER-RF4 10579	TAPEDRIVER-WiFi4 10580	TAPELIVE4 10572	TAPEDRIVER1 10573	TAPEDRIVER3 10574	TAPEDRIVER4 10575	TAPEDRIVER12 10576	MINI LED MANAGER MK3 B04949	MICRO LED MANAGER MK2 B06950
REMOTERF-8W H10569	✓	-	-	-	-	-	-	-	-	-	-
REMOTERF-10RGB H10570	✓	✓	-	-	-	-	-	-	-	-	-
REMOTERF-8RGBW H10571	-	-	✓	-	-	-	-	-	-	-	-
PILOTctl-1 H10564	-	-	-	✓	-	✓	-	-	-	-	-
PILOTctl-2 H10565	-	-	-	✓	-	-	✓	-	-	-	-
PILOTctl-3 H10566	-	-	-	✓	-	-	✓	-	-	-	-
PILOTctl-4 H10567	-	-	-	✓	-	-	-	✓	-	-	-
PILOTctl-16 H10568	-	-	-	✓	-	-	-	✓	✓	-	-
Téléphone/Tablette	-	-	-	-	✓	-	-	-	-	-	-
TAPELIVE4 H10572	-	-	-	✓	-	-	-	-	-	-	-
Controleur DMX	-	-	-	-	-	✓	✓	✓	✓	-	-
LED WALL DIMMER B04936	-	-	-	-	-	-	-	-	-	✓	✓
LEDCON-02 MK2 B04660	-	-	-	-	-	-	-	-	-	✓	✓



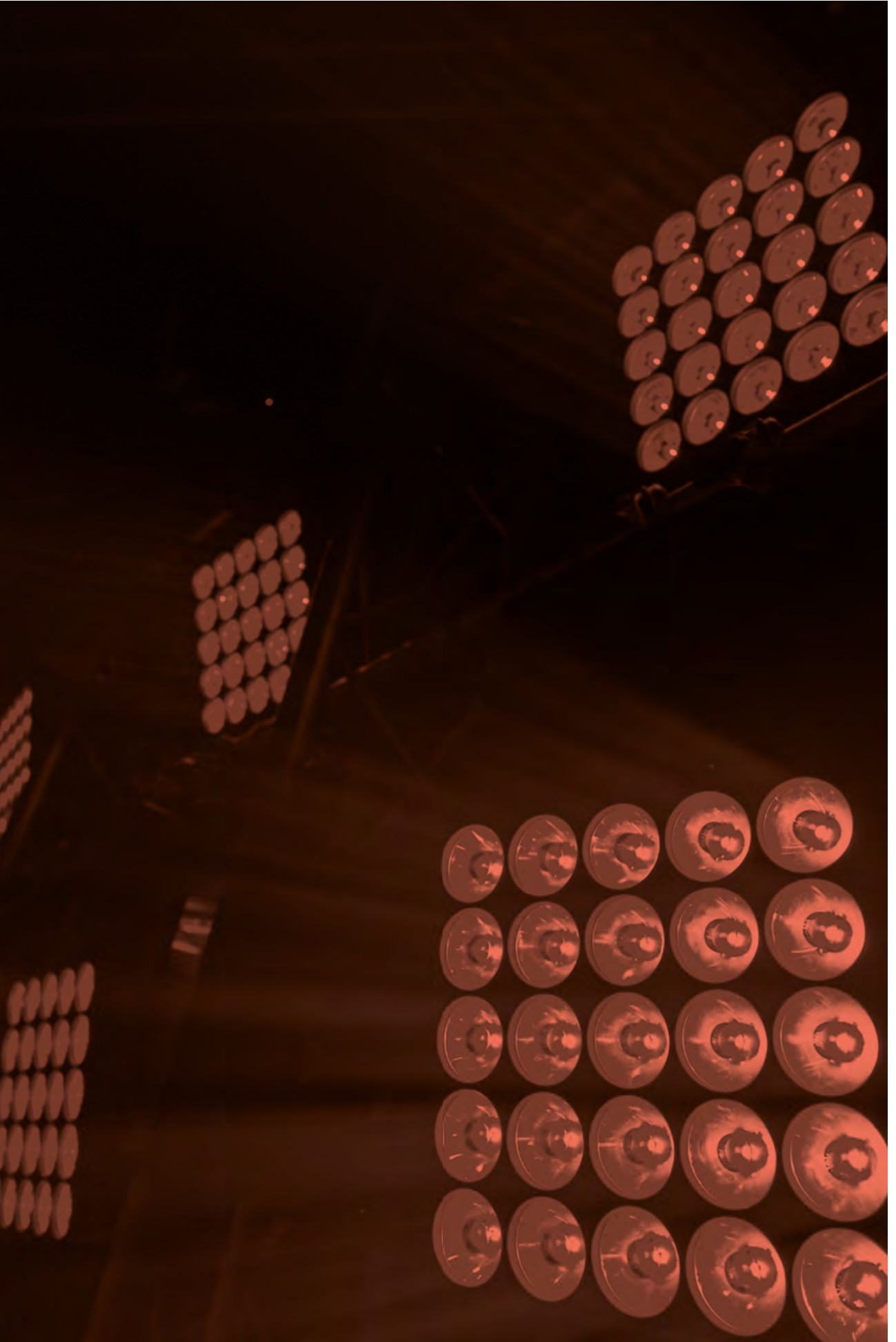

LIGHTING

OUTDOOR SPOTLIGHTS
AMBIENT SPOTLIGHTS
BATTERY PORTABLE PROJECTORS
SCENOGRAPHY PROJECTORS
FLAT PROJECTORS
PAR PROJECTORS
TRADITIONAL PROJECTORS
BLINDERS & PROJECTORS
FLOOD PROJECTORS
MOVING HEAD
ANIMATION EFFECTS
LASERS
STROBOSCOPES
MIRROR BALLS
CHROMATEQ®
SWEETLIGHT
BT-NODE
DMX CONTROLLERS
HOIST SYSTEM CONTROLLERS



OUTDOOR PROJECTORS



NEW



WW IP65 130W WW 15° 35°

BT-SUNRAY 130R
COB projector (3000K, CRI→97) with amber drift effect. IP65

Code : B05525 629€^{Incl. VAT}



Powerful 130W white COB projector (3000K) with amber drift effect, behaves exactly like a halogen blinder!
Waterproof IP65 rating
Led strobe
Preprogrammed amber drift effect and/ or separate control for white/amber!
Tunable CCT: from 1700K to 3000K
Very high CRI-factor (CRI: 97 – R9: 89) for perfect color rendering.
4 DMX-modes
Flicker-free
Very high 16kHz LED refresh rate
Different accessories included:
2 compound eye lenses with beam angles: 15° and 35°
1 blinder glass (authentic blinder look)
1 gel frame (install optional CTO / CTB / COLOR filters)
1 glare shield (anti-glare and better beam)

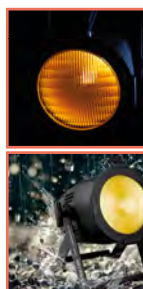

NEW



BT-BARN 4
Optional barndoor designed for BT-COLORAY MULTI and BT-SUNRAY 130R

Code : B05527 47.90€^{Incl. VAT}



This 4-leaf barndoor helps delimiting the beam in certain directions.
Designed for use with: BT-COLORAY MULTI
BT-SUNRAY 130R
Can be used in combination with the lenses or color filter frame.
Can be used outdoor.
This 4-leaf barndoor helps delimiting the beam in certain directions.
Designed for use with: BT-COLORAY MULTI & BT-SUNRAY 130R

NEW



R G B IP65 120W RGBW 15° 35°

BT-COLORAY MULTI
IP65,120W RGBW LED projector

Code : B05524 569€^{Incl. VAT}



Powerful 120W RGBW
IP65 waterproof housing
2 lenses with beam angles: 15° and 35°.
1 Anti-glare cylinder (anti-glare and better beam)
Flicker-free
3 DMX modes: 4, 6 and 7 channels.
RDM functionality to facilitate remote configuration
OLED display with backlit touch buttons
2 lenses with beam angles: 15° and 35°.
1 Anti-glare cylinder (anti-glare and better beam)





BT-ColoRay 18FCR
LED proj. 144W RGBW 20° (IP-POWER)

Code : B05512 389€^{Incl. VAT}

Optics: 8x18W RGBW LED
Opening angle: 20°
Integrated control unit with LCD display with drop-down menu
DMX IN and OUT with 5-pin XLR plugs with waterproof plug
POWER IN/OUT with original NEUTRIK PowerCon® TRUE1 connectors
Power supply: 100-240V/50-60Hz
Power consumption: 129 W
Waterproofing level: IP65
Waterproof fan
Depressurisation valve with waterproof membrane
Finish: cast aluminium painted black
Dimensions : 305 x 273 x 192 mm
Weight: 5,28 kg



BT-ColoRay 120R
LED proj. 120W RGBW COB 13° RENTAL (IP-POWER)

Code : B05509 459€^{Incl. VAT}

Optics: 1x 120W RGBW COB LED
Opening angle: 15°
Integrated control unit with LCD display with drop-down menu
DMX IN and OUT with 5-pin XLR plugs with waterproof plug
POWER IN/OUT with original NEUTRIK PowerCon® TRUE1 connectors
Power supply: 100-240V/50-60Hz
Power consumption: 129 W
Waterproofing level: IP65
Waterproof fan
Depressurisation valve with waterproof membrane
Finish: cast aluminium painted black
Dimensions: 304 x 188 x 272 mm
Weight: 4.8 kg



BT-ColoRay 60R
LED proj. 60W RGBW 15° RENTAL COB (IP-POWER)

Code : B05510 329€^{Incl. VAT}

Optics: 1x 60W RGBW COB LED
Opening angle: 15°
Integrated control unit with LCD display with drop-down menu
DMX IN and OUT with 5-pin XLR plugs with waterproof plug
POWER IN/OUT with original NEUTRIK PowerCon® TRUE1 connectors
Power supply: 100-240V/50-60Hz
Power consumption: 70 W
Waterproofing level: IP65
Waterproof fan
Depressurisation valve with waterproof membrane
Finish: cast aluminium painted black
Dimensions: 304 x 188 x 272 mm
Weight: 4.8 kg



PROJECTOR CASE 3
Can contain 6 projectors (BT-Coloray series, Stage Beamer, Pro Beamer, BT-Smartzoom)

Code : B03280 669€^{Incl. VAT}

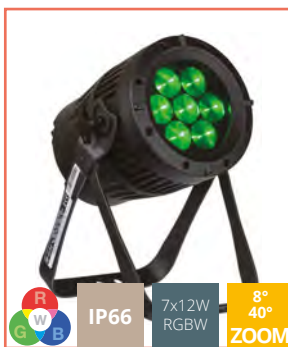

PRO BEAMER ZOOM - RENTAL
8° - 40° motorised zoom

Code : B04399 619€^{Incl. VAT}

Optics: 7x12W RGBW LEDs
Two zones (outer ring + centre)
Zoom opening angle: 8° to 40°
Integrated control unit with display with drop-down menu
SEETRONIC® DMX IN and OUT with 3-pin XLR plugs with waterproof plug
SEETRONIC® POWER IN/OUT
3-pole plugs with waterproof plug
Power supply: 100-240V/50-60Hz
Power consumption: 128W
Waterproofing level: IP66
Natural convection cooling
Depressurisation valve with waterproof membrane
Finish: cast aluminium painted black
Dimensions: 355 x 191 x 236 mm
Weight: 7.3 kg



STAGE BEAMER FC - OUTDOOR
14x5W RGBW 14° - IP65

Code : B05511 399€^{Incl. VAT}

Optics: 14x5W RGBW LEDs
Opening angle: 14°
Integrated control unit with display with drop-down menu
Waterproof wiring for power supply inputs/outputs and DMX inputs/outputs
Power supply: 100-240V/50-60Hz
Power consumption: 65W
Waterproofing level: IP65
Natural convection cooling
Finish: cast aluminium painted black
Dimensions: 245 x 205 x 245 mm
Weight: 4.96 kg



BARN-STAGE BEAMER
Stage Beamer barndoor

Code : B04342 59€^{Incl. VAT}



Compatible IP cables	Product concerned
B01425 - True1/XLR-3P 1,5M	BT-Sunray 130R BT-COLORAY MULTI BT-COLORAY 18FCR BT-COLORAY 120R BT-COLORAY 60R PRO BEAMER ZOOM-RENTAL
B01426 - True1/XLR-3P 3M	
B01427 - True1/XLR-3P 5M	
B04911 - POWERLINK CABLE 1,5 M	Stage Beamer FC-OUTDOOR
B04913 - POWERLINK CABLE 10M	
B04324 - POWERLINK CABLE 5M	
B04908 - SIGNAL LINK CABLE 1,5M	
B04904 - SIGNAL LINK CABLE 10M	
B04903 - SIGNAL LINK CABLE 5M	
B05157 - LDP-Powercable 2M	
B05158 - LDP-Powercable 5M	



OUTDOOR PROJECTORS

Enhance your buildings with all the power of the CONTEST® IPANELs. Discover the benefit of mixing power with the opening angle.





R
G
B
W

IP65 **24x10W** **31°**
RGBW

IPANEL24x10QC
Projector with 24x10W QC IP65 LEDs

Code : H10794 899€Incl. VAT

Contest® 



FLY4IPANEL
Flight case for 4 IPANEL24x10QC

Code : H10866 549€Incl. VAT

Contest® 



IPANEL24x10QC-BARN
Leaves for IPANEL24x10QC

Code : H10889 99€Incl. VAT

Contest® 

Optics: 24x10W RGBW 4-Zone LEDs
 Opening angle: 31°
 Integrated control unit with display with drop-down menu
 DMX mode from 2 to 20 channels, master/slave, manual mode, presets and integrated show, choice of dimmer curves.
 Waterproof wiring for power supply inputs/outputs and DMX inputs/outputs
 Power supply: 100-240V/50-60Hz
 Power consumption: 240 W
 Waterproofing level: IP65
 Natural convection cooling
 Finish: cast aluminium painted black
 Dimensions: 582 x 270 x 178 mm
 Weight: 15 kg





IP65 **150W** **60°**
COB

LDP-COBWASH 150TC
150W IP65 COB RVB LED

Code : B05170 779€^{Incl. VAT}



Optics: 1x150W RGB COB LED
Opening angle: 60°
Infrared remote control
Integrated control unit with display with drop-down menu
Waterproof wiring for power supply inputs/outputs and DMX inputs/outputs
Power supply: 100-240V/50-60Hz
Power consumption: 170W
Waterproofing level: IP65
Natural convection cooling
Finish: cast aluminium, painted white
Barndoor included
Dimensions: 326 x 344 x 220 mm
Weight: 9.5 kg





IP65 **60W** **120°**
RGB

LDP-COBWASH 60TC
60W RGB IP65 COB LED projector

Code : B05171 379€^{Incl. VAT}

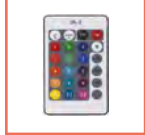

Optics: 1x 60W RGB COB LED
Opening angle: 120°
Infrared remote control
Integrated control unit with display with drop-down menu
Waterproof wiring for power supply inputs/outputs and DMX inputs/outputs
Power supply: 100-240V/50-60Hz
Power consumption: 66W
Waterproofing level: IP65
Natural convection cooling
Finish: cast aluminium, painted white
Barndoor option available
Dimensions: 223 x 202 x 122 mm
Weight: 8.2 kg

IP65 **15W** **10°**
RGB

EZ-SPOT15 OUTDOOR
15W RGBW LED projector

Code : B05131 119€^{Incl. VAT}



Optics: 1x15W RGBW LED
Opening angle: 10°
Infrared remote control IR-3
Power supply: 100-240V/50-60Hz
Power consumption: 27W
Waterproofing level: IP65
Natural convection cooling
Finish: cast aluminium painted black
Dimensions: 152 x 133 x 90 mm
Weight: 1.31 kg





WW **IP65** **15W** **10°**
WW

EZ-SPOT15 WW OUTDOOR
15W Warm White LED Projector

Code : B05141 119€^{Incl. VAT}



Optics: 1x15W WW LED
Opening angle: 10°
Infrared remote control IR-3
Power supply: 100-240V/50-60Hz
Power consumption: 27W
Waterproofing level: IP65
Natural convection cooling
Finish: cast aluminium painted black
Dimensions: 152 x 133 x 90 mm
Weight: 1.31 kg

LDP-COBWASH



OUTDOOR PROJECTORS



CW IP65 **50W** 5600K **120°**

LDP-COBWASH 50CW
50W white IP65 COB LED Projector

Code : B05177 349€^{Incl. VAT}



Optics: 1x 50W 5600K COB LED
Opening angle: 120°
Infrared remote control
Integrated control unit with display with drop-down menu
Waterproof wiring for power supply inputs/outputs and DMX inputs/outputs
Power supply: 100-240V/50-60Hz
Power consumption: 66W
Waterproofing level: IP65
Natural convection cooling
Finish: cast aluminium, painted white
Barndoor option available
Dimensions: 223 x 202 x 122 mm
Weight: 3.8 kg



WW IP65 **50W** 3200K **120°**

LDP-COBWASH 50WW
50W white COB IP65 LED projector

Code : B05178 349€^{Incl. VAT}



Optics: 1x 50W 3200K COB LED
Opening angle: 120°
Infrared remote control
Integrated control unit with display with drop-down menu
Waterproof wiring for power supply inputs/outputs and DMX inputs/outputs
Power supply: 100-240V/50-60Hz
Power consumption: 66W
Waterproofing level: IP65
Natural convection cooling
Finish: cast aluminium, painted white
Barndoor option available
Dimensions: 223 x 202 x 122 mm
Weight: 3.8 kg



LDP-COBWASH 50/60 BARNDOOR

Code : B05191 19.90€^{Incl. VAT}



Barndoor for:
LDP-COBWASH 50WW
LDP-COBWASH 50CW
LDP-COBWASH 60TC.



WW IP65 **80W** 3000K **120°**

LDP-FLOOD80-WW
IP65 projector with white LED

Code : B05117 199€^{Incl. VAT}



Optics: 1x80W 3000K COB LED
Opening angle: 120°
Power supply: 100-240V/50-60Hz
Power consumption: 80W
Waterproofing level: IP65
Natural convection cooling
Finish: cast aluminium, painted white
Dimensions: 288 x 360 x 110 mm
Weight: 6.5 kg



WW IP65 **50W** 3000K **120°**

LDP-FLOOD50-WW
IP65 projector with white LED

Code : B05116 139€^{Incl. VAT}



Optics: 1x50W 3000K COB LED
Opening angle: 120°
Power supply: 100-240V/50-60Hz
Power consumption: 50W
Waterproofing level: IP65
Natural convection cooling
Finish: cast aluminium, painted white
Dimensions: 290 x 236 x 150 mm
Weight: 3.52 kg



WW IP65 **30W** 3000K **100°**

LDP-FLOOD30-WW
IP65 projector with white LED

Code : B05115 109€^{Incl. VAT}



Optics: 1x30W 3000K COB LED
Opening angle: 100°
Power supply: 100-240V/50-60Hz
Power consumption: 30W
Waterproofing level: IP65
Natural convection cooling
Finish: cast aluminium, painted white
Dimensions: 250 x 185 x 126 mm
Weight: 2.3 kg



WW IP65 **10W** 3000K **120°**

LDP-FLOOD10-WW
IP65 projector with white LED

Code : B05114 29€^{Incl. VAT}



Optics: 1x10W Bridgelux® LED
Opening angle: 120°
Power supply: 100-240V/50-60Hz
Power consumption: 10W
Waterproofing level: IP65
Natural convection cooling
Finish: cast aluminium, painted white
Dimensions: 115 x 86 x 105 mm
Weight: 0.63 kg



LDP-JUNCTION IP68
Waterproof connection box for the LDP series and other outdoor DMX projectors.

Code : B05112 59€^{Incl. VAT}



Waterproof connection box for the LDP series and other outdoor DMX projectors. IP68 protection: Outdoor or even underground use.
Power supply compartment with 3 input outlets
DMX compartment with 4 input outlets
Very easy and fast internal connection
Ideal for the LDP series and any other combination of outdoor power/signal (PowerBeam lighting, LED Blaster, Powerbank, ...)

OUTDOOR PROJECTORS







LDP-COLORBAR 24FC
Bar with 24x4W RGBW 15° 2-section LEDs - 96cm - IP20

Code : B05146 499€^{Incl. VAT}









LDP-COLORBAR 12FC
Bar with 12x4W RGBW 15° 2-section LEDs - 48cm - IP20

Code : B05145 349€^{Incl. VAT}



Optics: 24x4W RGBW 2-section LEDs
Opening angle: 15°
Integrated control unit with display with drop-down menu
Power supply input/output on IEC plug
DMX input/output on XLR 3-pin plug
Power supply: 100-240V/50-60Hz
Power consumption: 85 W
Waterproofing level: IP65
Natural convection cooling
Dimensions: 960 x 56 x 114/135 mm
Weight: 5 kg

Optics: 12x4W RGBW 4-section LEDs
Opening angle: 15°
Integrated control unit with display with drop-down menu
Power supply input/output on IEC plug
DMX input/output on XLR 3-pin plug
Power supply: 100-240V/50-60Hz
Power consumption: 56 W
Waterproofing level: IP65
Natural convection cooling
Dimensions: 460 x 56 x 114/135 mm
Weight: 3.6 kg



Power Extenders and IP DMX cables



	Cables	Product concerned		
A	B04911 POWERLINK CABLE 1,5 M - Powerlink Cable 1,5M for Outdoor range	IPANEL, LDP-COBWASH150TC	Hilec®	17,90€ ^{Incl. VAT}
B	B04913 POWERLINK CABLE 10m - Powerlink Cable 10m, for Outdoor range	IPANEL, LDP-COBWASH150TC	Hilec®	65€ ^{Incl. VAT}
C	B04324 POWERLINK CABLE 5m - Powerlink Cable 5m, for Outdoor range	IPANEL, LDP-COBWASH150TC	Hilec®	35€ ^{Incl. VAT}
D	B04908 SIGNAL LINK CABLE 1,5M - Signal Link Cable 1,5m for Outdoor range	IPANEL, LDP-COBWASH150TC LDP-COBWASH60TC/50CW/50WW LDP-COLORBAR24FC/12FC	Hilec®	6,90€ ^{Incl. VAT}
E	B04904 SIGNAL LINK CABLE 10M - Signal Link Cable 10m, for Outdoor range	IPANEL, LDP-COBWASH150TC LDP-COBWASH60TC/50CW/50WW LDP-COLORBAR24FC/12FC	Hilec®	27€ ^{Incl. VAT}
F	B04903 SIGNAL LINK CABLE 5M - Signal Link Cable 5m, for Outdoor range	IPANEL, LDP-COBWASH150TC LDP-COBWASH60TC/50CW/50WW LDP-COLORBAR24FC/12FC	Hilec®	14,50€ ^{Incl. VAT}
G	B05157 LDP-Powercable 2M - Power cable L=2m	LDP-COBWASH60TC/50CW/50WW LDP-COLORBAR24FC/12FC	Hilec®	11€ ^{Incl. VAT}
H	B05158 LDP-Powercable 5M - Power cable L=5m	LDP-COBWASH60TC/50CW/50WW LDP-COLORBAR24FC/12FC	Hilec®	18€ ^{Incl. VAT}



AMBIENT PROJECTORS



			
-------------------------------------------------------------------------------------	-------------------------------------------------------------------------------------	-------------------------------------------------------------------------------------	-------------------------------------------------------------------------------------

LDP-COLORSTRIP 24FC
Bar with 24x4W RGBW 15° 4-section LEDs - 100cm - IP20

Code : B05144 329€^{Incl. VAT}



Optics: 24x4W RGBW 4-section LEDs
Opening angle: 15°
Integrated control unit with display with drop-down menu
Power supply input/output on IEC plug
DMX input/output on XLR 3-pin plug
Power supply: 100-240V/50-60Hz
Power consumption: 85 W
Waterproofing level: IP20
Natural convection cooling
Dimensions: 961 x 56 x 101/122 mm
Weight: 3.6 kg



			
-------------------------------------------------------------------------------------	-------------------------------------------------------------------------------------	-------------------------------------------------------------------------------------	-------------------------------------------------------------------------------------

LDP-COLORSTRIP 12FC
Bar with 12x4W RGBW 15° 2-section LEDs - 50cm - IP20

Code : B05143 269€^{Incl. VAT}



Optics: 12x4W RGBW 2-section LEDs
Opening angle: 15°
Integrated control unit with display with drop-down menu
Power supply input/output on IEC plug
DMX input/output on XLR 3-pin plug
Power supply: 100-240V/50-60Hz
Power consumption: 56 W
Waterproofing level: IP20
Natural convection cooling
Dimensions: 479 x 56 x 101/122 mm
Weight: 2.2 kg



AMBIENT PROJECTORS

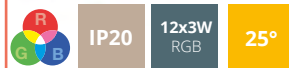

TRI4U

Light bar with 4x3W LED tricolour projectors

Code : H9955 229€^{Incl. VAT}



12x3W RGB LEDs located on 4 projectors
Opening angle: 25° per projector
Independent orientation per projector
Modes of operation:
- DMX
- Standalone
- Musical
- Master / slave
Specially designed hanging bracket with integrated hook for stand
Dimensions: 375 x 160 x 60 mm
Net weight: 2.5 Kg

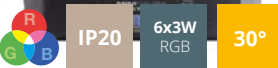

MINITRUSS-6TCb

Truss light projector with 6x3W TRI LEDs

Code : H10365 119€^{Incl. VAT}



Light source: 6x3W RGB LEDs
Opening angle: 30°
Modes of operation:
- DMX
- Standalone
- Musical
- Master / slave
Input/output on IEC plug
Power supply: 230V - 50Hz
Power consumption: 30W
Dimensions: 135 x 135 x 132 mm
Net weight: 1.4 kg



MINICUBE-6TCb

Compact projectors with 6x3W satin TRINoir LEDs

Code : H10147 99€^{Incl. VAT}



Light source: 6x3W RGB LEDs
Opening angle: 30°
Modes of operation:
- DMX
- Standalone
- Musical
- Master / slave
DMX input and output
Power supply: AC 100/240V - 50/60Hz
Power consumption: 30 W
Dimensions: 166 x 180 x 110 mm
Net weight: 1.35 kg



LED ROTOGOBO

60W gobos LED projector

Code : B04528 239€^{Incl. VAT}



A powerful 60W white LED motif projector
Low gobo temperature: no need for expensive thermo-resistant glass or metal gobos!
Usable with plastic gobos created by a simple laser printer!
Metal and glass gobos are of course always usable.
Easy adjustment by rotary knobs on the back of the projector:
Rotation speed control of the gobo
Dimmer switch to adjust light intensity
Beam angle: 18°
Dimensions: 236 x 234 x 206 mm
Weight: 3.4 kg



BATTERY PROJECTORS



IP65 **5x12W** **RGBWAUV** **25°**

IPair5x12Six
IP65 AirDMX battery projector

Code : H10411 399€^{Incl. VAT}



Optics: 5x12W RGBWAUV LEDs
Opening angle: 25°
AirDMX integrated transmitter / receiver
Compatible with AirBox-ER1
Integrated control unit with display with drop-down menu
Infrared remote control
DMX IN and OUT with 3-pin IP plugs
POWER IN/OUT with 4-pin IP plugs
Power supply: 100-240V/50-60Hz





FLY-IPairx6
Flight case for 6 IPair5x12Six

Code : H10464 349€^{Incl. VAT}

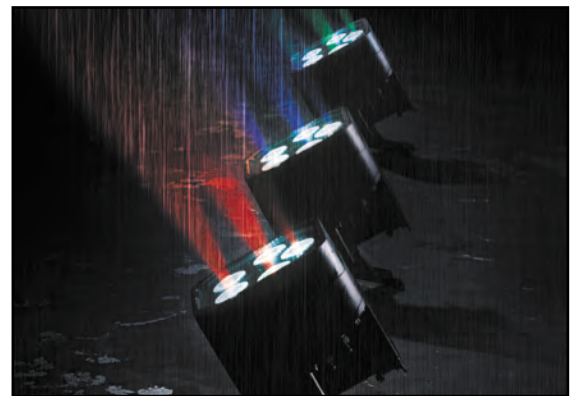

Power consumption: 65 W
12-cell 22.2V 4.4Ah lithium battery
Battery life: 6 hours in color changing mode - 4 hours in white [RGB]
Waterproofing level: IP65
Finish: cast aluminium painted black
Dimensions: 240 x 165 x 280 mm
Weight: 3.5 kg

A	H10465	FICIP-DMXm - DMX male waterproof plug for IPAir- IP68	12€ ^{Incl. VAT}
B	H10466	FICIP-DMXF - DMX female waterproof plug for IPAir- IP68	13€ ^{Incl. VAT}
C	H10467	FICIP-POWm - Male waterproof power plug for IPAir- IP68	10€ ^{Incl. VAT}
D	H10468	FICIP-POWf - Female waterproof power plug for IPAir- IP68	13€ ^{Incl. VAT}



IP65 **6x10W** **RGBWA** **25°**

BT-AKKULITE IP
Outdoor 6x10W RGBWA 5in1 LED projector + infrared remote control

Code : B05135 439€^{Incl. VAT}



Optics: 6x10W RGBWA LEDs
Opening angle: 22°
Wireless transmitter / receiver compatible with protocol W-DMX G4
Integrated control unit with display with drop-down menu
Infrared remote control
DMX IN / OUT with 3-pin XLR, POWER IN by Pro Con (Seetronic)
Waterproofing level: IP65
Power supply: 100-240V/50-60Hz Battery
Power consumption: 60 W
Dimensions: 180 x 150 x 198 mm
Weight: 4.5 kg



IP20 **6x10W** **RGBWA** **22°**

ACCU COLOR-WHITE
Battery powered LED projector, built around 6 RGBWA (10W) LEDs

Code : B05126 359€^{Incl. VAT}



Optics: 6x10W RGBWA LEDs
Opening angle: 22°
Wireless transmitter / receiver compatible with protocol W-DMX G4
Integrated control unit with display with drop-down menu
Infrared remote control
DMX IN and OUT with 3-pin XLR, POWER IN/OUT with Powercon
Power supply: 100-240V/50-60Hz Battery
Power consumption: 60 W
Finish: white delivered with a transparent plastic cover
Dimensions: 167 x 138 x 185 mm
Weight: 4.14 kg



IP20 **6x10W** **RGBWA** **22°**

ACCU COLOR-BLACK
Battery powered LED projector, built around 6 RGBWA (10W) LEDs

Code : B05128 359€^{Incl. VAT}



Optics: 6x10W RGBWA LEDs
Opening angle: 22°
Wireless transmitter / receiver compatible with protocol W-DMX G4
Integrated control unit with display with drop-down menu
Infrared remote control
DMX IN and OUT with 3-pin XLR, POWER IN/OUT with Powercon
Power supply: 100-240V/50-60Hz Battery
Power consumption: 60 W
Finish: black delivered with a transparent plastic cover
Dimensions: 167 x 138 x 185 mm
Weight: 4.14 kg



BATTERY PROJECTORS



CASE-3
Flight case for 6x BT-AKKULITE IP / ACCUCOLOR

Code : B03274 249€^{Incl. VAT}





ACCU DECOLITE
A battery powered LED projector, built around RGB + White 15W LED, with embedded wireless DMX

IP20 15W RGBW 30°

Code : B05127 149€^{Incl. VAT}





ACCU DECOLITE IP
A battery powered IP65 LED projector, built around 15W RGB + White LED, with embedded wireless DMX

IP65 15W RGBW 10°

Code : B05136 259€^{Incl. VAT}



CASE FOR 4xACCU DECOLITE
Flight case for 4x Accu Decolite

Code : B03279 179€^{Incl. VAT}



Optics: 1x15W RGBW LED
Opening angle: 10 to 25°
Wireless transmitter / receiver compatible with protocol W-DMX G4
Integrated control unit with display with drop-down menu
Infrared remote control
Power supply: 100-240V/50-60Hz Battery
Power consumption: 15 W
Dimensions: 168 x 138 x 62 mm
Weight: 1.61 kg

Optics: 1x15W RGBW LED
Opening angle: 10°
Wireless transmitter / receiver compatible with protocol W-DMX G4
Integrated control unit with display with drop-down menu
Infrared remote control
Power supply: 100-240V/50-60Hz
Power consumption: 15 W
Dimensions: 172 x 138 x 185 mm
Weight: 1.61 kg



ACCU DECOLITE IP BALL 25CM
Acrylic ball 25cm for ACCU DECOLITE IP - outdoor

Code : B05140 39€^{Incl. VAT}



ACCU DECOLITE IP TUBE 50CM
50cm acrylic tube for Accu Decolite IP

Code : B05137 19€^{Incl. VAT}



100CM ACCU DECOLITE IP TUBE
100cm acrylic tube for Accu Decolite IP

Code : B05138 29€^{Incl. VAT}



150CM ACCU DECOLITE IP TUBE
150cm acrylic tube for Accu Decolite IP

Code : B05139 39€^{Incl. VAT}



SCENOGRAPHY PROJECTORS



- ✓250 W LED, warm white 3200K with high CRI-factor (→92) for natural colors.✓Extremely powerful LED theater spot with electronic 10° ~ 50° zoom.
- ✓Color frame for use of color filters and 8-leaf barndoor included
- ✓Four dimmer curves: linear, square, inverse square, S-curve
- ✓Flicker free TV-recordings thanks to 3.6kHz LED refresh rate!



WW 250W 3200K 10° 50°

BT-THEATRE 250EZ

Powerful LED theatre projector with 10° - 50° electronic zoom

Code : B06016 879€^{Incl. VAT}



Optics: 1x250W 3200K COB LED
Opening zoom angle: 10° to 50°
Brightness of 1500 to 7735 Lux at 4m
Direct access to the dimmer and zoom
Integrated control unit with LCD display with drop-down menu
DMX IN/OUT with 3/5-pin XLR plugs
POWER IN/OUT with powerCON plugs
Power supply: 100-240V/50-60Hz
Power consumption: 275 W
heat sink and silent fan.
Finish: Black
Delivered with barndoor, filter frame
Dimensions: 458 x 336 x 399 mm
Weight: 8.9 kg



NEW WW 150W 3200K 10° 50°

BT-THEATRE 150EZ

Very powerful 150 Watt LED theater spot with electronic 10°-50° zoom.

Code : B06020 590€^{Incl. VAT}



10° - 50° zoom.
150watt LED, warm white 3200K
High CRI-factor (→97)
Color frame for use of color filters and 8-leaf barndoor included
Low noise cooling fan
DMX-controlled: 6 different channel
Flicker free
Manual dimming & zoom/focus control:
Four dimmer curves: linear, square, inverse square, S-curve
RDM-functionality for easy remote setup
3 & 5pin DMX in/outputs + Neutrik
PowerCON in/outputs for easy daisy chaining.
Weight: 6,2 kg



BT-THEATRE YOKE

Pole operated yoke for easy manual positioning of theatre projectors in TV-studios and theatres.

Code : B06021 149€^{Incl. VAT}



Replaces the standard bracket on BT-THEATRE 150EZ / 250EZ (eventual other projectors: see website)



TV-SPIGOT RECEIVER

easily connect to a standard clamp to equipment with 28mm TV-SPIGOT.

Code : B06603 29€^{Incl. VAT}



This special adapter makes it possible to easily connect a standard clamp to equipment with 28mm TV-SPIGOT
Perfect to fix our BT-THEATRE YOKE (code: B06021) to a standard clamp like our:
FAST CLAMP V2 (code: B02684)
ULTRA CLAMP (code: B06600)
Metal: AL6061-T6
SWL: 100kg
Color: black



R G B 250W 3200K 15° 50°

BT-THEATRE HD COLOR1

Theater spot 250W RGBAL + Hi-CRI white

Code : B06018 1150€^{Incl. VAT}



Mains Input: AC 100 - 240V, 50/60Hz
Power consumption: 240 Watts
Power connections: PowerCon input + PowerCon output
DMX connections: 3&5 pin-XLR male / female inputs + outputs
DMX modes: 4 modes (8CH + 10CH + 13CH + 19CH)
Lamp: LED, 200W RGBAL (Red, Green, Blue, Amber, Lime)
White color presets: 1800K 8000K
CRI color rendering: →90 (2700K - 4500K) - →85 (5600K - 8000K)
Beam Angle: electronic zoom 14° - 55°
IP-Rating: IP20
Cooling: heat pipe + forced low speed fan cooling
Weight: 7.6 kg



BT-THEATRE BARN2

Barndoor for BT-THEATRE HD1

Code : B06019 49€^{Incl. VAT}



PROJECTOR CASE 4

Case for 4x BT-Theatre 250EZ & 100 EC Mk2.

Code : B03285 649€^{Incl. VAT}



SCENOGRAPHY PROJECTORS



WW 100W 3200K 10° 50°

BT-THEATRE 100EC Mk2

LED with 10° to 50° manual zoom

Code : B06008 459€^{Incl. VAT}



Optics: 1x100W 3200K COB LED
manual zoom: 10° to 50°
7800 lux @ 2m (beam angle: 10°)
Integrated control unit with LCD display with drop-down menu
DMX IN/OUT with 3/5-pin XLR plugs
POWER IN/OUT with powerCON plugs
Power supply: 100-240V/50-60Hz
Power consumption: 125 W
Silent fan (31dB@1m)
Finish: Black
Delivered with barndoor, filter frame
Dimensions: 2788 x 305 x 336 mm
Weight: 6.2 kg



BARNDOOR FOR THEATERSPOT 1000

Barndoor for BT-THEATRE 100EC

Code : B02000 29€^{Incl. VAT}



SFX-PC20dimWb

Proj. 20W LED CP Warm White + Amber - Black

Code : H10900 139€^{Incl. VAT}



Optical
1 x 20W warm white + amber LED
Colour temperature: 3000°K
CRI 92
Light output of 600 Lux at 3m (39° opening)
Beam angle of 39° or 51°
Functions
Electronic dimmer
Power block or dimmer control possible
Connectors
POWER IN via 2P+E socket
Additional information
Power supply: 100-240V/50-60Hz
Power consumption: 20 W
Cooling system: convection-cooled, without forced ventilation
Finish: Black or white die-cast aluminium body
Dimensions: 186 x 141 x 211 mm
Weight : 2 kg



SFX-PC20dimWw

Proj. 20W LED CP Warm White + Amber - White

Code : H10902 139€^{Incl. VAT}



Optical
1 x 20W warm white + amber LED
Colour temperature: 3000°K
CRI 92
Light output of 600 Lux at 3m (39° opening)
Beam angle of 39° or 51°
Functions
Electronic dimmer
Power block or dimmer control possible
Connectors
POWER IN via 2P+E socket
Additional information
Power supply: 100-240V/50-60Hz
Power consumption: 20 W
Cooling system: convection-cooled, without forced ventilation
Finish: Black or white die-cast aluminium body
Dimensions: 186 x 141 x 211 mm
Weight : 2 kg



R G B 60W RGBW 10° 50°

BT-THEATRE 60FC

60W RGBW COB LED with 10° - 50° manual zoom.

Code : B06015 329€^{Incl. VAT}



Optics: 1x 60W RGBW COB LED
manual zoom: 10° to 50°
330 lux at 5m and 10°, 77 lux at 5m and 40°
Integrated control unit with LCD display with drop-down menu
DMX IN/OUT with 3-pin XLR plugs
POWER IN with 1 m cord with plug
Power supply: 100-240V/50-60Hz
Power consumption: 62 W
Dissipation fan
Finish: black
Delivered with barndoor filter frame
Dimensions: 241 x 196 x 173 mm
Weight: 3.6 kg



WW 50W 3200K 10° 50°

BT-THEATRE 50WW

LED with 10° - 50° manual zoom. 50W warm white LED

Code : B06013 289€^{Incl. VAT}



Optics: 1x50W 3200K COB LED
manual zoom: 10° to 50°
330 lux at 5m and 10°, 77 lux at 5m and 40°
Integrated control unit with LCD display with drop-down menu
DMX IN/OUT with 3-pin XLR plugs
POWER IN with 1 m cord with plug
Power supply: 100-240V/50-60Hz
Power consumption: 55 W
Dissipation fan
Finish: black
Delivered with barndoor filter frame
Dimensions: 241 x 196 x 173 mm
Weight: 3.6 kg



WW 50W 3200K 10° 50°

BT-THEATRE 50WW

10° - 50° manual zoom LED. 50W warm white LED

Code : B06014 289€^{Incl. VAT}



Optics: 1x50W 3200K COB LED
manual zoom: 10° to 50°
330 lux at 5m and 10°, 77 lux at 5m and 40°
Integrated control unit with LCD display with drop-down menu
DMX IN/OUT with 3-pin XLR plugs
POWER IN with 1 m cord with plug
Power supply: 100-240V/50-60Hz
Power consumption: 55 W
Dissipation fan
Finish: white
Delivered with barndoor filter frame
Dimensions: 241 x 196 x 173 mm
Weight: 3.6 kg



PROJECTOR CASE 5

Flight case for 6 x BT-Theatre 50WW-60FC

Code : B03276 619€^{Incl. VAT}





Zoom 19°- 36°

Gel frame

Gobo holder

4-blade shutter

NEW



WW 40W 3200K

BT-PROFILE COMPACT 3200K
LED profile spot with 40W WW 3200K

Code : B06022 379€^{Incl. VAT}



NEW



WW 250W 3200K

BT-PROFILE250/LEDENGINE
160W COB LED cutout

Code : B06023 599€^{Incl. VAT}



Compact profile spot, the perfect choice for museums, art-galleries, stores, etc. 40W warm white LED for an excellent light output (used @ 70%: long lifespan) The projector can be dimmed using triac dimmers with an LED mode. Compatible power supplies: dsp2-led & dsp4-mk2
Color temperature = 3200K, CRI →90
Zoom lens with a beam angle of 19° to 36° (included)
With the 4 blade shutter you can give any desired shape to the beam.
Rugged black die-cast aluminum construction
Gobo Holder included (gobo size: 38mm, image 25mm)
Filter holder included
Safety Cable included

250W high power COB LED
Color temperature of 3200K.
Extremely quiet cooling system using heat pipe technology.
Compatible with ETC® Source Four optics.
Modes: manual, DMX
Different gradation curves
CRI: 97

Optics compatible with BT-PROFILE250/LEDENGINE

B06024	BT-PROFILE250/OPTIC 19DEG	19°	159€ ^{Incl. VAT}
B06025	BT-PROFILE250/OPTIC 26DEG	26°	159€ ^{Incl. VAT}
B06026	BT-PROFILE250/OPTIC 36DEG	36°	159€ ^{Incl. VAT}
B06027	BT-PROFILE250/OPTIC 50DEG	50°	159€ ^{Incl. VAT}
B06001	BT-PROFILE160/OPTIC 15-30	15° à 30°	249€ ^{Incl. VAT}
B06002	BT-PROFILE160/OPTIC 25-50	25° à 50°	249€ ^{Incl. VAT}

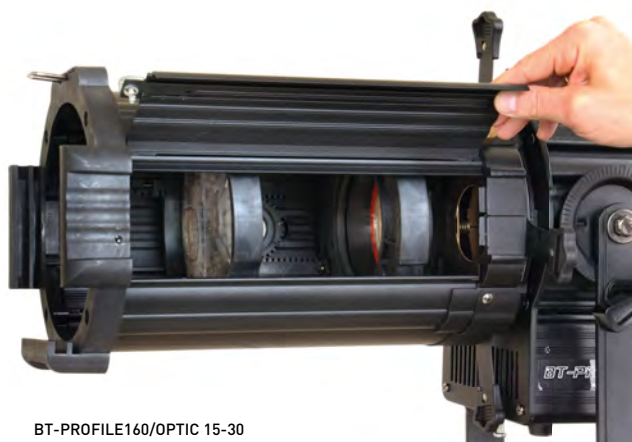

BT-PROFILE160/OPTIC 15-30



BT-PROFILE160/GOBO HOLDER
GOBO door for BT-PROFILE160/OPTIC

Code : B06003 16.90€^{Incl. VAT}



GOBO holder for BT-PROFILE160/OPTIC
Outer diameter of the gobos: 86mm,
Optical diameter: 64.5mm



BT-PROFILE160/IRIS
Iris for BT-PROFILE160/OPTIC

Code : B06004 95€^{Incl. VAT}





Iris for BT-PROFILE160/OPTIC
Opening diameter: adjustable from 5 to 74 mm

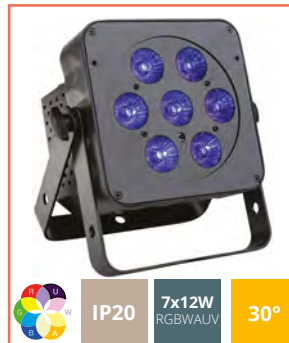

FLAT PROJECTORS



irLDFLAT
12x12SIXb
 12x12W six-colour LEDs

Code : H10143 269€Incl. VAT



Contest 

12x12W six-colour RGBWA + UV LEDs
 Beam opening: 40°
 Light intensity: 1400 Lux at 3 m
 Infrared remote control
 Digital display with drop-down menu
 Input and output on IEC plugs
 Modes of operation:
 2-9 channel DMX, fixed colours, Step or Fade programs, Auto mode with sound sensitivity, Slave Mode, Editing and playback of a 20-step program
 Power consumption: 160 W
 Power supply: AC 100/240V - 50/60Hz
 DMX input and output
 Dimensions: 275 x 310 x 110 mm
 Net weight: 3.4 kg

FLY8-irLEDFLAT
 Flight case for 8x FLAT12SIX

Code : H10739 399€Incl. VAT

Contest 







LED PLANO 6in1
 7x12W RGBWA + UV! LEDs

Code : B04961 189€Incl. VAT

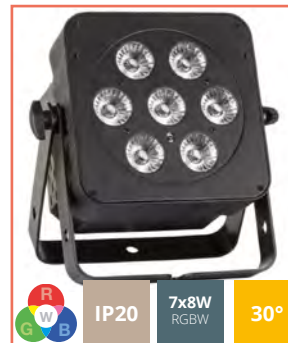
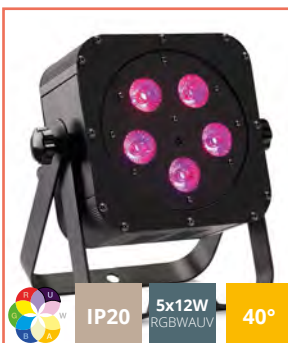
JBSYSTEMS 

7x12W six-colour RGBWA + UV LEDs
 Beam opening: 30°
 Infrared remote control
 Ready for a DMX wireless connection with the WTR-DMX option
 Digital display with drop-down menu
 Input and output on IEC plugs
 Modes of operation:
 Standalone, Master/slave mode, DMX mode, usable with LEDCON-XL controller
 DMX input and output
 Power consumption: 50 W
 Power supply: AC 100/240V - 50/60Hz
 Dimensions: 210 x 130 x 230 mm
 Net weight: 2.83 kg







irLEDFLAT-5x12SIXb
 Compact projector with six-colour LEDs, 5x12W LEDs

Code : H10142 169€Incl. VAT

Contest 



5x12W six-colour RGBWA + UV LEDs
 Beam opening: 40°
 Light intensity: 580 Lux at 3 m
 Infrared remote control
 Digital display with drop-down menu
 Input and output on IEC plugs
 Modes of operation:
 2-9 channel DMX, fixed colours, Step or Fade programs, Auto mode with sound sensitivity, Slave Mode, Editing and playback of a 20-step program
 Power consumption: 80 W
 Power supply: AC 100/240V - 50/60Hz
 DMX input and output
 Dimensions: 240 x 265 x 110 mm
 Net weight: 2.8 kg

LIGHT EFFECT CASE 1
 Solid flight case for the transport of light effects.

Code : B03216 219€Incl. VAT

JVCase 

Solid flight case for transport
 Divided into 5 compartments:
 2x compartments (465x285x260mm)
 1x compartment (190x69x260mm)
 1x compartment (150x69x260mm)
 1x compartment (95x69x260mm)

LED PLANO 7FC-BLACK
 7x8W RGBW LEDs

Code : B04958 139€Incl. VAT

JBSYSTEMS 

7x8W RGBW LEDs
 Beam opening: 30°
 Infrared remote control
 Ready for a DMX wireless connection with the WTR-DMX option
 Digital display with drop-down menu
 Input and output on IEC plugs
 Modes of operation:
 Standalone, Master/slave mode, DMX mode, usable with LEDCON-02 or LEDCON-XL controllers
 DMX input and output
 Finish: black
 Power consumption: 38 W
 Power supply: AC 100/240V - 50/60Hz
 Dimensions: 210 x 120 x 220 mm
 Net weight: 2.35 kg

FLAT PROJECTORS



LED PLANO 7FC-WHITE
7x8W RGBW LEDs

Code : B04959 139€^{Incl. VAT}





RAVE SPOT
3 effects in a single device. Wireless DMX

Code : B06201 149€^{Incl. VAT}





PARTY SPOT
7x8W RGBW compact LEDs

Code : B04189 89€^{Incl. VAT}



7x8W RGBW LEDs
Beam opening: 30°
Infrared remote control
Ready for a DMX wireless connection with the WTR-DMX option
Digital display with drop-down menu
Input and output on IEC plugs
Modes of operation:
Standalone, Master/slave mode, DMX mode, usable with LEDCON-02 or LEDCON-XL controllers
DMX input and output
Finish: white
Power consumption: 38 W
Power supply: AC 100/240V - 50/60Hz
Dimensions: 210 x 120 x 220 mm
Net weight: 2.35 kg

3 effects in a single device!
9 x4W RGB UV LEDs
1 central 30W RGB COB LED.
Strobe LED: 21x0.5 W white LEDs.
Infrared remote control
Ready for a DMX wireless connection with the WTR-DMX option
Digital display with drop-down menu
Input and output on IEC plugs
Modes of operation: Standalone, Master/slave mode, 1-22 channel DMX mode
DMX input and output
Power consumption: 78 W
Power supply: AC 100/240V - 50/60Hz
Dimensions: 280 x 275 x 76 mm
Net weight: 1.81 kg

7x8W RGBW LEDs
Digital display with drop-down menu
Input and output on IEC plugs
Modes of operation:
Standalone, Master/slave mode, DMX mode, usable with LEDCON-02 or LEDCON-XL controllers
DMX input and output
Power consumption: 38 W
Power supply: AC 100/240V - 50/60Hz
Dimensions: 190 x 190 x 140 mm
Net weight: 1.48 kg



COB SLIM100-RGB
Energy efficient compact COB LED projector!



Code : B04415 309€^{Incl. VAT}



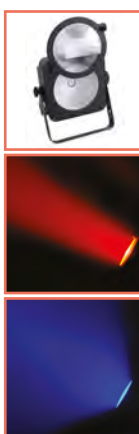

COB-PLANO
36W RGB COB, 100°+15°

Code : B04951 145€^{Incl. VAT}

CASE for 4x COB-PLANO
4x COB-PLANO + 1x LEDCON-02 Mk2

Code : B03252 129€^{Incl. VAT}



1x100W RGB COB LED
Beam opening: 15° or 70°
Light intensity: 1165 Lux at 3 m at 15°
Ready for a DMX wireless connection with the WTR-DMX option
Infrared remote control
Digital display with drop-down menu
Mains input/output on Powercon plugs
Modes of operation:
Standalone, Master/slave, DMX mode, usable with LEDCON-02 MK2 or LEDCON-XL controllers
Power consumption: 120 W
Power supply: AC 100/240V - 50/60Hz
DMX input and output
Dimensions: 245 x 280 x 140 mm
Net weight: 3.46 kg

1x36W RGB COB LED
Beam opening: 15° or 100°
Infrared remote control
Digital display with drop-down menu
Input and output on IEC plugs
Modes of operation:
Standalone, Master/slave, DMX mode, usable with LEDCON-02 MK2 controllers or LEDCON-XL controllers
Power consumption: 40 W
Power supply: AC 100/240V - 50/60Hz
DMX input and output
Dimensions: 202 x 120 x 224 mm
Net weight: 2.14 kg

Lightweight and compact case designed for
4x COB-PLANO + LEDCON-02 Mk2
External dimensions: 550 x 315 x 250 mm



PAR PROJECTORS





4x36W
COB RGB

15°
100°

COB-4BAR
4xCOB RGB 36W + IR + Flight case

Code : B04952 439€^{Incl. VAT}



COB-4BAR FOOT-CONTROL
Pedal assembly for COB-4BAR

Code : B04953 49€^{Incl. VAT}





CASE for COB-4BAR
Lightweight and compact case, specially designed to carry a COB-4BAR

Code : B03249 159€^{Incl. VAT}



4x1 36W RGB COB LED
Beam opening: 15° or 100°
Infrared remote control
Ready for a DMX wireless connection with the WTR-DMX option
Digital display with drop-down menu
Input and output on IEC plugs
Modes of operation:
Standalone, Master/slave, DMX mode, usable with LEDCON-02 MK2 LEDCON-XL, COB-4BAR FOOTCONTROL controllers
Power consumption: 120 W
Power supply: AC 100/240V - 50/60Hz
DMX input and output
Dimensions: 1000 x 82 x 320mm
Net weight: 11 kg

Lightweight and compact case, specially designed to carry a COB-4BAR
External dimensions: 105 x 34 x 16 cm





IP20 **14x5W**
RGBW

14°

STAGE BEAMER FC - INDOOR
LED proj. 14x5W RGBW 14°

Code : B05504 399€^{Incl. VAT}



Optics: 14x5W RGBW LEDs
Opening angle: 14°
Integrated control unit with display with drop-down menu
DMX IN / OUT with 3- and 5-pin XLR plugs
POWER IN/OUT with Powercon plugs
Power supply: 100-240V/50-60Hz
Power consumption: 65W
Natural convection cooling
Finish: cast aluminium painted black
Dimensions: 245 x 205 x 245 mm
Weight: 4.96 kg





12x12W
RGBW+UV

15°

BT-STAGEPAR 6in1
12x12W RGBWA projector + UV - 15°





Code : B04377 339€^{Incl. VAT}



12x12W six-colour RGBWA + UV LEDs
Beam opening: 25°
Digital display with drop-down menu
Mains output on IEC plugs
Modes of operation:
1-9 channel DMX, Fixed colours, Step or Fade programs, Auto mode with sound sensitivity, Slave mode,
Mode: Halogen lamp or Diode
White balance
Remote setup: RDM
Power supply: AC 100/240V - 50/60Hz
DMX input and output
finish: black
Dimensions: 300 x 275 x 300 mm
Net weight: 3.5 kg



PAR PROJECTORS



18x12W
RGBWAUV

40°

irLED64-18x12SIXsb
PAR64 with RGBWAUV LEDs - With infrared remote control

Code : H10138 349€^{Incl. VAT}



18x12W six-colour RGBWA + UV LEDs
Beam opening: 40°
Light intensity: 3350 Lux at 3 m
Infrared remote control
Digital display with drop-down menu
Input and output on IEC plugs
Modes of operation:
2-9 channel DMX, Fixed colours, Step or Fade programs, Auto mode with sound sensitivity, Slave Mode, Editing and playback of a 20-step program
Power consumption: 240 W
Power supply: AC 100/240V - 50/60Hz
DMX input and output
Black aluminium housing
Dimensions: 340 x 270 x 220 mm
Net weight: 5.4 kg





18x12W
RGBWAUV





40°

irLED64-18x12SIXss
PAR64 with RGBWAUV LEDs - With infrared remote control - Aluminium

Code : H10137 349€^{Incl. VAT}



18x12W six-colour RGBWA + UV LEDs
Beam opening: 40°
Light intensity: 3350 Lux at 3 m
Infrared remote control
Digital display with drop-down menu
Input and output on IEC plugs
Modes of operation:
2-9 channel DMX, Fixed colours, Step or Fade programs, Auto mode with sound sensitivity, Slave Mode, Editing and playback of a 20-step program
Power consumption: 240 W
Power supply: AC 100/240V - 50/60Hz
DMX input and output
Silver aluminium housing
Dimensions: 340 x 270 x 220 mm
Net weight: 5.4 kg



18x10W
RGBWA





40°

irLED64-18x10FIVEsb
PAR64 with 18x10W 5-colour LEDs
Black finish

Code : H10072 329€^{Incl. VAT}



18x10W RGB White + Amber LEDs
Beam opening: 40°
Light intensity: 2150 Lux at 3 m
Infrared remote control
Digital display with drop-down menu
Input and output on IEC plugs
Modes of operation:
2-8 channel DMX, Fixed colours, Step or Fade programs, Auto mode with sound sensitivity, Slave mode, Editing and playback of a 20-step program
Power consumption: 165 W
Power supply: AC 100/240V - 50/60Hz
DMX input and output
Black aluminium housing
Dimensions: 340 x 270 x 220 mm
Net weight: 4.6 kg



18x3W
RGB





40°

irLED64-18x3TCsb
PAR64 with 18x3W TRI LEDs Black finish

Code : H9876 199€^{Incl. VAT}



18x3W RGB LEDs
Beam opening: 40°
Light intensity: 1150 Lux at 3 m
Infrared remote control
Digital display with drop-down menu
Input and output on IEC plugs
Modes of operation:
2-6 channel DMX, Fixed colours, Step or Fade programs, Auto mode with sound sensitivity, Slave mode,
Power consumption: 60 W
Power supply: AC 100/240V - 50/60Hz
DMX input and output
Black aluminium housing
Dimensions: 340 x 270 x 220 mm
Net weight: 4.3 kg



18x3W
RGB

40°

irLED64-18x3TCss
PAR64 with 18x3W TRI LEDs Aluminium finish

Code : H9875 199€^{Incl. VAT}



18x3W RGB LEDs
Beam opening: 40°
Light intensity: 1150 Lux at 3 m
Infrared remote control
Digital display with drop-down menu
Input and output on IEC plugs
Modes of operation:
2-6 channel DMX, Fixed colours, Step or Fade programs, Auto mode with sound sensitivity, Slave mode,
Power consumption: 60 W
Power supply: AC 100/240V - 50/60Hz
DMX input and output
Silver aluminium housing
Dimensions: 340 x 270 x 220 mm
Net weight: 4.3 kg



FLY-irLED64x6
Flight case for 6 PAR64

Code : H10338 399€^{Incl. VAT}



External dimensions - L x W x H:
850 x 580 x 585 mm
Compartment dimensions:
260 x 260 mm Depth: 440 mm
Hood thickness: 65 mm

PAR PROJECTORS



WW 100W 3200K 60°

COB PAR56-100WW Black
LED projector with parabolic reflector

Code : B04411 329€^{Incl. VAT}



Optics: 1x100W 3200K COB LED
Opening angle: 60°
Digital display with drop-down menu
Mains output on IEC plugs
Modes of operation:
1-2 channel DMX, Fixed colours, Step or Fade programs, Auto mode with sound sensitivity, Slave mode,
Mode: Halogen lamp or Diode
Power supply: 100-240V/50-60Hz
DMX input and output
Finish: black
Delivered with 25° lens, filter door
Dimensions: 417 x 286 x 260 mm
Weight: 2.8 kg



WW 100W 3200K 60°

COB PAR56-100WW Silver
LED projector with parabolic reflector

Code : B04410 299€^{Incl. VAT}



Optics: 1x100W 3200K COB LED
Opening angle: 60°
Digital display with drop-down menu
Mains output on IEC plugs
Modes of operation:
1-2 channel DMX, Fixed colours, Step or Fade programs, Auto mode with sound sensitivity, Slave mode,
Mode: Halogen lamp or Diode
Power supply: 100-240V/50-60Hz
DMX input and output
Finish: silver
Delivered with 25° lens, filter door
Dimensions: 417 x 286 x 260 mm
Weight: 2.8 kg



100W COB RGB 50°

COB PAR56-RGB
100xW RGB COB LED

Code : B04403 349€^{Incl. VAT}



Optics: 1x100W RGB COB LED
Opening angle: 50°
Digital display with drop-down menu
Mains output on IEC plugs
Modes of operation:
3-, 4- and 5-channel DMX, Fixed colours, Step or Fade programs, Auto mode with sound sensitivity, Slave mode,
Power supply: 100-240V/50-60Hz
DMX input and output
Finish: black
Delivered with 25° lens, filter door
Dimensions: 417 x 286 x 260 mm
Weight: 2.8 kg



COB BARNDOOR/Black
Barndoor for COB PAR56

Code : B04413 34.90€^{Incl. VAT}



COB BARNDOOR/Silver
Barndoor for COB PAR56

Code : B04414 29€^{Incl. VAT}

PROJECTOR CASE
Flight case for carrying 4 projectors

Code : B03253 349€^{Incl. VAT}



For:
BRITEQ COB-PAR
BRITEQ BT-Stagepar 6in1
BRITEQ BT-Theatre 1EZ
BRITEQ BT-Theatre 100EC

PAR PROJECTORS





15W
RGBW

10°

RETRO-PAR20 RGBW
15W RGBW RETRO-PAR20 LED IR Remote Control

Code : B05129 66.90€^{Incl. VAT}



RETRO-PAR20 LED projector
1x15W RVBW LED.
Opening: 10°
Infrared remote control IR-3
16 fixed colours [with dimming].
"Fade", "soft transition" and "flash"
colour interlacing [with speed control].
Strobe function [with speed control].
Easy to use sound control mode.
Power supply: 100-240V/50-60Hz
finish: black
Dimensions: 198 x 112 x 100 mm
Weight: 0.65 kg





15W
RGBW

4°

BEAMSPOT1-DMX FC
15W RGBW projector, equipped with a very narrow 4° lens

Code : B04957 149€^{Incl. VAT}



1x15W RGBW LED
Openings: 4° | 10° | 45°
Power consumption: 17 W
Power supply: AC100V-240V. 60Hz-50Hz
Powercon IN/OUT
DMX 3-pin IN/OUT
DMX control: 4-7 channels
Dimensions: 125 x 196 x 172 mm
Net weight: 1.23 kgs



WW

15W

4°

BEAMSPOT1-DMX WW
15W WARM WHITE 4° lens

Code : B04960 149€^{Incl. VAT}



1x15W warm white 3200K LED
Openings: 4° | 10° | 45°
Power consumption: 17 W
Power supply: AC100V-240V. 60Hz-50Hz
Powercon IN/OUT
DMX 3-pin IN/OUT
DMX control: 1-2 channels
Dimensions: 125 x 196 x 172 mm
Net weight: 1.23 kgs

NW

15W

4°

BEAMSPOT1-TRIAC NW
15W WHITE projector

Code : B04955 99€^{Incl. VAT}



1x15W natural white 4500K LED
Openings: 4° | 10° | 45°
NO DMX: can be controlled using a
traditional triac dimmer / triac light
modulator or the dimmer located on the
rear panel.
Power consumption: 17 W
Power supply: AC100V-240V. 60Hz-50Hz
Fixed power cord with standard power
outlet
Dimensions: 125 x 196 x 172 mm
Net weight: 1.23 kgs



WW

15W

4°

BEAMSPOT1-TRIAC WW
This 15W PINSPOt

Code : B04954 99€^{Incl. VAT}



1x15W warm white 3200K LED
Openings: 4° | 10° | 45°
NO DMX: can be controlled using a
traditional triac dimmer / triac light
modulator or the dimmer located on the
rear panel.
Power consumption: 17 W
Power supply: AC100V-240V. 60Hz-50Hz
Fixed power cord with standard power
outlet
Dimensions: 125 x 196 x 172 mm
Net weight: 1.23 kgs



TRADITIONAL PAR PROJECTORS



PAR46-BARN/black
Barndoor for PAR46

Code : B02079 11.90€^{Incl. VAT}



PAR46-BARN/silver
Barndoor for PAR46

Code : B02080 11.90€^{Incl. VAT}



PINSPO/Black
Projector for PAR36 lamp

Code : B02034 17.90€^{Incl. VAT}



Projector for 30W/6V PAR 36 lamp
Equipped with a transformer, fuse holder and clips to fix the lamp
Finish: black
Without lamp



PAR30/black
Projector for PAR30 or PAR20 lamp

Code : B02088 19.90€^{Incl. VAT}



Projector for Par 30 or Par 20 lamp
Compatible with halogen lamps and E27 socket LED lamps
Power supply 230V AC
Finish: black
Total length without holder: 22 cm
Without lamp



PAR30/silver
Projector for PAR30 or PAR20 lamp

Code : B02087 19.90€^{Incl. VAT}



Projector for Par 30 or Par 20 lamp
Compatible with halogen lamps and E27 socket LED lamps
Power supply 230V AC
Finish: silver
Total length without holder: 22 cm
Without lamp



PAR30-BARN/black
Barndoor for PAR30

Code : B02077 10.90€^{Incl. VAT}



PAR30-BARN/silver
Barndoor for PAR30

Code : B02078 10.90€^{Incl. VAT}



TRADITIONAL PAR PROJECTORS



PAR20/black
Projector for PAR20 lamp

Code : B02086 15.90€^{Incl. VAT}



Projector for PAR20 lamp
Finish: black
Total length without holder: 17cm
Without lamp



PAR20/silver
Projector for PAR20 lamp

Code : B02085 15.90€^{Incl. VAT}



Projector for PAR20 lamp
Finish: silver
Total length without holder: 17cm
Without lamp



PAR20-BARN/black
Barndoor for PAR20

Code : B02075 9.90€^{Incl. VAT}



PAR20-BARN/silver
Barndoor for PAR20

Code : B02076 9.90€^{Incl. VAT}



PAR16/black GU10 socket
Projector for PAR16 lamp

Code : B02061 13.90€^{Incl. VAT}



GU10 socket for the use of: LED lamps (GU10) Halogen lamp (35W or 50W/230V)
Finish: black
No transformer necessary
Total length without holder: 14.5cm
Without lamp



PAR16/Silver GU10 socket
Projector for PAR16 lamp

Code : B02055 13.90€^{Incl. VAT}



GU10 socket for the use of: LED lamps (GU10) Halogen lamp (35W or 50W/230V)
Finish: silver
No transformer necessary
Total length without holder: 14.5cm
Without lamp



PAR16-BARN/black
Barndoor for PAR16

Code : B02073 8.90€^{Incl. VAT}



PAR16-BARN/silver
Barndoor for PAR16

Code : B02074 8.90€^{Incl. VAT}



BLINDERS & PROJECTORS

BT-NONABEAM

Exclusive effect for
the show



- ✓ Design created by service providers for service providers
- ✓ Light power in a compact format
- ✓ Rendering that surpasses traditional lamps
- ✓ The Glow effect for smooth transitions

BLINDERS & PROJECTORS



BT-NONABEAM - BQ1 (FRANCE BE CH)
9x60W WW/CW

Code : B05513 2199€^{Incl. VAT}



BT-NONABEAM - BQ2 (EXPORT)
9x60W WW/CW beam/ RGB

Code : B05521 2199€^{Incl. VAT}



CASE FOR 4xBT-NONABEAM
Flight case pour 4 x BT-Nonabeam

Code : B03284 669€^{Incl. VAT}

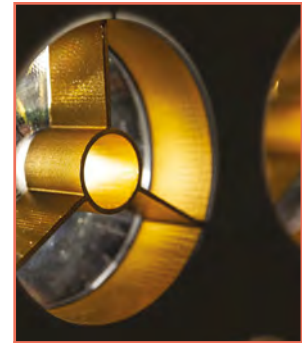

BT-NONABEAM set 9 louvers GOLD

Code : B05514 49€^{Incl. VAT}



Mains supply input: 100 to 240 V AC, 50/60 Hz
Electrical connections: Neutrik® PowerCON TRUE1
Power consumption (full speed): 730 W
Power factor: 0.95
Protection class: 1
Protection class: IP20
Fuse: 250 V 6 A thermal fuse
DMX connections: 3 and 5 pin XLR and male/female XLR connections
Number of DMX channels used: 13 + 29 + 45 channels
Beam lamps: 9 x LED WHITE, 60 W (30W 3000K / IRC: 91 + 30W 6000K)
Lamps for glow effect: 72 x RGB LED 1 W
LED refresh rate: 1.2 kHz
Beam angle: 4° to 4.5°
Ambient temperature: 40 ° C
Dimensions (W x H x D): 580 x 223 x 142 mm
Weight: 15 kg (16 kg with hook)

Mains supply input: 100 to 240 V AC, 50/60 Hz
Electrical connections: Neutrik® PowerCON TRUE1
Power consumption (full speed): 730 W
Power factor: 0.95
Protection class: 1
Protection class: IP20
Fuse: 250 V 6 A thermal fuse
DMX connections: 3 and 5 pin XLR and male/female XLR connections
Number of DMX channels used: 13 + 29 + 45 channels
Beam lamps: 9 x LED WHITE, 60 W (30W 3000K / IRC: 91 + 30W 6000K)
Lamps for glow effect: 72 x RGB LED 1 W
LED refresh rate: 1.2 kHz
Beam angle: 4° to 4.5°
Ambient temperature: 40 ° C
Dimensions (W x H x D): 580 x 223 x 142 mm
Weight: 15 kg (16 kg with hook)



BLINDERS & PROJECTORS



Powerpixel4-RGB
Bar with 4 30W TRI COB LEDs
With LCD display

Code : B04400 429€^{Incl. VAT}



4 COB LEDs
30W tri-colour LEDs
Beam opening: 60°
DMX 3- and 5-pin XLR input and output
Power input and output on PowerCON®
(maximum 20 projectors connected to each other)
Power consumption: 120 W
Power supply: AC 100/240V - 50/60Hz
Cooling by temperature regulated ventilation
Dimensions: 440 x 150 x 180 mm
Net weight: 5 Kg



Powerpixel8-RGB
Bar with 8 30W TRI COB LEDs
With LCD display

Code : B04401 599€^{Incl. VAT}



8 COB LEDs
30W tri-colour LEDs
Beam opening: 60°
DMX 3- and 5-pin XLR input and output
Power input and output on PowerCON®
(maximum 10 projectors connected to each other)
Power consumption: 240 W
Power supply: AC 100/240V - 50/60Hz
Cooling by temperature regulated ventilation
Dimensions: 880 x 60 x 170 mm
Net weight: 8 Kg



PROJECTOR CASE 2
Flight case for POWERPIXEL8-RGB,
POWERPIXEL4-RGB, BEAMBAR10-RGBW,
BEAMBAR5-RGBW

Code : B03257 649€^{Incl. VAT}



BT-BLINDER2 IP

Ready for everything
and in any weather
conditions.

- ✓ Robustness and Weather-Resistant
- ✓ Red-Shift effect
- ✓ Professional "line array" rigging



BT-BLINDER2 IP

Code : B05520 899€^{Incl. VAT}



Mains power input: 100 to 240 V AC, 50/60 Hz Internal fuse: 250 V AC/T2A
Electrical connections: Neutrik® PowerCON TRUE1 (input/output)
Power consumption (full power): 310 W
Power factor: → 0.95
Series connection: 5 units (at 240 V AC)
Protection class: 1
Protection class: IP65 - outdoor use
DMX connections: 5-pin male/female XLR (modification kit to 3-pin XLR available)
Number of DMX channels used: 4 + 6 + 10 channels
LED : 2 of 135 W (warm white and yellow) Color temperature (CCT) : 1 650 K 3 000 K (AMBER EFFECT effect)
IRC factor: → 97
LED refresh rate: 3.6 kHz
Strobe frequency: 0.5 - 30 Hz
Ambient temperature: 40 °C
Weight: 8.1 kg (8.8 kg with set of fixing elements)



BT-BLINDER2 IP RIGGING SET

Rigging set for BT-BLINDER2 IP

Code : B05522 99€^{Incl. VAT}



CASE FOR 3x BT-BLINDER2 IP

Flightcase for 3 x BT-BLINDER2 IP

Code : B03290 549€^{Incl. VAT}



BLINDERS & PROJECTORS



COB Blinder 2x100W
LED BLINDER equipped with two white 100Watt LED projectors

Code : B04402 599€^{Incl. VAT}

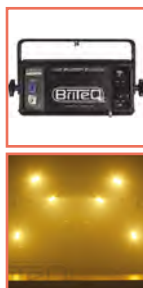

BEAM MATRIX5x5-RGBW
5x5 MATRIX effect, 25x 15W RGBW 4.5°beams + Artnet

Code : B04416 990€^{Incl. VAT}

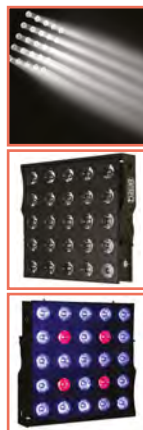

MATRIX5x5-CASE
Flight case for 6x MATRIX5x5

Code : B04422 359€^{Incl. VAT}



LED BLINDER equipped with two white 100Watt 3200k LED projectors
Opening angle: 60°
The two projectors can be controlled independently
DMX mode: 1, 2 or 4 channels
Static mode: Stroboscopic effect dimmer Master/Slave Mode, Variable stroboscopic effect
Halogen (slow) or LED (fast) mode
Dimming 16 bit from 0% to 100%
DMX IN/OUT on XLR 3/5-pin plug
POWER IN/OUT with Powercon
Power: AC 100 - 240V, 50/60Hz
Power consumption: 235W
Dimensions: 440 x 144 x 355 mm
Weight: 4.46 kg

25 15W RGBW LEDs 5x5 Matrix
Lens opening: 4.5°
DMX mode: 4-150 channels
Ethernet input/output: Art-Net support
Internal programs in standalone mode or via DMX, Master/slave mode, static or fade colours, static or sound-triggered chasers.
Halogen (slow) or LED (fast) mode
Balancing of individual whites by Pixel
Four intensity variation curves
DMX IN/OUT on XLR 3/5-pin plug
POWER IN/OUT with Powercon
Power: AC 100 - 240V, 50/60Hz
Power consumption: 415W
Dimensions: 550 x 550 x 120 mm
Weight: 18 kg



FLOOD PROJECTORS



BT-RETRO

A retro look for a modern scenography
The compact version of the BT-VINTAGE with the same light quality and Glow effects.

The design of the projector allows them to be mechanically combined to form sets according to your needs

The BT-RETRO has an integrated DMX control to adjust the drive and RGB effects. It is prepared for television studios with a flicker-free LED refresh rate.



BT-RETRO
Vintage RGB projector

Code : B05518 849€^{Incl. VAT}

BT-RETRO coupling adapter
Adapter for BT-RETRO

Code : B05519 19€^{Incl. VAT}



CASE FOR 2xBT-RETRO
Flightcase for 2 x BT-RETRO

Code : B03289 529€^{Incl. VAT}



Mains power input: 100 to 240 V AC, 50/60 Hz
Halogen lamp (mains input 110 V AC): G9.5 - HPL-575W 120 V
Halogen lamp (mains input 230 V AC): G9.5 - HPL-575W 240 V
Maximum power consumption: 480 W (halogen (limited to 320 W) + LED (120 W) fully lit)
Fuse: 250 V T 6.3A (20 mm glass)
DMX connections: 3 and 5-pin male/female XLR XLR connections
Number of DMX channels used: 3 modes (5 + 6 + 7 channels)
RGB LED: 48 RGB units 3.5 W
LED refresh rate: 1,200 Hz
Weight: 8.66 kg
Lamp not supplied



HPL 575-X LL
(code B02171)

230V halogen lamp for BT-RETRO. For a warm and pleasant light

FLOOD PROJECTORS

This attractive retro-style projector is perfect for many applications.

The combination of its golden reflector and an HPL-575 lamp creates a warm and pleasant light. The high-power RGB LEDs can illuminate the reflector to produce incredible additional effects.

The BT-VINTAGE has an integrated DMX control to adjust the dimmer and RGB effects. It is prepared for TV studios with a flicker-free LED refresh rate.



BT-VINTAGE
Retro-style projector with golden reflector, HPL-575 lamp and RGB LEDs to produce incredible warm colour effects.

Code : B04547 1049€^{incl. VAT}



CASE for 2x BT-VINTAGE
Flight case for 2x BT-VINTAGE

Code : B03271 729€^{incl. VAT}



HPL 575-X LL
(code B02171)

230V halogen lamp for BT-VINTAGE. For a warm and pleasant light



RGB LEDs (156 x 1W RVB)
Wireless DMX: USB port for WTR-DMX dongle (optional)
PowerCON input and output
XLR 3/5-pin input and output
Power supply: AC 100/240V - 50/60Hz
Power consumption: 980W
Ventilation: natural convection
Dimensions: 696 x 650 x 370 mm
Net weight: 14 Kg
Lamp not supplied



EFFECT PROJECTORS

The BT-LEDROTOR is a 70x70cm high power LED effect fan for TV studios, rental, etc.

Each of the 6 blades is equipped with 5 RGB LED sections. You can control each blade and each of the 5 sections individually.

In addition, a UV LED effect has been added

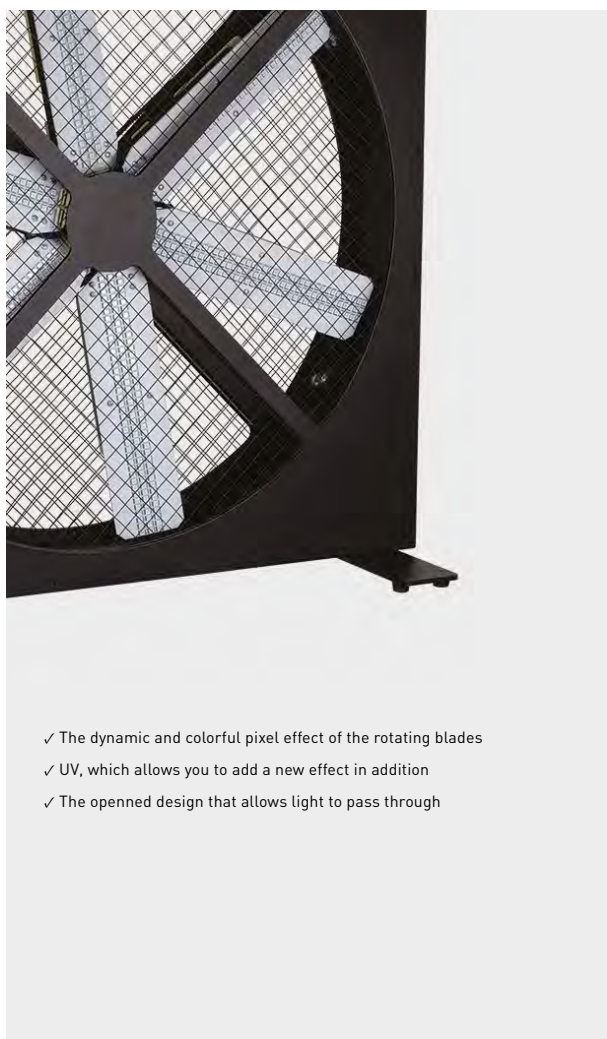
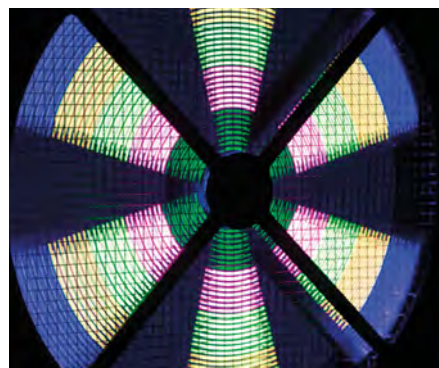
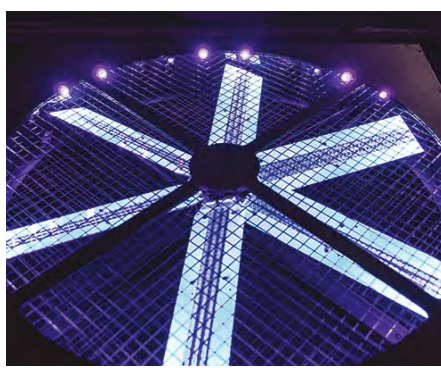

- ✓ The dynamic and colorful pixel effect of the rotating blades
- ✓ UV, which allows you to add a new effect in addition
- ✓ The opened design that allows light to pass through



BT-LEDROTOR
DMX controlled RGB+UV LED ROTOR

Code : B05516 1099€^{Incl. VAT}

BriteQ
LIGHT RESEARCH



CASE FOR 4xBT-LEDROTOR
Flight case for 4 x BT-Ledrotor

Code : B03283 759€^{Incl. VAT}

BriteQ
LIGHT RESEARCH

Mains Input: AC 100V – 240V, 50/60Hz
 Power connections: Neutrik® PowerCON
 Power consumption (full power): 240 W
 Daisy chaining: 9pcs (à 240Vac)
 Power factor: →0.95
 Protection class: 1
 IP-rating: IP20
 Fuse: 250V 3A thermal fuse (5 x 20mm)
 DMX connections: 3pin + 5pin XLR male / female
 DMX channels used: 5 + 12 + 33 channels
 UV LEDs: 32pcs 3W (UV, 405nm)
 RGB LEDs : 720pcs 0.2W RGB-leds
 LED refresh rate: 0.6 kHz
 Ambient temperature: 40°C
 Weight: 18kg (20.3kg incl. 2x floor stand)

HYBRID MOVING HEAD



- OSRAM SIRIUS HRI 280 (7800 K°) lamp
- BEAM: from 2.6° to 11°
- SPOT: from 5.2° to 23°
- 1 wheel with 13 colours
- 14 fixed gobos + open
- 9 replaceable rotating gobos
- 8-facet prism + linear with 6 facets
- Frost | Zoom + Focus

- 270W CW LED
- Linear zoom from 8 to 45°
- 3-facet prism
- Wheel with 7 rotating gobos + open
- Wheel with 9 colours including 2xCTO 1xCTB, UV + open
- Iris
- Frost
- Focus
- Trichromy



BTX-TITAN

BEAM + SPOT + WASH effects

Code : B04378 2599€^{Incl. VAT}



CASE FOR 2x BTX-TITAN

Flight case for 2x BTX-TITAN

Code : B03251 649€^{Incl. VAT}



BTX-SATURN

Hybrid Moving head with 270 W LED

Code : B04428 3190€^{Incl. VAT}



MOVING HEAD CASE

5

Flight case for 2x BTX-SATURN

Code : B03291 559€^{Incl. VAT}



OSRAM SIRIUS HRI 280 source
 Beam from 2.6° to 11°: 82,650 lux at 20 m
 Spot from 5.2° to 23°: 25400 lux at 10 m
 2 combinable prisms:
 8-facet circular rotating prism
 6-facet linear rotating prism
 wheel with 9 rotating gobos + open
 wheel with 14 fixed gobos + open
 wheel with 13 dichroic colours (CTO-CTB)
 Frost effect (WASH)
 Stroboscopic effects
 Motorised Focus + Zoom
 Variable dimmer from 0 to 100%
 DMX mode: 16, 24 or 25 channels
 Drop-down menu display
 Amplitude: 540° pan - 270° tilt
 Power consumption: 400W
 Power supply: AC 100/230V - 50/60Hz
 Dimensions: 391x287x583 mm
 Net weight: 22 Kg

270W CW LED source
 Linear zoom from 8 to 45°
 3-colour process with dichroic CMY filters
 3-facet circular rotating prism
 Wheel with 7 rotating gobos + open
 Wheel with 9 fixed gobos + 3 reducers
 Wheel with 9 colours including 2xCTO,
 1xCTB, UV + open
 Variable iris
 Frost effect (WASH)
 Stroboscopic effects motorised focus
 Electronic dimmer variable from 0 to
 100%
 DMX mode: 25 channels
 Drop-down menu display
 Amplitude: 540° pan - 270° tilt
 Power IN/OUT: Neutrik powerCON®
 TRUE-1
 DMX IN/OUT: XLR 3+5pin
 Power supply: AC 100/230V - 50/60Hz



HYBRID MOVING HEAD

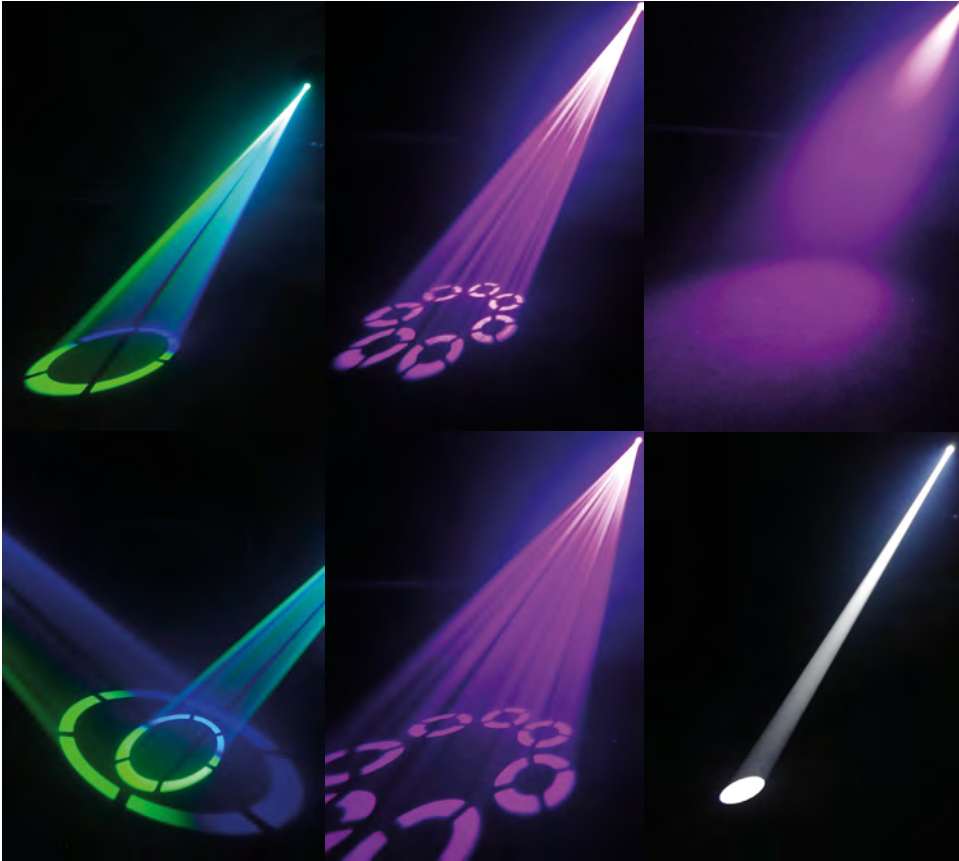

NEW

CHALLENGER BSW
150W Beam/Spot/Wash Moving head with motorized focus and zoom and 3 facet rotating prism!

Code : B05528 739€^{incl. VAT}

NEW

CASE FOR 2xCHALLENGERBSW

Code : B03295 389€^{incl. VAT}

- 3 in 1 moving head
- Beam 2° - Spot 15° - Wash 28°
- 150 W LED
- Beam/Spot/Wash
- Motorized focus
- Motorized zoom
- 3-facet rotating prism

150W 3in1 LED
Moving Head – Beam - Spot/Wash
Beam 2° - Spot 15° - Wash 28°
Focus controlled by DMX
Zoom controlled by DMX
PAN 540° - Tilt 270°
3 facet rotating prism
0-100% dimming and different strobe effects
Separate gobo wheel with 7 fixed gobos + open
Separate gobo wheel with 6 rotating gobos + open
Excellent built-in programs for wonderful, ever changing, light shows.
Multiple working modes: DMX-control: via 5, 17 or 20 channels
Standalone: sound activated with internal mic
Master/slave: Wonderful synchronized shows in standalone mode
Innovative 5CH SMART-DMX
Prepared for wireless DMX
WTR-DMX DONGLE [Briteq® order code: B04645]



Gobos

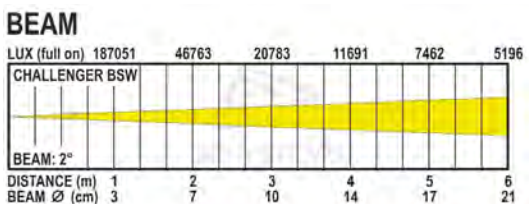
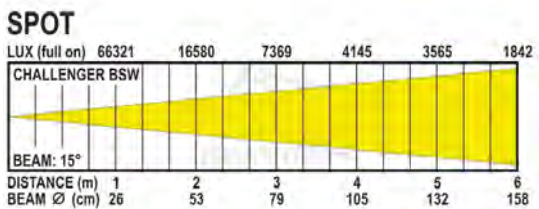
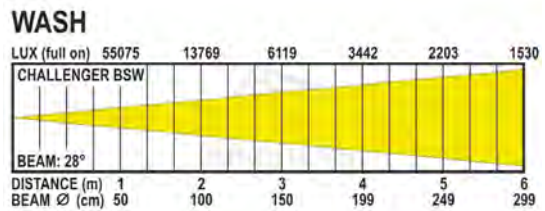



SPOT MOVING HEAD

BT-METEOR
Compact and extremely bright LED moving head

Code : B04384 929€^{incl. VAT}



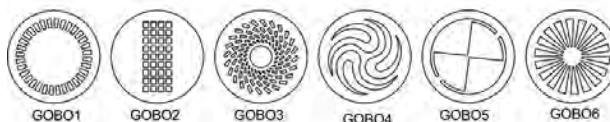

MOVING HEAD CASE 1
Flight case for 2x BT-METEOR, BT-70LS, BT-BEAM70

Code : B03255 269€^{incl. VAT}

100W CW LED source
 motorised focus
 Beam opening: from 12° to 16°
 Strobe, pulse effect and random strobe
 3-facet rotating prism
 wheel with 6 rotating gobos + open
 wheel with 8 dichroic colours + open
 Electronic dimmer variable from 0 to 100%
 DMX mode: 5, 11 or 14 channels
 Synchronised shows (internal microphone)
 Master / Slave mode
 Drop-down menu display to assign and
 select different modes
 Wireless DMX: WTR-DMX dongle (optional)
 Power consumption: 160W
 Power supply: AC 100/230V - 50/60Hz
 Dimensions: 290x180x435mm
 Net weight: 8.75 Kg

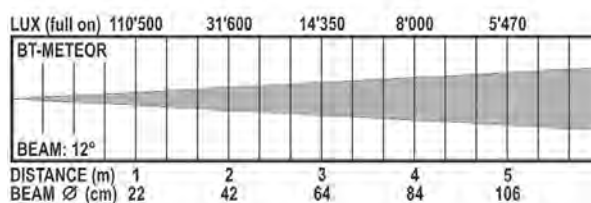

SPOT MOVING HEADS



BTX-HAWK

Very bright moving head controlled by a powerful 180 W LED module!

Code : B04398 990€Incl. VAT



180W CW LED source
 motorised focus
 Beam opening: 12°
 3-facet rotating prism + linear prism
 wheel with 7 rotating gobos + open
 wheel with 9 fixed gobos + open
 wheel with 7 dichroic colours + open
 Frost filter
 Electronic dimmer variable from 0 to 100%
 DMX mode: 11 or 13 channels
 Synchronised shows (internal microphone)
 Master / Slave mode
 Drop-down menu display to assign and
 select different modes
 Wireless DMX: WTR-DMX dongle (optional)
 Power consumption: 230W
 Power supply: AC 100/230V - 50/60Hz
 Dimensions: 393x558x288 mm
 Net weight: 16.5 Kg



CASE for 2x BTX-HAWK

Flight case for 2x Briteq BTX-HAWK

Code : B03263 439€Incl. VAT



CLUBSPOT

Compact moving head with 35W LED

Code : B05506 219€Incl. VAT



35W CW LED source
 Manual focus
 12° opening
 Stroboscopic effects
 Wheel with 7 fixed gobos + open
 Wheel with 7 dichroic colours + open
 Electronic dimmer variable from 0 to 100%
 DMX mode: 5, 9 or 11 channels
 Wireless DMX: WTR-DMX dongle (optional)
 Synchronised shows (internal microphone)
 Master / Slave mode
 Drop-down menu display to assign and
 select different modes
 Amplitude: 540° pan - 270° tilt
 DMX IN / OUT by XLR 3-pin plugs
 POWER IN / OUT by IEC plugs
 Power consumption: 60W maximum
 Power supply: AC 100/230V - 50/60Hz
 Dimensions: 284.5 x 205 x 149 mm
 Net weight: 3.5 Kg



MOVING HEAD CASE 6

Flight case for 4x Clubspot/Clubwash 2

Code : B03296 269€Incl. VAT

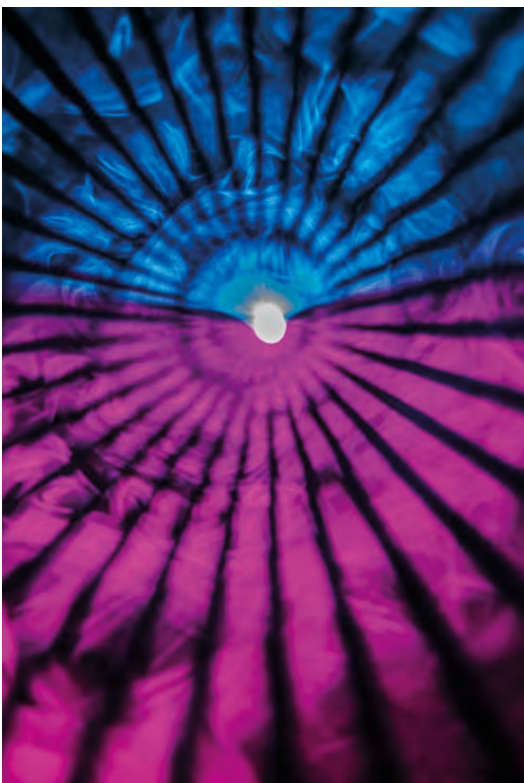

BTX-HAWK



CLUBSPOT

WASH/BEAM MOVING HEADS



BTX-CIRRUS II

The power, the beam angle and perfect pixel effect



BTX-CIRRUS II

Led Moving wash 19x30W FC pixel control 4-60°

Code : B05526

2899€Incl. VAT



Mains Input: AC 100-240V, 50/60Hz
 Power consumption: 650W
 DMX connections: 3pin & 5pin XLR IN/OUT
 Movement: Pan: 540° Tilt: 210° (+ Pan/Tilt lock for transport protection)
 Beam angle: 4°→60°
 DMX channels used: 20-29-48-77-86-96
 Channels
 Lamp: 19 Osram 30W RGBW LEDs
 Weight: 16 kg



MOVING HEAD CASE

4
Flight case for 2x BTX-CIRRUS

Code : B03288

729€Incl. VAT



- LED moving head 19x30 OSRAM LEDs
- 19000 Lux@5m/4°
- Full pixel mapping
- Zoom from 4° to 60°.
- Three-phase motors Moons
- Noiseless operation

LUX (red 640nm)	11112	4000	2041	1000	695	445
LUX (green 520nm)	24167	8700	4440	2175	1510	967
LUX (blue 445nm)	4235	1525	776	381	265	170
LUX (white 7200K)	32687	11770	6004	2942	2043	1307
LUX (full on)	70832	25500	13010	6375	4427	2833

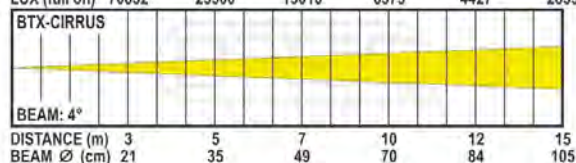

LUX (red 640nm)	341	155	79	39	27	17
LUX (green 520nm)	958	345	176	86	60	38
LUX (blue 445nm)	167	60	31	15	10.5	6.7
LUX (white 7200K)	1278	460	235	115	80	51
LUX (full on)	2722	980	500	245	170	109

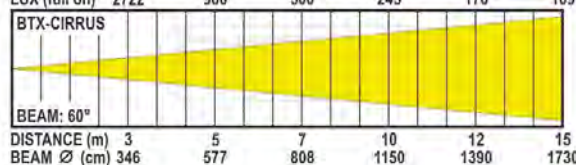

WASH/BEAM MOVING HEADS



BT-ORBIT

Led Moving wash 19x15W RGBW ring control 10-60deg

Code : B04423

1499€Incl. VAT



MOVING HEAD CASE 2

Flight case for 4 BT-Orbit / BT-W19 moving head

Code : B03272

629€Incl. VAT



19 15W RGBW LED sources
 Opening from 10° to 60° by motorised lighted zoom: 8400 LUX at 5m at 10°
 Programmable white balance
 Colour preset, Colour macro
 Strobe, pulse effect and random strobe
 Electronic dimmer variable from 0 to 100%
 Wireless DMX: WTR-DMX dongle (optional)
 Independent control of three colour zones (outer ring, inner ring and central point)
 DMX mode: 14 or 27 channels
 Drop-down menu display to assign and select different modes
 Amplitude: 540° pan - 270° tilt
 DMX IN / OUT by XLR 3/5-pin plugs
 POWER IN / OUT by Powercon plugs
 Power consumption: 290W maximum
 Power supply: AC 100/230V - 50/60Hz
 Dimensions: 395 x 325 x 225 mm
 Net weight: 9 Kg

LUX (full on)	196659	49165	21851	13125	8400	5833
BT-ORBIT						
BEAM: 10°						
DISTANCE (m)	1	2	3	4	5	6
BEAM Ø (cm)	17	35	52	70	87x	105
LUX (full on)	5586	1396	621	349	223	155
BT-ORBIT						
BEAM: 60°						
DISTANCE (m)	1	2	3	4	5	6
BEAM Ø (cm)	115	231	346	462	577	693

WASH/BEAM MOVING HEADS



BT-W30FC Mk2
Wash moving head 3 x 10W RGBW

Code : B04371 199€^{incl. VAT}



3 10W RGBW LED sources
25° opening
Strobe, pulse effect and random strobe
Electronic dimmer variable from 0 to 100%
DMX mode: 9 or 16 channels
Synchronised shows (internal microphone)
Master / Slave mode
CA8 compatible (option)
Drop-down menu display to assign and select different modes
Amplitude: 540° pan - 270° tilt
DMX IN / OUT by XLR 3-pin plugs POWER IN by IEC plug + 16A plug
Power consumption: 57.4W maximum
Power supply: AC 100/230V - 50/60Hz
Dimensions: 272 x 231 x 248 mm
Net weight: 6 Kg

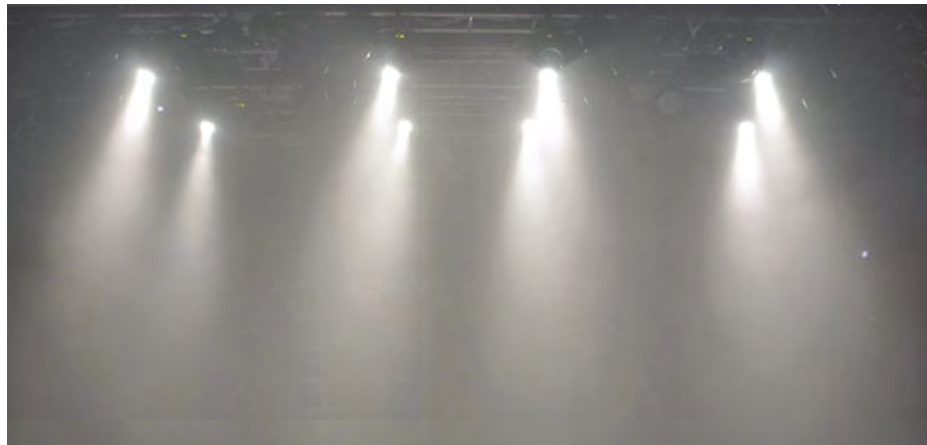
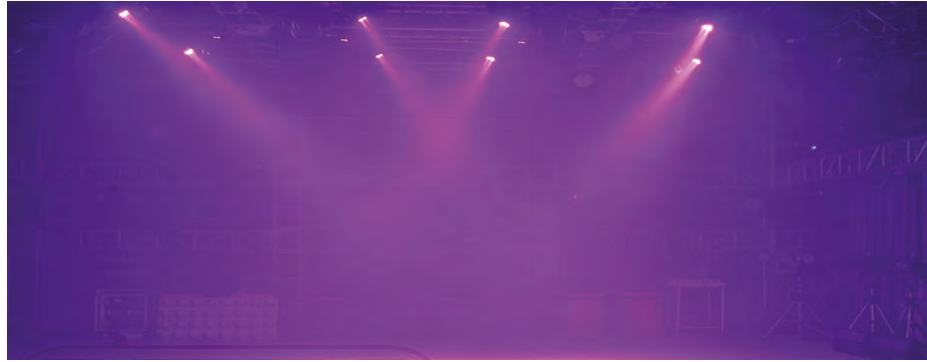

STRIKER
LED spot (10°-30W-white) and wash (6 x 8W RGBW) moving head

Code : B04190 469€^{incl. VAT}



Spot 30W CW LED sources
Wash 6 8W RGBW LED sources
Beam opening 10° (Spot)
Motorised focus
wheel with 7 fixed gobos + open
wheel with 7 dichroic colours + open
Electronic dimmer variable from 0 to 100%
Stroboscopic effects
DMX mode: 5 or 19 channels
Wireless DMX: WTR-DMX dongle (optional)
Synchronised shows (internal microphone)
Master / Slave mode
Drop-down menu display to assign and select different modes
Amplitude: 540° pan - 270° tilt
DMX IN / OUT with 3-pin plugs
POWER IN by IEC plug + 16A plug
Power consumption: 95W max.
Power supply: AC 100/230V - 50/60Hz
Dimensions: 150x230x330mm
Net weight: 4.53 Kg



CASE for 4x STRIKER
Flight case for 4x STRIKER

Code : B03267 289€^{incl. VAT}

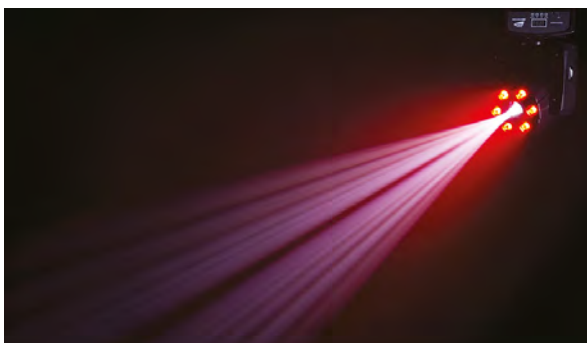
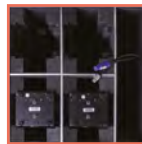

WASH/BEAM MOVING HEADS

NEW



CLUBWASH 2
A remarkably small and super lightweight 6in1 moving wash for DJ's, pubs and small discotheques

Code : B05529 209€^{Incl. VAT}



12x RGBWAUV 12W LEDs, 6 in 1
25° opening
0-100% dimming and various strobe effects
Wireless DMX: WTR-DMX DONGLE!
(optional, code B04645)
DMX control: via 5, 9 or 15 channels
Music mode
Master/Slave
Power consumption: 160 W
Weight: 3.5kg



A remarkably small and super light lyre. Ultra powerful with its RGBWAUV 12W, 6 in 1 leds. The perfect solution for many applications.

Prepared for wireless DMX: just plug in a WTR-DMX DONGLE!
(optional, code Briteq® B04645)



CLUBWASH
Wash moving head 7 x 12W RGBWAUV

Code : B05505 159€^{Incl. VAT}



7 12W RGBWAUV LED sources
25° opening
Stroboscopic effects
Electronic dimmer variable from 0 to 100%
DMX mode: 5, 9 or 15 channels
Wireless DMX: WTR-DMX dongle (optional)
Synchronised shows (internal microphone)
Master / Slave mode
CA8 compatible (option)
Drop-down menu display to assign and select different modes
Amplitude: 160° pan - 90° tilt
DMX IN / OUT by XLR 3-pin plugs
POWER IN / OUT by PowerCON plugs
Power consumption: 90W maximum
Power supply: AC 100/230V - 50/60Hz
Dimensions: 322.4 x 266.5 x 154 mm
Net weight: 3 Kg

NEW



CLUBWASH MINI
A remarkably small and super lightweight 6in1 moving wash!

Code : B05530 119€^{Incl. VAT}



4x RGBWAUV LEDs 12W, 6in1
25° opening
Power consumption only 60 W!
0-100% dimming and various strobe effects
DMX control: via 5, 9 or 15 channels
Music mode
Master/slave.
Power consumption: 60 W
Weight: 1.6kg

NEW



MOVING HEAD CASE 6
Flight case for 4x Clubspot/Clubwash 2

Code : B03296 269€^{Incl. VAT}



BEAM MOVING HEAD



A super compact but very powerful moving beam projector based on the brand-new SIRIUS HRI-100 discharge lamp from OSRAM The advanced optics guarantee an incredibly bright beam with excellent specs:

- Brightness : 310'000 lux @ 5m and 77'000 lux @ 10m!
- 3° Beam angle
- 10 sharp gobos + 4 beam shapers + open
- 14 carefully selected dichroic colors + open
- Very fast mechanical dimmer/shutter
- Different strobe functions

8-facet rotating prism with different macros, controlled by DMX

The very fast pan/tilt movements [540°/270°] assure very dynamic show programming.

Two DMX-modes:

PRO: 12ch mode with 16bit resolution pan/tilt resolution and position correction.

AUTO: 5ch mode with music controlled pan/tilt + control for dim, strobe, gobo, color, P/T speed.



BT-TRACKER

Super compact but very powerful moving head SIRIUS HRI-100 lamp from OSRAM!

Code : B04387

929€^{Incl. VAT}



Osram SIRIUS HRI 100W source
 Light power: 307200 lux at 5m
 Beam opening: 3°
 Strobe, pulse effect and random strobe
 8-facet rotating prism
 wheel with 10 gobos + 4 reducers + open
 wheel with 14 dichroic colours + open
 Variable dimmer from 0 to 100%
 DMX mode: 5 and 12 channels
 Synchronised shows (internal microphone)
 Master / Slave mode
 Drop-down menu display to assign and select different modes
 Amplitude: 540° pan - 270° tilt
 Power consumption: 194.5 W maximum
 Power supply: AC 100/230V - 50/60Hz
 Dimensions: 279 x 225 x 401 mm
 Net weight: 9.2 Kg



CASE for 4x BT-TRACKER

Flight case for 4x BT-TRACKER.

Code : B03264

519€^{Incl. VAT}



LED EFFECT MOVING HEADS

BEAM WIZARD5x5
Moving head with 5x5 15W RGBW LEDs

Code : B04417 1599€incl. VAT



25 15W RGBW (5 x 5) LED sources
4° opening per lens
Infinite PAN and TILT rotation
Light: 29700 LUX at 5m
Colour Preset and Macro
Patterns: letters, digits and figures with customisable colours
Automatic or musical programmes
Strobe, pulse effect and random strobe
Electronic dimmer variable from 0 to 100%
DMX mode: 12, 18, 110 and 116 channels
Ethernet port: Art-NET
Drop-down menu display to assign and select different modes
Amplitude: 630° pan - 270° tilt
DMX IN / OUT by XLR 3/5-pin plugs
POWER IN / OUT by Powercon plugs
Ethernet IN/OUT by RJ45
Power consumption: 420W maximum
Power supply: AC 100/230V - 50/60Hz
Dimensions: 583 x 481 x 352 mm
Net weight: 18.6 Kg



CASE FOR BEAM WIZARD5x5
Flight case for 2x BT-BEAM WIZARD

Code : B03256 569€incl. VAT



LED EFFECT MOVING HEADS

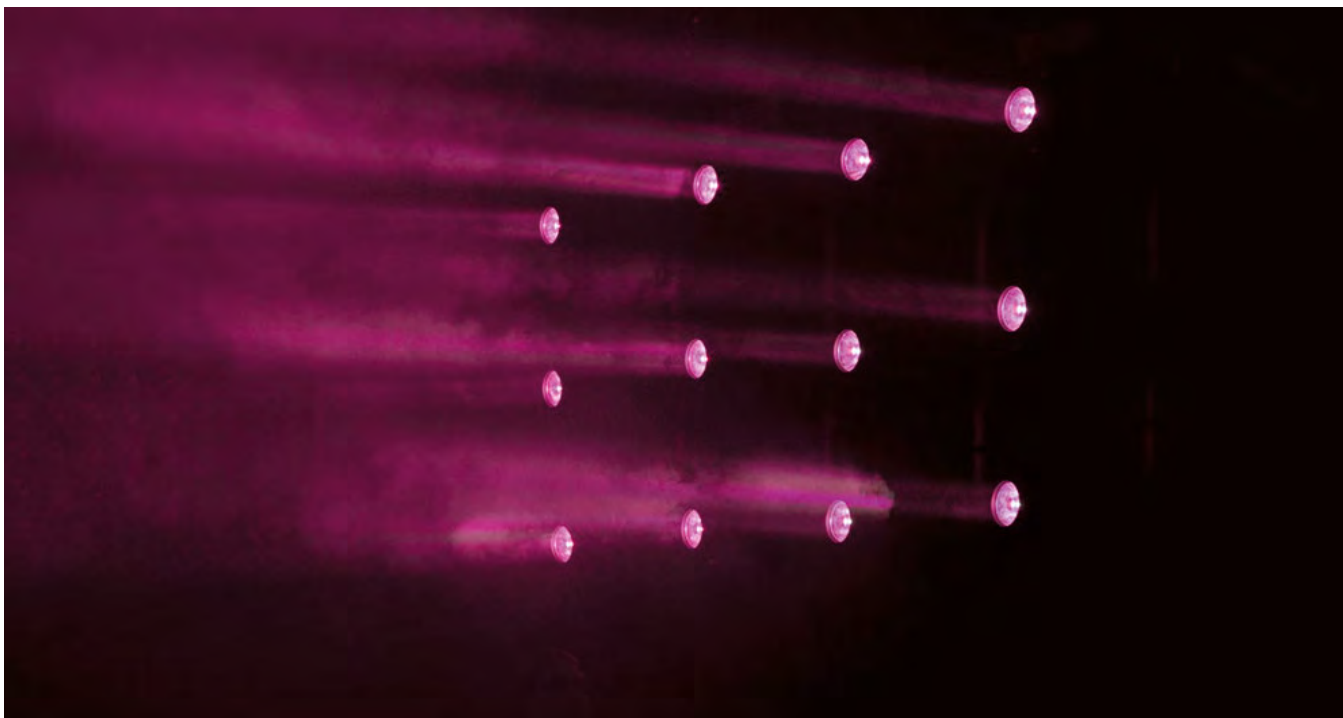

The combination of a 60W RGBW led and a very efficient collimator optic 4° lens results in an extremely powerful single beam projector.

Thanks to its endless possibilities you can create astonishing light shows!



60 W RGBW COB LED source
 4° opening (10° and 45° filters included)
 Infinite PAN and TILT rotation
 Light: 5280 LUX at 5m at 4°
 Colour Preset and Macro
 Automatic or musical programmes
 Strobe, pulse effect and random strobe
 Electronic dimmer variable from 0 to 100%
 DMX mode: 16 and 18 channels
 Drop-down menu display to assign and select different modes
 Amplitude: 540° or 630° pan - 270° tilt
 DMX IN / OUT by XLR 3/5-pin plugs
 POWER IN / OUT by Powercon plugs
 Power consumption: 80W maximum
 Power supply: AC 100/230V - 50/60Hz
 Dimensions: 304 x 236 x 186 mm
 Net weight: 5.3 Kg

BEAM FURY-1

Moving head with 60W RGBW LED and continuous rotation

Code : B04394

649€^{Incl. VAT}



CASE for 6x BEAM FURY-1

Flight case for 6x BEAM FURY-1

Code : B03265

449€^{Incl. VAT}



MOVING HEAD COMPARISON

Hybrid Beam/Spot/Wash

REF	Name	Brand	Source	Program Auto	CMY	Color wheel	Interchangeable rotating gobos	Fixed gobos	Rotating circular prism
B04378	BTX-TITAN	Briteq	HRI280 280W	-	-	13 colors [CTO + CTB]	9 gobos	14 gobos	8 facets cumulable
B04428	BTX-Saturn	Briteq	LED 270W	-	yes	9 colors [CTO + CTB + UV]	7 gobos	9 gobos	3 facets
B05528	CHALLENGER BSW	JB Systems	LED 150W	yes	-	8 colors	6 gobos	7 gobos	3 facets

Beam moving head

REF	Name	Brand	Source	Beam angle	Auto Program	Color wheel	Gobos	Rotating circular prism
B04387	BT-TRACKER	Briteq	HRI-100 100W	3°	sound	14 colors	15 gobos	8 facets

Spot moving head

REF	Name	Brand	Source	Beam angle	Dongle wifi B04645	Program auto	Color wheel	Interchangeable rotating gobos
B04398	BTX-HAWK	Briteq	LED 180W	12°	yes	yes	7 colors	7 gobos
B04384	BT-METEOR	Briteq	LED 100W	12° à 16°	yes	yes	8 colors	6 gobos
B05506	CLUBSPOT	JB Systems	LED 35W	12°	yes	yes	7 colors	-

Wash / Beam moving head

REF	Name	Brand	LED source	Beam angle	Dongle wifi B04645	IR remote	Auto program	Macro PAN / TILT	Colour wheel
	BTX-CIRRUS	Briteq	19x30W RGBW	4° à 60°	-	-	-	-	-
B04423	BT-ORBIT	Briteq	19x15W RGBW	10° à 60°	yes	-	-	-	-
B04371	BT-W30FC Mk2	Briteq	3x10W RGBW	25°	-	-	yes	yes	-
B05529	CLUBWASH 2	JB Systems	12x12W RGBWA+UV	25°	yes	-	yes	-	-
B05505	CLUBWASH	JB Systems	7x12W RGBWA+UV	25°	yes	-	yes	-	-
B05530	CLUBWASH MINI	JB Systems	4x12W RGBWA+UV	25°	-	yes	yes	-	-
B04190	STRIKER	JB Systems	30W White 6x8W RGBW	10° spot	yes	-	yes	yes	7 colors

Effect LED moving head

REF	Name	Brand	LED source	Beam angle	Continuous Pan/Tilt rotation	Art-NET	Program Auto	Multi zones pixel	Motorized zoom
B04417	BEAM WIZARD5x5	Briteq	25x15W QC	25x 4,5°	yes	yes RJ45 IN/OUT	yes	25	-
B04394	BEAM FURY-1	Briteq	60W	4°-10°45°	yes	-	-	-	-

Linear rotating prism	Iris	Frost	Zoom Beam - Spot	Focus	DMX channels	Battery	DMX XLR	Power supply	Weight	Flight case
6 facets cumulable	-	Linear	2,7° à 23°	yes	16-24-25	yes	3 et 5 points	Powercon IN - OUT	22Kg	B03251
-	yes	Linear	8° à 45°	yes	25	-	3 et 5 points	Powercon TRUE1 IN - OUT	22,7 kg	B03291
-	-	-	2° à 28°	yes	5-17-20	-	3 et 5 points	Powercon IN - OUT	12,3 kg	B03295

DMX channels	DMX XLR	Power supply	Weight	Flight case
5-12	3 points	Powercon IN - OUT	9,7Kg	B03264

Fixed gobos	Rotating circular prism	Linear Prism	Frost	Focus	Channels DMX	Battery	DMX XLR	Power supply	Weight	Flight case
9 gobos	3 facets	yes	yes	motorized	5-13-15	yes	3 et 5 points	Powercon IN - OUT	15,5Kg	B03263
-	3 facets	-	-	motorized	5-11-14	-	3 points	Powercon IN - OUT	8,75Kg	B03255
7 gobos	-	-	-	manual	5-8-11	-	3 points	IEC IN	3,5kg	B03267

Gobo wheel	Multi zones pixel	Motorized Zoom / Focus	Channels DMX	DMX XLR	Power supply	Weight	Flight case
-	19	Zoom	20-96	3 et 5 points	Powercon TRUE1 IN - OUT	16,5 kg	B03288
-	3	Zoom	14a-14b-27	3 et 5 points	Powercon IN - OUT	9,2Kg	B03272
-	-	-	1-4-1-9-16	3 points	IEC IN - OUT	4,2Kg	B03225
-	-	-	5-9-15	3 points	IEC IN	3,5 kg	B03296
-	-	-	5-9-15	3 points	IEC IN	3 kg	B03267
-	-	-	5-9-15	3 points	IEC IN	1,6 kg	-
7 gobos	Spot / Wash	Focus	5-19	3 points	IEC IN	4,5Kg	B03267

Number of dmx channels	Battery	DMX XLR	Power supply	Weight	Flight case
12-18-110-116	yes	3 et 5 points	Powercon IN - OUT	20Kg	B03256
12-14	yes	3 et 5 points	Powercon IN - OUT	6,2Kg	B03265



ANIMATION EFFECTS

NEW



RAVE BAR
LED Bar with 14x3W + 300 SMD LED

Code : B06208 339€^{Incl. VAT}



NEW



SUNBAR COMBI
Light bar 7x3W WW + 7x9W RGB LEDS

Code : B06207 259€^{Incl. VAT}



NEW



SUNBAR WHITE
Light bar 10x3W LED WW 7°beams, L=1m

Code : B06206 209€^{Incl. VAT}



NEW



CASE FOR 4 EFFECT BARS 1M
JV Case Flightcase for 4 effect bars like Sunbar White or Combi, Rave Bar

Code : B03294 379€^{Incl. VAT}



14x3W Warm White Leds
120 SMD RGB Leds
180 SMD Cold White Leds
Compatible WTR-DMX DONGLE.
DMX-control: via 1, 2, 6, 34 or 37 channels
Music mode
Master/slave4

7x3W warm white LEDs with individual pixel control + 7x9W RGB Leds.
Full DMX-control via 1, 4, 11, 12 or 17 channels.
Sound mode.
Compatible WTR-DMX DONGLE.

10x3W warm white LEDs and pixel control.
DMX control via 1, 3, 5, 10 or 15 channels.
Control each pixel manually or use one of the 17 integrated automatic programs.
Sound mode.
Master/slave mode for bigger setups.
Compatible WTR-DMX DONGLE.10x3W warm white LEDs and pixel control.

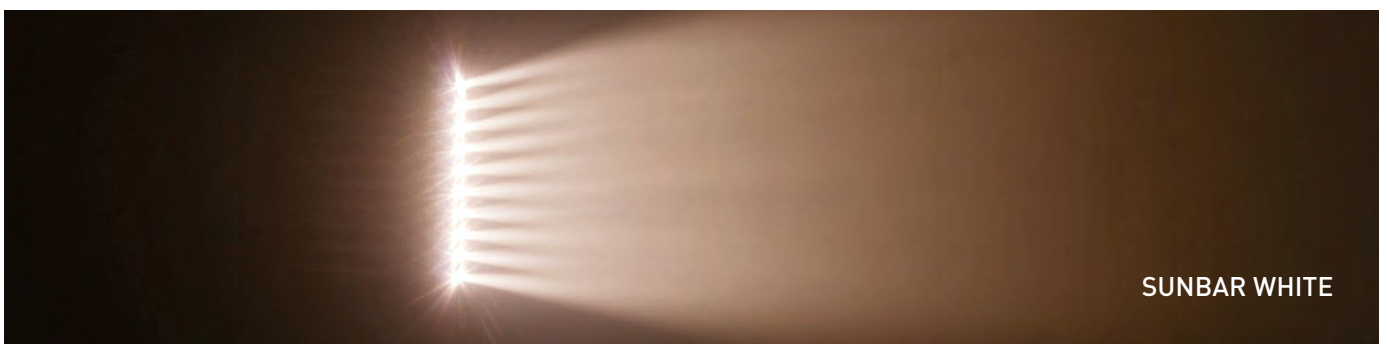

ANIMATION EFFECTS



LED GLOBE

Rotating effect with 98 beamls. 5x 2W RGBW LED

Code : B06202 199€^{Incl. VAT}



Power supply: 100 to 240 V AC, 50/60Hz
Fuse: 250 V 1.6A slow-blow (20 mm glass)
Total consumption: 60 w
Sound control: Internal microphone
DMX connections: XLR 3-pin male/female
No. of DMX channels: 1, 3, 9 or 19 channels
LED power: 5 RGB LEDs + White 8 W
Dimensions: 397 x 397 x 397 x 510mm
Weight: 4,23kg
Wireless DMX: WTR-DMX dongle (optional)

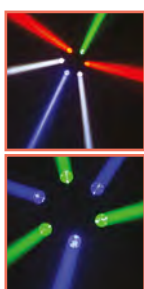

LED HELICOPTER

Rotating effect with 6x RGBW projectors

Code : B06203 159€^{Incl. VAT}



Power supply: 100 to 240 V AC, 50/60Hz
Fuse: Slow fuse 250 V T1.6 A (20 mm glass) Total consumption: 60W
Sound control: Internal microphone
DMX connections: XLR 3-pin male/female
No. of DMX channels: 3 or 11 channels
PAR projector power: 6 projectors with 8 W RGBW LED
Beam angle: 7°
Dimensions: 390x360x360x240 mm
Weight: 4,16kg
Wireless DMX: WTR-DMX dongle (optional)



HEXAGON 3D

3D Hexagonal RGB wall mirror effect

Code : B06205 149€^{Incl. VAT}



Power supply: 100 to 240 V AC, 50/60Hz
Fuse: Slow fuse 250 V 2 A (glass 20 mm)
Maximum power consumption: 50 W
Sound control: Internal microphone
DMX connections: XLR 3-pin male/female
No. of DMX channels: 3 and 9 channels

LED: 72 x red-green-blue LED 1.5 W
Dimensions: 404 x 352 x 97 mm
Weight: 3.2 kg



DYNABARREL

LED effect with rotating mirror

119€^{Incl. VAT}

Code : B04187



10W RGBW LED source
manual focus
DMX mode: 1 or 9 channels
Synchronised shows (internal microphone)
Simplified control: CA8 compatible
Master / Slave mode
DMX IN / OUT by XLR 3-pin plugs POW-ER IN / OUT by IEC plugs
Power supply: AC 100/230V - 50/60Hz
Dimensions: 331 x 170 x 120 mm
Net weight: 2.95 Kg



PIXEL PIPE

RGB LED tube 1m with DMX and IR remote

99€^{Incl. VAT}

Code : B06204



Power supply: 100-240 V AC, 50/60 Hz
Power consumption: 12 W

Power interconnection (IEC input/output)
: maximum link load = 6 A
Sound control: Internal microphone

DMX connections: 3-pin male/female
XLR male to female
DMX mode: 3, 7, 24 DMX channels
LED light source: 32 RGB LED SMD5050
Dimensions: 105 x 20 x 20 x 22 cm
Weight: 1.24 kg

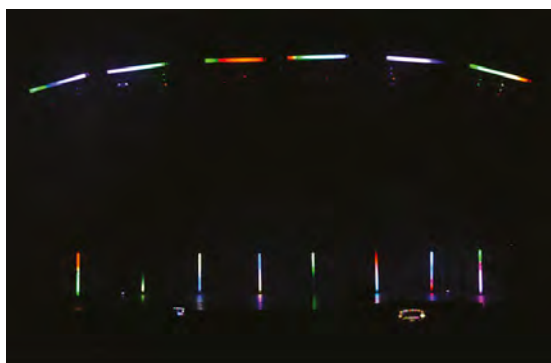

ANIMATION EFFECTS



ORION
LED effect

Code : B04143 99€^{Incl. VAT}



4 groups with a total of 224 LEDs
(80 red, 60 green, 48 blue, 36 white)
Synchronised shows (internal microphone)
Automatic or musical programmes
Master / Slave mode
DMX control: 1, 4 and 7 channels
Simplified control (CA-8 compatible)
Drop-down menu display to assign and select different modes
DMX IN / OUT by XLR 3-pin plugs POWER IN / OUT by IEC plugs
Power consumption: 30 W max.
Power supply: AC 100/230V - 50/60Hz
Dimensions: 475 x 290 x 160 mm
Net weight: 5.3 kg





ALIEN
LED effect + UV + stroboscope + laser

Code : B06200 239€^{Incl. VAT}

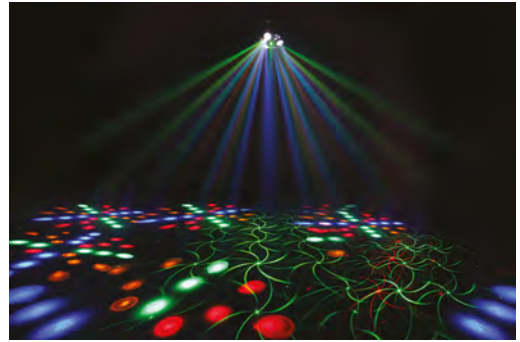

3 projectors with 9 8 W RGB+UV LEDs
Effect with 84 0.75 W RGBA LEDs
Stroboscopic: 12 0.5 W white LEDs
Laser: red (100 mW) and green (30 mW)
laser motifs
IR remote control included
Synchronised shows (internal microphone)
Automatic or musical programmes
Master / Slave mode
DMX control: 3, 9, 11 or 28 channels
Drop-down menu display to assign and select different modes
DMX IN / OUT by XLR 3-pin plugs POWER IN / OUT by IEC plugs
Power consumption: 66 W max.
Power supply: AC 100/230V - 50/60Hz
Dimensions: 830 x 171 x 202 mm
Net weight: 5 kg



SUPER LED RAINBOW
Powerful multibeam LED effects

Code : B04171 299€^{Incl. VAT}



6 10W RGBW LED sources
Beam opening 9° per lens
Synchronised shows (internal microphone)
Automatic or musical programmes
Master / Slave mode
DMX control: 1, 8 or 28 channels
Simplified control (CA-8 compatible)
Drop-down menu display to assign and select different modes
DMX IN / OUT by XLR 3-pin plugs POWER IN / OUT by IEC plugs
Power consumption: 80.6W max.
Power supply: AC 100/230V - 50/60Hz
Dimensions: 418 x 233 x 122 mm
Net weight: 4.18 kg



SUPER QUADRA BEAM
Extremely dynamic scanning LED

Code : B04180 149€^{Incl. VAT}



4 groups of 9 pcs 1W LEDs
(8 x red, 8 x green, 8 blue, 12 x white)
Synchronised shows (internal microphone)
Automatic or musical programmes
Master / Slave mode
DMX control: 1 or 3 channels
Simplified control (CA-8 compatible)
Drop-down menu display to assign and select different modes
DMX IN / OUT by XLR 3-pin plugs POWER IN / OUT by IEC plugs
Power consumption: 66 W max.
Power supply: AC 100/230V - 50/60Hz
Dimensions: 830 x 171 x 202 mm
Net weight: 5 kg



SUPER ORION
Extremely dynamic scanning LED effect

Code : B04179 139€^{Incl. VAT}



4 groups of 9 pcs 1W LEDs
(8 x red, 8 x green, 8 blue, 12 x white)
Synchronised shows (internal microphone)
Automatic or musical programmes
Master / Slave mode
DMX control: 1 or 3 channels
Simplified control (CA-8 compatible)
Drop-down menu display to assign and select different modes
DMX IN / OUT by XLR 3-pin plugs POWER IN / OUT by IEC plugs
Power consumption: 67 W max.
Power supply: AC 100/230V - 50/60Hz
Dimensions: 430 x 256 x 172 mm
Net weight: 4.1 kg



ANIMATION EFFECTS



PARTY DERBY

Compact projector with 2 different led effects

Code : B04186 95€^{incl. VAT}



INVADER

Multieffect: 23W LED eff. + 200mW red+green laser

Code : B04176 219€^{incl. VAT}



LED VIRTUAL FLAME

Flame simulator 36cm diameter

Code : B04544 99€^{incl. VAT}



Derby LED effect
Stroboscopic: 16 white LEDs
IR remote control included
Synchronised shows (internal microphone)
Automatic or musical programmes
Master / Slave mode
DMX control: 1 or 5 channels
Drop-down menu display to assign and select different modes
DMX IN / OUT by XLR 3-pin plugs POWER IN / OUT by IEC plugs
Power consumption: 28 W max.
Power supply: AC 100/230V - 50/60Hz
Dimensions: 190 x 258 x 182 mm
Net weight: 1.72 kg

Effect with 5 3 W RGBWA LEDs
Stroboscopic: 8 1 W white LEDs
Laser: red (150 mW) and green (50 mW) laser motifs
Synchronised shows (internal microphone)
Automatic or musical programmes
Master / Slave mode
DMX control: 1 or 9 channels
Drop-down menu display to assign and select different modes
DMX IN / OUT by XLR 3-pin plugs POWER IN / OUT by IEC plugs
Power consumption: 66 W max.
Power supply: AC 100/230V - 50/60Hz
Dimensions: 240 x 220 x 110 mm
Net weight: 3.75 kg

Equipped with 5 1W LED light emitting diodes
The nearly silent fan allows a flame to be projected to a height of about 35 cm
Place it on a flat surface or hang it with the set of fine mesh chains provided.
Diameter of the fire cup: 36 cm
Power consumption: 16.5W max.
Power supply: AC 100/230V - 50/60Hz
Net weight: 3.55 kg



BEAMSPOT-4BAR NW

T-BAR with 4 BEAMSPOT NW 4500K

Code : B05508 449€^{incl. VAT}



BEAMSPOT-4BAR WW

T-BAR with 4 BEAMSPOT WW 3200K

Code : B05507 449€^{incl. VAT}



CASE FOR 4x BEAMSPOT-4BAR

Flight case for 4 x Beamspot-4Bar

Code : B03275 459€^{incl. VAT}



4 white 15W 4500K LED sources
4° opening [10° and 45° filters included]
Electronic dimmer from 0 to 100%
2 Mode dimmer: Slow, Fast
4 Dimmer curves [LINEAR, SQUARE, INV.SQUARE, S-CURVE]
DMX mode: 1, 2, 4 or 5 channels
Wireless DMX: WTR-DMX dongle (optional)
Drop-down menu display
DMX IN / OUT by XLR 3/5-pin plugs
POWER IN / OUT by PowerCON plugs
Spigot support 28mm
Power supply: AC 100/230V - 50/60Hz
Dimensions: 552 x 85 x 315 mm
Net weight: 6.74 Kg

4 15W Warm white 3200K LED sources
4° opening per lens (10° and 45° filters included)
Electronic dimmer variable from 0 to 100%
2 Mode dimmer: Slow (halogen), Fast (LED)
4 Dimmer curves [LINEAR, SQUARE, INV.SQUARE, S-CURVE]
DMX mode: 1, 2, 4 or 5 channels
Wireless DMX: WTR-DMX dongle (optional)
Drop-down menu display to assign and select different modes
DMX IN / OUT by XLR 3/5-pin plugs
POWER IN / OUT by PowerCON plugs
Spigot support 28mm
Power consumption: 71W max.
Power supply: AC 100/230V - 50/60Hz
Dimensions: 552 x 85 x 315 mm
Net weight: 6.74 Kg



ANIMATION EFFECTS



SUPER BOOGIE

Double Led Flower DMX

Code : B04178 79€^{Incl. VAT}



SUPER ATLAS

Flower LED 9 x 1Watt

Code : B04177 49€^{Incl. VAT}



LED DIAMOND II

A LED projector controlled by very attractive and compact DMX

Code : B04188 45.90€^{Incl. VAT}

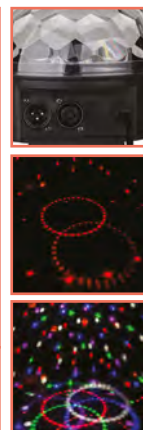

Equipped with 2 sets of 9 1 Watt LEDs (4 x red, 4 x green, 4 blue, 6 x white)
Synchronised shows (internal microphone)
Automatic or musical programmes
Master / Slave mode
DMX control: 1 or 3 channels
Simplified control (CA-8 compatible)
Drop-down menu display to assign and select different modes
DMX IN / OUT by XLR 3-pin plugs POWER IN / OUT by IEC plugs
Power consumption: 35 W max.
Power supply: AC 100/230V - 50/60Hz
Dimensions: 246 x 230 x 164 mm
Net weight: 2.6 kg

Equipped with 9 1 Watt LEDs (2 x red, 2 x green, 2 blue, 3 x white)
Automatic programmes (internal microphone)
Consumption: 20 W max.
Power supply: AC 100/230V - 50/60Hz
Dimensions: 141 x 224 x 203 mm
Net weight: 1.4 kg

6 3W LED sources (1 red + 1 green + 1 blue + 1 white + 1 orange + 1 violet)
The various lenses project many beams of clean colour over more than 360 degrees
Synchronised shows (internal microphone)
Automatic or musical programmes
Master / Slave mode
DMX control: 1 or 6 channels
Drop-down menu display to assign and select different modes
DMX IN / OUT with 3-pin plugs
Power consumption: 24 W max.
Power supply: AC 100/230V - 50/60Hz
Dimensions: dia 190 x 175 mm
Net weight: 0.42 kg



PARTY BAR

The PARTY BAR is a fabulous set of 4-in-1 lights for mobile DJs!

Code : B04184 349€^{Incl. VAT}



2 Derby effects equipped with a 3 W RGB LED
2 projectors with 3 RGB 9 W LEDs
4 cool white LEDs to create stroboscopic effects
The bi-colour red/green laser
IR remote control included
Synchronised shows (internal microphone)
Automatic or musical programmes
Master / Slave mode
DMX control: 3, 5, 6, 9 or 27 channels
Wireless DMX: WTR-DMX dongle (optional)
Drop-down menu display to assign and select different modes
DMX IN / OUT by XLR 3-pin plugs POWER IN / OUT by IEC plugs
Power consumption: 48 W max.
Power supply: AC 100/230V - 50/60Hz
Dimensions: 1185 x 386 x 110 mm
Net weight: 8.35 kg

The PARTY BAR is a fabulous 4in1 lighteffect

This extremely compact bar is stuffed with 4 different light effects to create a wonderful lightshow:

- 2 rotating Derby effects, each equipped with Red, Green and Blue 3 watt LEDs
- 2 LED projectors, each equipped with 3pcs 9 watt RGB LEDs for strong 15° beams
- 4 Cold white LEDs to create all kinds of strobe and blinder effects

The 2 color red/green laser projects hundreds of thin beams for a stunning atmosphere

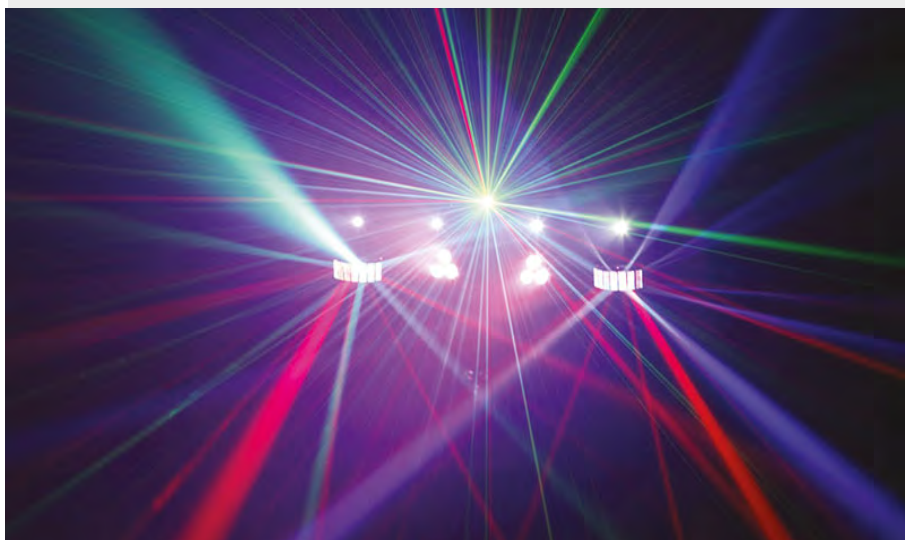



PARTY BEAMS

This extremely compact bar is equipped with two different light effects to create superb light effects

Code : B04185 99€^{Incl. VAT}



LED POLICE LIGHT BLUE

Blue LED rotating beacon

Code : B04540 26.90€^{Incl. VAT}



LED POLICE LIGHT RED

Red LED rotating beacon

Code : B04541 26.90€^{Incl. VAT}



LED SIXLIGHT

6-channel chaser with integrated microphone

Code : B04538 55.90€^{Incl. VAT}



8 9W RGB LED sources
Beam opening 7° per lens + 4 White 1W LEDs (stroboscope)
Pre-programmed shows, Colour control and stroboscopic LEDs
Electronic dimmer variable from 0 to 100%
Master / Slave mode
DMX mode: 3, 9 or 14 channels
DMX IN / OUT by XLR 3-pin plugs POWER IN / OUT by IEC plugs
Power consumption: 76W max.
Power supply: AC 100/230V - 50/60Hz
Dimensions: 605 x 184 x 268 mm
Net weight: 3.2 kg

Rotating beacon with 108 extremely brilliant LEDs
Adjustable rotation speed
Weight: 0.86 Kg
Dimensions: dia 143 x 182 mm
AC 240V - 50Hz / 12 V DC adaptor supplied

Rotating beacon with 108 extremely brilliant LEDs
Adjustable rotation speed
Weight: 0.86 Kg
Dimensions: dia 143 x 182 mm
AC 240V - 50Hz / 12 V DC adaptor supplied

6 channel chaser
Equipped with 282 LEDs (47 red, 47 green, 94 blue, 47 orange and 47 yellow)
Modular: possibility of changing the shape of the device
Integrated microphone
Adjustable speed and audio sensitivity
Weight: 2.1 Kg
Dimensions: 365 x 347 x 182 mm
AC 240V - 50Hz / 14 V DC adaptor supplied

BLACK LIGHT



LED UV-GUN 100W

UV projector with 100W "COB" LED

Code : B03807 429€^{Incl. VAT}



UV 100W COB LED on individual reflector
Beam angle: 100°
DMX IN/OUT by XLR 3
4-digit display with drop-down menu IR remote control for:
Dimmer, Strobe, audio mode, Master/Slave
Regulated fan cooling
Power supply: AC 100/240V - 50/60Hz
Dimensions: 263 x 309 x 300 mm
Net weight: 4.1 Kg



LED UV-BAR 9

Black light- 9x 3Watt LEDs

Code : B06209 39€^{Incl. VAT}



A compact LED-based black light effect for all your parties
Aluminum housing
9x 3Watt LEDs
No fragile, easy breakable lamps
Lightweight
Plug & play: no difficult controls!
A compact LED-based black light effect for all your parties
Aluminum housing
9x 3Watt LEDs
No fragile, easy breakable lamps
Lightweight
Plug & play: no difficult controls!



LASERS



BT-LASER1500 RGB

1.5 W - R:500 mW - G:200 mW - B:800 mW

Code : B04235 999€^{Incl. VAT}



Superb 1.5Watt Class IV laser
Incorporates 3 powerful coloured lasers (RVB):
Red laser 500 mW (638 nm)
Green laser 200 mW (532 nm)
Blue laser 800 mW (450 nm)
20Kpps scanners for clean, flawless RGB images!
100% ILDA compatible for maximum flexibility in use!
SD card reader to project your own motifs and logos.
6 user modes
CONTROLLED BY THE MUSIC
MASTER/SLAVE
AUTOMATIC
DMX mode: 1 or 13 channels
ILDA mode
SD CARD mode
Power consumption: 45W max.
Power supply: AC 100/230V - 50/60Hz
Dimensions: 300 x 240 x 160 mm
Net weight: 7.8 kg
Meets EN/IEC 60825-1 Ed2, 2007-03 safety standards with respect to lasers



MULTIBEAM LASER

850 mW - 2xR: 150 mW - G: 50 mW - B: 500 mW

Code : B04236 339€^{Incl. VAT}



RGRB White Class 3B 850 mW laser equipped with 4 powerful temperature controlled lasers:
2 150 mW red lasers (650 nm)
1 50 mW green laser (532 nm)
1 500 mW blue laser (450 nm)
4 user modes:
Musical mode: 100% plug&play
MASTER/SLAVE mode
AUTOMATIC mode
DMX mode: 2 or 10 channels
Infrared remote control included
LED display to facilitate navigation in the configuration menu
Power consumption: 65W max.
Power supply: AC 100/230V - 50/60Hz
Dimensions: 537 x 268 x 170 mm
Net weight: 5 kg
Meets EN/IEC 60825-1 Ed2, 2007-03 safety standards with respect to lasers



RADIANT LASER

240 mW - G: 40 mW - B: 200 mW

Code : B04222 329€^{Incl. VAT}



Class 3B Laser with one green 40mW 532nm laser and one blue 200mW 450nm laser.
Several modes are available:
DMX mode: 1 or 10 channels
Standalone mode: sound activated (via internal microphone) or automatic mode
Master/Slave mode
Simplified control (CA-8 compatible)
Compatible with RF-DMX Converter:
3-character LED screen for easy navigation through the menus.
Power consumption: 30W max.
Power supply: AC 100/230V - 50/60Hz
Dimensions: 250 x 240 x 190 mm
Net weight: 2.92 kg
Meets EN/IEC 60825-1 Ed2, 2007-03 safety standards with respect to lasers

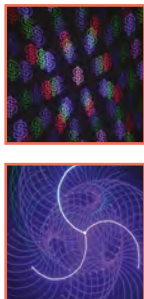

SPECTRA-3D Laser

480 mW - R:100 mW - G:80 mW - B:300 mW

Code : B04230 599€^{Incl. VAT}



RGB Class III 480mW laser
25Kpps scanners combined with 4 effect wheels, Motifs and 3D effect shows, 80 motifs and RGB beams, burst effects... ILDA compatible for maximum use flexibility!
User modes:
MASTER/SLAVE STANDALONE: automatic and sound DMX mode: 1, 2 or 19 channels ILDA mode
Power consumption: 40W max.
Power supply: AC 100/230V - 50/60Hz
Dimensions: 290 x 240 x 110 mm
Net weight: 4.16 kg
Meets EN/IEC 60825-1 Ed2, 2007-03 safety standards with respect to lasers



LOUNGE LASER DMX

190 mW R: 150 mW - G: 40 mW

Code : B04221 149€^{Incl. VAT}



190mW laser with one green 40mW laser and one 150mW red laser + blue LED projector with waterwave style!
Several modes are available:
DMX mode: 1 or 7 channels
Standalone mode: sound activated (via internal microphone) or automatic mode
Master/Slave mode
3-digit LED display for simple navigation of the menus
Power consumption: 15W max.
Power supply: AC 100/230V - 50/60Hz
Dimensions: 233 x 165 x 200 mm
Net weight: 1.9 kg
Meets EN/IEC 60825-1 Ed2, 2007-03 safety standards with respect to lasers



SPACE-4 Laser

G: 40mW

Code : B04232 119€^{Incl. VAT}



Green 40mW Class 3B compact laser
Several modes are available:
DMX mode: 1 or 8 channels
Standalone mode: sound activated (via internal microphone) or automatic mode
Infrared remote control included
Master/Slave mode
3-digit LED display for simple navigation of the menus
Power consumption: 12W max.
Power supply: AC 100/230V - 50/60Hz
Dimensions: 145 x 160 x 80 mm
Net weight: 1.48 kg
Meets EN/IEC 60825-1 Ed2, 2007-03 safety standards with respect to lasers

LASERS



SMOOTH SCAN-3 Laser

140 mW - G: 100 mW - V: 40 mW

Code : B04226 209€^{Incl. VAT}



LASER INTERLOCK SWITCH

Emergency stop mushroom button for Laser

Code : B04210 27€^{Incl. VAT}



µ-QUANTUM Laser

180 mW - R: 100 mW - B: 80 mW

Code : B04228 69€^{Incl. VAT}



Class 3B Laser based on one green 40mW 532nm laser and one red 100mW 650nm laser.
Fluid movements, 80 motifs, numbers, designs, words, etc....
Several modes are available:
DMX mode: 1 or 17 channels
Standalone mode: sound activated (via internal microphone) or automatic mode
Infrared remote control included
Master/Slave mode
3-digit LED display for simple navigation of the menus
Power consumption: 13W max.
Power supply: AC 100/230V - 50/60Hz
Dimensions: 190 x 170 x 80 mm
Net weight: 1.61 kg
Meets EN/IEC 60825-1 Ed2, 2007-03 safety standards with respect to lasers

This emergency switch is additional safety for your laser projector.

Laser using one red 100mW 650nm laser and one blue 80mW 450nm laser
Plug-and-Play: no controller necessary!
Infrared remote control included
Standalone mode with integrated microphone or automatic shows mode.
Stroboscopic effect available
Adjustable support and AC adaptor included.
Power consumption: 5.7 W max.
Power supply: AC 100/230V - 50/60Hz
Dimensions: 117 x 92 x 46 mm
Net weight: 0.64 kg
Complies with EN/IEC 60825-1 Ed2, 2007-03 standards concerning Laser Safety



µ-QUASAR Laser

140 mW - G: 40 mW - R: 100 mW

Code : B04225 59€^{Incl. VAT}

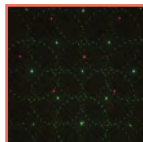

µ-STAR Laser

140 mW - G: 40 mW - R: 100 mW

Code : B04224 49€^{Incl. VAT}



Laser using one red 100mW 650nm laser and one green 40mW 532nm laser
Plug-and-Play: no controller necessary!
Infrared remote control included
Standalone mode with integrated microphone or automatic shows mode.
Stroboscopic effect available
Adjustable support and AC adaptor included.
Power consumption: 5.7 W max.
Power supply: AC 100/230V - 50/60Hz
Dimensions: 117 x 92 x 46 mm
Net weight: 0.64 kg
Complies with EN/IEC 60825-1 Ed2, 2007-03 standards concerning Laser Safety

Laser using one red 100mW 650nm laser and one green 40mW 532nm laser
Plug-and-Play: no controller necessary!
Infrared remote control included
Standalone mode with integrated microphone or automatic shows mode.
Stroboscopic effect available
Adjustable support and AC adaptor included.
Power consumption: 5.7 W max.
Power supply: AC 100/230V - 50/60Hz
Dimensions: 117 x 92 x 46 mm
Net weight: 0.64 kg
Complies with EN/IEC 60825-1 Ed2, 2007-03 standards concerning Laser Safety



STROBES



BT-GIGAFLASH

Strobe LED with 9 separately controllable segments and a light output of +/- 100 000 lm.

Code : B04714

889€Incl. VAT



1260 4500°K LEDs source
9 independent sections frequency from 0 to 30 Hz and Blinder mode
Flicker free
7 different DMX modes with 1 to 13 channels
LCD display with drop-down menu
Reflector shutters for more rendering
DMX 3 and 5 XLR
Powercon In and Out
Forced and regulated ventilation
Power supply: 240V/50Hz 900 W max
Dimensions: 471 x 195 x 274 mm
Weight: 8.5 kg



BT-MAGICFLASH RGB

Colour LED strobe with 3 separately controllable segments and 324 RGB strobe LEDs

Code : B04717

449€Incl. VAT



324 RGB LEDs source
3 independent sections frequency from 0 to 30 Hz and Blinder mode
Flicker free
7 different DMX modes with 1 to 13 channels
LCD display with drop-down menu
DMX XLR 3
Powercon In and Out
Forced and regulated ventilation
Power supply: 240V/50Hz 140 W max
Dimensions: 336 x 126 x 212 mm
Weight: 4.0 kg



BT-MAGICFLASH

Powerful LED strobe with 9 separately controllable segments and a light output of +/- 35,000 lm.

Code : B04715

379€Incl. VAT



324 4500°K LEDs source
9 independent sections frequency from 0 to 30 Hz and Blinder mode
Flicker free
7 different DMX modes with 1 to 13 channels
LCD display with drop-down menu
DMX XLR 3
Powercon In and Out
Forced and regulated ventilation
Power supply: 240V/50Hz 250 W max
Dimensions: 336 x 126 x 212 mm
Weight: 4.0 kg



BT-STROBE 1500

A powerful 1,500 W professional strobe, 2 DMX channels with intense light output.

Code : B04713

159€Incl. VAT



1500W Xenon lamp source
Variable frequency and effects
Adjustment of speed and dimmer by potentiometer
2 DMX channels (speed and dimmer)
DMX XLR 3
Input Jack for CA-8 controller
Power supply: 240V/50Hz
Dimensions: 458 x 147 x 116 mm
Weight: 3.58 kg



MIRROR BALLS



MIRROR BALL 20/50 cm
Mirror ball 20"/50 cm

Code : B02026 70.90€^{Incl. VAT}



MIRROR BALL 16/40 cm
Mirror ball 16"/40 cm

Code : B02024 51.90€^{Incl. VAT}



MIRROR BALL 12/30 cm
Mirror ball 12"/30 cm

Code : B02023 24.90€^{Incl. VAT}



MIRROR BALL 8/20 cm
Mirror ball 8"/20 cm

Code : B02022 11.90€^{Incl. VAT}



MIRROR BALL 4/10 cm
Mirror ball 4"/10 cm

Code : B02027 4.90€^{Incl. VAT}



MB ROTATOR Heavy duty
Motor for mirror balls up to a weight of 10 kg

Code : B04123 48.90€^{Incl. VAT}



MB ROTATOR STANDARD
Mirror ball motor: 1.5 rpm.

Code : B02021 18.90€^{Incl. VAT}



MB ROTATOR BATTERY
Motor for mirror balls with a maximum diameter of 20 cm

Code : B02020 6.90€^{Incl. VAT}



CHROMATEQ®

Chromateq® offers innovative DMX lighting control solutions (lighting and multimedia) for professional architectural lighting and the entertainment world.

It is a solution adapted to all types of projects and for all sectors of activity: audio system, discos, theatres, concerts, live performances, LED installations, architectural lighting inside and outside, monuments, exhibitions and other services.

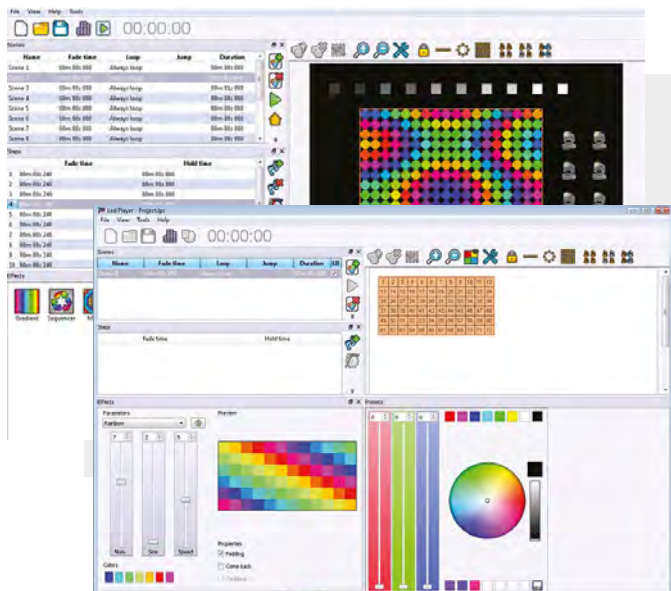

LED PLAYER

Led Player is ideal for all DMX (architectural and entertainment) applications and fixed installations. It can control all standard DMX devices and can record a show in the interfaces. The LED Player is the easiest and most economical solution for DMX lighting control.



LD-512WALL+
DMX wall controller.
For CHROMATEQ software.

Code : B05016 309€ Incl. VAT



LD-1024WALL+
DMX Interface 1024ch/4MB, white, Chromateq softw.

Code : B05017 399€ Incl. VAT



LD-512BOX
512-channel DMX interface with remote control IR
For CHROMATEQ software

Code : B05005 185€ Incl. VAT



LD-1024BOX
DMX interface with 1024 DMX channels.
For CHROMATEQ software

Code : B05006 299€ Incl. VAT



Wall interface compatible with the software " Chromateq Led Player " (provided)
512 DMX channels
4Mb internal memory expandable by SD card
Activation by external contacts
Access to 80 scenes by 8 buttons /10 pages
Direct access to the interface : Trigger, Speed, Dimmer, Color
Calendar function
Merger Mode
Operating System: Windows & MAC OSX & Linux
DMX outputs on terminal block
Power supply : By mini USB 5V or DC 9-36 V
Art-Net Universe available: 1

Wall interface compatible with the software " Chromateq Led Player " (provided)
1024 DMX channels
4Mb internal memory expandable by SD card
Activation by external contacts
Access to 80 scenes by 8 buttons /10 pages
5 zones: activate up to 5 programs simultaneously in stand-alone mode.
Direct access to the interface : Trigger, Speed, Dimmer, Color
Calendar function
Merger Mode
Operating System: Windows & MAC OSX & Linux
DMX outputs on terminal block
Power supply : By mini USB 5V or DC 9-36 V
Art-Net Universe available: 2

Compact DMX interface
Wall interface compatible with "Chromateq Led Player" software (supplied)
IR remote control
512 DMX channels
256 channels in standalone
Internal memory for max. 255 scenes
IR remote control included for:
Choice of scenes, speed, dimmer, BO
Operating system: Windows & MAC OSX & Linux
DMX outputs on XLR connectors
Power supply: By mini USB 5V (cable supplied)
Art-Net Universe available: 1

Standalone compact DMX interface
Compatible with "Chromateq Led Player" and "Chromateq Pro DMX" software. (supplied)
1024 DMX channels (2x512)
132 channels in standalone
Internal memory for max. 255 scenes
IR receiver for optional remote control
Operating system: Windows & MAC OSX & Linux
DMX Inputs and Outputs on XLR and terminal block connectors.
Power supply: By mini USB 5V (cable supplied)
Art-Net Universe available: 2



WI-LIGHT

The application can be used as a WIFI remote control with the LED Player software and LD-512WIFI interface. It can control all Live Board mode and standalone mode controls through a local WIFI connection. For smartphones and tablets.



LD-512EASY+
512-channel DMX interface with 8 buttons.
For CHROMATEQ software.

Code : B05012 329€Incl. VAT



LD-1024EASY+
DMX Interface 1024ch/4MB, XLR, Chromateq softw.

Code : B05018 419€Incl. VAT



LD-1024DIN
DMX interface 1024 channels in DIN rail format. For CHROMATEQ software

Code : B05013 329€Incl. VAT



Compact DMX interface
"Chromateq Led Player" and "Chromateq Pro DMX". (supplied)
512 DMX channels
Internal memory for max. 255 scenes
SD card slot for more memory
Activation by external contacts
Access to 80 programs by 8 buttons/10 pages
Direct access to the interface:
Trigger, Page, Colour, Speed, Dimmer
Calendar function
Splitter mode 2x512
Operating system: Windows & MAC OSX & Linux
DMX outputs on XLR connectors
Power supply: By mini USB 5V or DC 9-36 V
Art-Net Universe available: 1

Compact DMX interface
"Chromateq Led Player" and "Chromateq Pro DMX". (supplied)
1024 DMX channels
Internal memory for max. 512 scenes
SD card slot for more memory
Activation by external contacts
Access to 80 programs by 8 buttons/10 pages
Direct access to the interface:
Trigger, Page, Colour, Speed, Dimmer
Calendar function
Operating system: Windows & MAC OSX & Linux
DMX outputs on XLR connectors
Power supply: By mini USB 5V or DC 9-36 V
5 zones: activate up to 5 programs simultaneously in stand-alone mode
Art-Net Universe available: 2

Interface in DIN rail format
1024 DMX channels
Compatible with "Chromateq Led Player" and "Chromateq Pro DMX" software. (supplied)
Internal 4MB memory for storing programs.
Internal memory for max. 255 scenes
Activation by external contacts or optional remote control
Calendar function
Splitter mode 2x512
Merger mode
Chaining in Master/Slave possible
Operating system: Windows & MAC OSX & Linux
DMX inputs and outputs on connectors.
Power supply: By mini USB 5V or DC 9-36V
Art-Net Universe available: 2



LD-512KIT-IR
Infrared set for CHROMATEQ interfaces

Code : B05011 45€Incl. VAT



Infrared set including 2 wireless remotes and 1 IR receiver board that can be installed anywhere in the room. Remote controls can also be used with LD standalone interfaces already integrating an IR receiver.

PRO DMX

Professional software for experienced users and the production of quality shows. Thanks to the Timeline, it is the indispensable controller for Live performances and synchronizations in Audio, Video and lighting. Pro DMX will animate and embellish all your artistic creations easily.

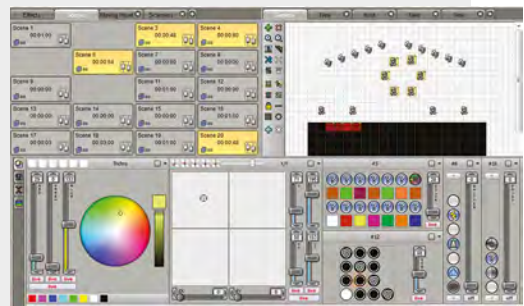

SWEETLIGHT



Software available in several languages

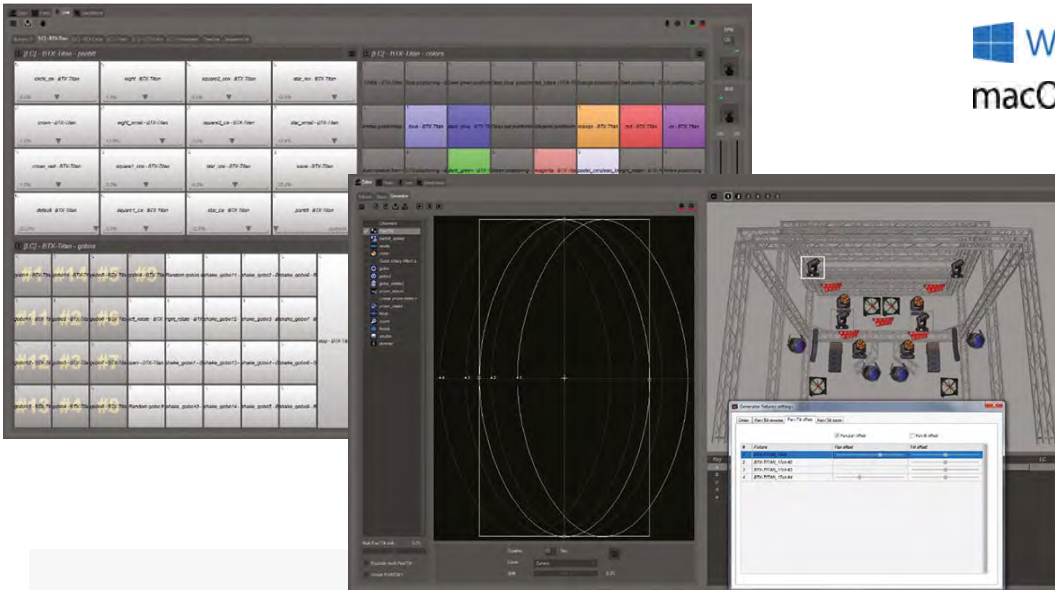

- New version V9
- New skin
- Lightshow creator
- 3DView - New 3D engine
- etc



SWEET D512S
DMX sweetlight 512ch DMX controller

Code : H10957 269€^{Incl. VAT}



SWEET D1024
Sweetlight 1024 channel box

Code : H10956 399€^{Incl. VAT}



SWEET RACK1024
1024 channel standalone interface with infrared remote control

Code : H11015 699€^{Incl. VAT}



SWEET NET512
Ethernet to dmx interface (Sweet light)

Code : H10958 469€^{Incl. VAT}



Compact interface in a metallic box
512 DMX channels - Unlimited number of projectors
Access to 3D and DMX modes simultaneously
Thermal protection
USB powered - USB Cable supplied
Windows and MacOS compatible
Standalone rendering of a 512-channel scene

With a computer

- Operating System: Win/Mac
- Communication: USB
- Number of DMX channels: 1024
- Number of ArtNet channels: 1536

Stand-alone mode

- Number of DMX channels: 1024
- Number of scenes (dynamic): 16
- Number of zones: 4
- Triggers
 - 16 Flash buttons
 - Infrared remote control
 - 8 external contacts
 - Date and time



Lightshow Creator

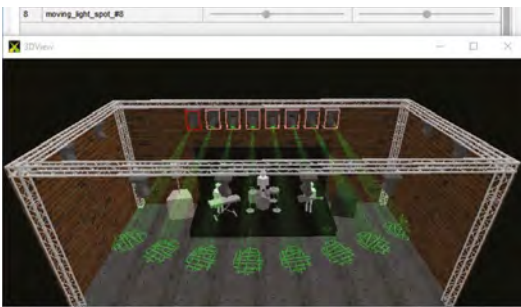

3DView – new 3D engine



Generator – individual pan & tilt offsets & zoom

1 - Lightshow Creator

Declare the fixtures and the groups of fixtures, and select the option « Lightshow Creator » in the main menu. The result is one tab per group of fixtures, with several buttons & pages for all channels, and master faders for dimmer and speed.

2 - 3DView – new 3D engine

3DView is using the application programming interface OpenGL version 3.2+, and it is now able to fully use the GPU of the video cards.

3 - Multi pan/tilt management (from Steps/Generator to 3DView)

Declare the number of the head in the window « Edit fixture ». Manage the pan/tilt channels like with 'single pan/tilt' fixtures.

4 - Live – slider «shift»

For Generator scenes, adjust the shift of a channel for all fixtures, like we do in the tab Generator with the fader « shift ».

5 - Generator – individual pan&tilt

offsets&zoom

Adjust the position & size of the curve of each fixture, in the window « Generator fixtures settings ».

6 - Generator – fan pan / tilt

Fan the pan or/and tilt of the fixtures, with only two sliders in the window « Generator fixtures settings ».

7 - Live – BPM and Beat

Clear representation and improvements of the functions BPM and Beat.

8 - Live – Virtual DJ

Switch on/off Buttons in Live with VDJ PADS. Get the VDJ music Beats in Live.



	D512S	D1024	SWEET RACK1024	NET512
WITH COMPUTER				
operating system	Win/Mac	Win/Mac	Win/Mac	Win/Mac
communication	USB	USB	USB	USB
Dmx channels	512	2 x512	2 x 512	512
Channels Artnet (via computer)	1024	1536	1536	1024
Fmx protection ESD	ESD + GROUND LOOP	ESD + OPTICAL ISOLATIONS	ESD + DOUBLE OPTICAL ISOLATIONS	ESD + OPTICAL ISOLATIONS
power	USB POWERED	USB POWERED	USB POWERED	9V ADAPTOR (SUPPLIED)
STAND-ALONE MODE				
nb dmx channels	512	512	1024	512
nb (dynamic) scenes	1	1	16	9
nb zones	1	4	4	4
calendar			✓	✓
Software update	Free	Free	Free	Free
infrared remote control			YES (INCLUDED)	

BT-NODE



BT-NODE24

(5pin XLR) - Artnet node: 2x Artnet / 4x DMX in+ou

Code : B05015

799€incl. VAT



GIGABIT Ethernet I/O with internal switch
(link without latency)
ARTNET 4.0 Protocol, sACN
4x I/O DMX fully isolated: configurable as you wish!
MIDI I/O: MIDI control via Ethernet!
Configuration via the WEB interface
RDM compatible
NFC for use with smartphones
Dual redundant power supplies :
230Vac : TRUE-1 cascade sequence
PoE class 2: Power over Ethernet
Allowing to fix 2 units in 1U 19"



BT-NODE24

(3pin XLR) - Artnet node: 2x Artnet / 4x DMX in+ou

Code : B05014

799€incl. VAT



GIGABIT Ethernet I/O with internal switch
(link without latency)
ARTNET 4.0 Protocol, sACN
4x I/O DMX fully isolated: configurable as you wish!
MIDI I/O: MIDI control via Ethernet!
Configuration via the WEB interface
RDM compatible
NFC for use with smartphones
Dual redundant power supplies :
230Vac : TRUE-1 cascade sequence
PoE class 2: Power over Ethernet
Allowing to fix 2 units in 1U 19"



BT-NODE24

Switch to speed of light

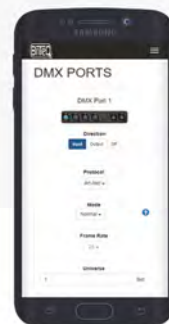
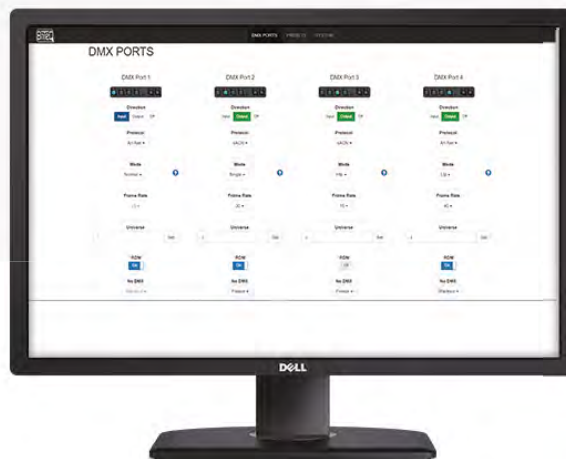

Responsive interface

BT-NODE



BT-NODE28

[3pin XLR] - Artnet node: 2x Artnet / 8x DMX in+ou

Code : B04638

569€^{Incl. VAT}



The perfect all-in-one ArtNet NODE solution with 8 highly configurable XLR 3pin DMX ports.

The 8 DMX ports can all be configured as in or outputs:

Configured as input: normal or backup mode

Configured as output: single, LTP, HTP, RDM or zero mode

You can store all your personal settings and routing options to the different user memories.

Multiple pre-defined routing options available:

4 DMX inputs with 4 local clone outputs DMX and ArtNet output

8 DMX outputs from ArtNet input, with Backup line possibilities

Different merger combinations in both directions:

Combine DMX in + ArNet universe

to Artnet or a physical DMX output (LTP or HTP)

Combine 2 DMX inputs to ArtNet (LTP or HTP)

Multiple mode DMX splitter modes:

One 1 to 7 splitter: 1 DMX input to 7 isolated DMX outputs

Two individual 2 to 3 splitters: each with 1 DMX input to 3 isolated DMX outputs

100% electrical isolation between all in/outputs: problems on 1 port will not influence the other ports.

Easy setup with OLED LCD display

Frame rate of each port can be adapted from 10ms to 40ms to increase compatibility while connecting "slow" DMX-devices to "fast" DMX-controllers.

Fully RDM compatible!



BT-NODE28

[5pin XLR] - Artnet node: 2x Artnet / 8x DMX in+ou

Code : B04642

569€^{Incl. VAT}



The perfect all-in-one ArtNet NODE solution with 8 highly configurable DMX ports.

The 8 DMX ports can all be configured as in or outputs:

Configured as input: normal or backup mode

Configured as output: single, LTP, HTP, RDM or zero mode

Multiple pre-defined routing options (modes) available:

4 DMX inputs with 4 local clone outputs DMX and ArtNet output

8 DMX outputs from ArtNet input, with "Backup line" possibilities

Different merger combinations in both directions:

Combine DMX in + ArNet universe to Artnet or a physical DMX output (LTP or HTP)

Combine 2 DMX inputs to ArtNet (LTP or HTP)

Multiple mode DMX splitter modes:

One 1 to 7 splitter: 1 DMX input to 7 isolated DMX outputs

Two individual 1 to 3 splitters: each with 1 DMX input to 3 isolated DMX outputs

On top of the pre-defined modes you can also store all your personal settings and routing options to the different user memories.

100% electrical isolation between all in/outputs: problems on 1 port will not influence the other ports.

Easy setup with OLED display

Frame rate of each port can be adapted from 10ms to 40ms to increase compatibility while connecting "slow" DMX-devices to "fast" DMX-controllers.

RDM compatible!

All DMX ports are equipped with 5pin XLR-connectors (3pin XLR-version available)

Two 10/100Mbps Ethernet ports (Neutrik RJ45 Ethercon connectors)

To increase reliability the built-in Ethernet switch has an automatic bypass function to make sure that the network stays fully operational in case of hardware failure.

BT-NODE24

- Web interface accessible with smartphones via NFC
- 2 Gigabit ports without latency
- PoE
- MIDI I/O



DMX CONTROLLERS



EZ-CON 6

6 channels DMX controller

Code : B05024 79€^{Incl. VAT}



The controller sends out 6 DMX channels.
There is NO external power adapter
It's compact size light weight makes it an easy to build in or transport controller.
Power Input: AC 110-240V, 50/60Hz
DMX output: 3pin XLR, 6ch.
Size: 180 x 135 x 55 mm
Weight: 0.9 kg



EZ-CON 24W

24 channels DMX controller with battery and wireless DMX

Code : B05023 169€^{Incl. VAT}



24 DMX channels over 8 faders and 3 pages
Over 10 hours of autonomy with a full charged battery.
Wireless DMX by means of a W-DMX G4 module from Wireless Solutions Sweden .
Wireless and wired DMX output can work simultaneously.
No external power adapters thanks to the built in power supply
Power Input: AC 110-240V, 50/60Hz
DMX output: 3pin XLR, 24ch
DMX wireless: 2.4GHz
Size: 231 x 158 x 59 mm
Weight: 1.41 kg



EZ-CON 72

72 channels DMX controller with 6 chases of 40 steps

Code : B05025 109€^{Incl. VAT}



72 DMX channels over 8 faders and 9 pages.
6 chases of 40 steps (scenes) each can be programmed.
Adjustable speed for the chases.
No external power adapters thanks to the built in power supply
Power Input: AC 110-240V, 50/60Hz
DMX output: 3pin XLR female
Size: 232 x 135 x 55 mm
Weight: 1.12 kg



MEMORY-24

24-channel DMX console for power blocks

Code : H9067 249€^{Incl. VAT}



Organ playing with 2 courses of 12 circuits or 1 course of 24 circuits
4,600 memories and 48 programmable sequences
Crossfade
Adjustable speed and rise time of sequences
Sound mode
Backup memories internally
Possibility of mixing several sequences
Sound mode
Manual triggering by Tap synchro
Triggering scenes and sequences in MIDI
DMX 512 output on 3-pin XLR plug
External power supply (DC 9 V - 12 V, 500 mA)
Dimensions: 483 x 265 x 90mm
Weight: 4.6 kg



PILOT-192PRO

192-channel DMX controller with joystick

Code : H9073 189€^{Incl. VAT}



192 channels (12 projectors of 16 channels)
30 banks of 8 programs each
12 chases (240 steps per chase)
Pan/Tilt
Fade Time
MIDI control of memories and blackout
Assignable joystick for Pan/Tilt movements
Connection for foot control and smoke machine
Sound mode
Dimensions: 483 x 82 x 135 mm
Weight: 2.2 kg



SCM-1 SCENEMASTER

16 DMX channels with MIDI output

Code : B04624 169€^{Incl. VAT}



64 channels (4 projectors of 16 channels)
16 scenes of 16 channels
MIDI control of faders and flashes
Midi In controls scenes with compatible software
16 buttons for flashes or scenes
Dimensions: 483 x 85 x 133 mm
Weight: 2.5 kg



MANU-6X

DMX 6 channels + master controller

Code : H9064 69€^{Incl. VAT}



6-channel DMX console
6 faders + Master
Operates on 9 V battery
Supplied AC adapter
Ideal for the control of architectural colour changers
DMX output: 3-pin XLR
Dimensions: 173 x 153 x 55 mm
Weight: 0.8 kg



CONTROLLER CASE 3U

Compact flight case for all kinds of small 19" controllers

Code : B03224 89€^{Incl. VAT}



Compact flight case for controllers 19" up to 3U
Accessory compartment
Rubber feet

LED DMX CONTROLLERS



LEDCON-XL

Preprogrammed controller

Code : B04661 179€^{Incl. VAT}



Controller for LED projectors
8 groups of spotlights with patchable DMX mode
Activate colors, fade and Pre-programmed chases.
8 additional cursors for manual control of other devices (smoke machine, etc.)
4- or 8-channel modulators with speed control or sound mode
Choice of RGB, white RGB, amber white RGB modes, etc.
UV button for 6-in-1 LED projectors that include a UV LED.
Separate control for strobe and dimmer.
Instant access to 9 preprogrammed colour chasers
Static or audio chaser mode 32-colour spectral blend.
Dimensions: 483 x 75 x 133 mm
Weight: 2.2 kg



PILOT-8

Programmable 8x8 channels controller

Code : H10126 199€^{Incl. VAT}



64 patchable channels (8 projectors with 8 channels each)
8 colours recorded and 24 free
8 pre-programmed colours and 24 free
Assignable patch for RGBWA and dimmer functions
2 assignable free channels
Strobe function
Adjustable sequence speed
Connectors:
- DMX output on XLR
- RJ45 for DMX control of the Contest Architecture range using the PILOT
- Jack for external controller Easy-2 for launching programs, choice of colours and Blackout
- USB for the night light supplied
Dimensions: 400 x 200 x 68 mm
Weight: 2.3 kg



PARCONTROL34

RGB and RGBW compatible DMX controller

Code : H9913 89€^{Incl. VAT}



Control of colour, prog, strobe.
Direct access to 12 colours and 3 shades of whites
RGBW colour graduation
Audio mode
Strobe speed
2 control modes
Mode 1: R, G, B, Dim/Strobe, White
Mode 2: R, G, B, White
Power supply: DC 9-12V 300mA
Dimensions: 270 x 170 x 60 mm
Weight: 1.1 Kg



LEDCON-02 Mk2

Small pre-programmed LED controller

Code : B04660 91.90€^{Incl. VAT}



Control of colour, prog, strobe.
Direct access to 9 colours
Faders for chasers, speed and Dimmer
Audio mode
Fixed patch R,G,B, Dimmer/Strobe
Works in 4 or 8 channel mode
Power supply: DC 9-12V 300mA
Dimensions: 210 x 140 x 46 mm
Weight: 1 Kg



PARCONTROL

DMX controller for RGB projector

Code : H9406 69€^{Incl. VAT}



Control of colour, prog, strobe.
Direct access to 9 colours
RGB colour graduation
Audio mode
Strobe speed
Fixed patch R, G, B, Dimmer/Strobe.
Power supply: DC 9-12V 300mA
Dimensions: 220 x 140 x 36 mm
Weight: 1 Kg



PARPILOT

DMX control box for PAR LEDs CONTEST and LED4STAGE

Code : H9658 25€^{Incl. VAT}



Control of colour, prog, strobe.
2 control modes: Fixed colour and running light
Fixed patch R,G,B, Dimmer/Strobe
Works in 4 or 16 DMX channels
10 pre-memorized internal programs
Musical Mode, Tap Tempo and Colour Variation
Quick access to 8 fixed colours
Management of scroll speed and intensity
Strobe effect
Net or progressive colour chaining
Blackout
Power supply: DC 12 V 100 mA (supplied)
Dimensions: 70 x 110 x 33 mm
Weight: 0.31 kg

DMX RECORDER



Recorded shows can easily be saved on a USB memory stick.

2 modes:

- **[User mode]:** the [DMX RECORDER] can only play recorded chases/shows. Other functions are disabled
- **[System mode]:** full control over all the functions of the [DMX RECORDER]

Recorded shows/chases can run at a fixed speed or via audio control. (external audio signal or build in microphone)

Blackout function to cut the DMX output.

2x8 digit display for easy navigation in the menu.

NEW

DMX RECORDER
512ch DMX recorder

Code : B05020 289€^{Incl. VAT}

NEW

DMX RECORDER REMOTE
Remote controller for DMX Recorder

Code : B05021 99€^{Incl. VAT}

Wired remote control for the JB Systems® [DMX RECORDER]. Ideal, easy to use, remote control for pubs and bars. Easy cleaning glass surface. Three control buttons for simplified control of the recorded chases(s):

- [PLAY]
- [STOP]
- [BLACKOUT]

Eight chase buttons for quick selection of the desired show. Wired remote control for the JB Systems® [DMX RECORDER].

DMX SPLITTERS



DMS-26

The perfect all-in-one solution for securing your DMX installations: MERGER + SPLITTER + BOOSTER.

Code : B04625 209€^{Incl. VAT}



SPLITTER:
100% electrical insulation
2 inputs and 6 DMX outputs
BOOSTER:
signal reconstruction
MERGER:
Mixer:
HTP: Priority to the highest value
Backup: if signal A is faulty then relay on signal B
Priority channel address per input.
DMX speed 23 ms to 45 ms.
Signal loss setting:
Null , Hold , Clear
4-character LED display.
Dimensions: 482 x150 x 44 mm
Weight: 2.9 kg



DS 12

PRO splitter DMX+IEC 1in/2out

Code : B04631 109€^{Incl. VAT}



SPLITTER:
100% electrical insulation
1 input and 2 DMX outputs
BOOSTER: boost the signal
Bidirectional RDM compatible
Inputs:
DMX 3 and 5 XLR
IEC 10A
Outputs:
2 DMX XLR3
2 IEC 10A
Dimensions: 130 x132 x 56 mm
Weight: 0.95 kg



MINI DMX-SPLITTER

Mini DMX splitter 1in/2out

Code : B04630 39€^{Incl. VAT}



SPLITTER:
1 input and 2 DMX outputs
BOOSTER: boost the signal
Inputs:
DMX XLR 3
Outputs:
2 DMX XLR3
Dimensions: 102 x 72 x 40 mm
Weight: 0.24 kg

DMS-26

The perfect all-in-one solution to secure your installations.



The perfect all-in-one solution to secure your DMX-installations: MERGER + SPLITTER + BOOSTER

100% electrical isolation between all in/outputs!
2 DMX-inputs + 6 DMX-outputs, each equipped with 3pin and 5pin XLR-connectors.

The booster function analyses the incoming DMX-signal and builds it back up from scratch to make it perfect for further use.

The merger function combines 2 DMX-signals in different ways:

HTP: the highest value of 2 identical channels from 2 DMX-signals will have priority.

Backup: when the DMX-signal on input A fails, the DMX-signal in input B takes over immediately.

Merger: DMX-signals from 2 different controllers can be combined and send over 1 cable, you can choose the start

address of the second controller.

The splitter function distributes the DMX-signal(s) from the input(s) over 6 identical outputs that are 100% isolated from each other: problems that occur on 1 output will not influence the other outputs!

The timing of the DMX-outputs can be adapted from 23ms to 45ms, increasing compatibility while connecting "slow» DMX-devices to "fast» DMX-controllers.

Output behavior can be selected when suddenly both DMX-inputs fail:

Null: no DMX signal on the outputs

Hold: keep the last DMX values on the outputs.

Clear: set the DMX values on all outputs to zero.

Easy setup via 4digit LED display

WIRELESS DMX

NEW



AirBoxIP

IP65 wireless DMX transceiver IP65

Code : H11032

149€^{Incl. VAT}



Wireless airDMX transmitter and receiver via WiFi at 7 frequencies
Average range 100 m in the open area *.
Frequency band 2,400-2,483GHz ISM
512-channel DMX
Channel selection key with tricolor indicator light
Choice of 7 different channels to make groups of projectors
Power supply: AC 100/240 V - 50/60 Hz
Supplied with mounting brackets, IP/XLR DMX IN/OUT cables and IP/AC IN cable.



airBOX-ER1

Wireless DMX transmitter and receiver box of 512 DMX channels and 7 WiFi frequencies

Code : H9966

119€^{Incl. VAT}



Wireless airDMX transmitter and receiver via WiFi at 7 frequencies
- ISM 2,400-2,483GHz frequency band
Channel selection button with tricolor LED
Choice of 7 different channels to make groups of projectors
Power supply:
- AC 100/240 V - 50/60 Hz
Input and output power
DMX input and output on XLR3
Maximum transmission power:
20 dBm/100 mW
Removable bracket for hanging on structures and wall attachment
Dimensions: 165 x 120 x 53 mm
Net weight: 0.5 kg



M-DMX TRANSCEIVER

Wireless DMX! Compatible with WTR-DMX DONGLE.

Code : B04646

99€^{Incl. VAT}



Transceiver can operate in transmitter or receiver mode
- 2.4 GHz frequency band
Compatible with the "Wireless Solution" W-DMX™ Protocol
Works perfectly with Briteq WR-DMXG4 [4632] in WT-DMXG4 [4633]
5V DC power supply via micro USB or adapter included
DMX input and output on XLR3
Dimensions: 103 x 76 x 36 mm
Net weight: 0.250 kg



WTR-DMX DONGLE

The perfect solution for anyone looking for an extremely reliable wireless DMX!

Code : B04645

59€^{Incl. VAT}



Transceiver can operate in transmitter or receiver mode
- 2.4 GHz frequency band
Compatible with the "Wireless Solution" W-DMX™ Protocol
Works perfectly with Briteq WR-DMXG4 [4632] in WT-DMXG4 [4633]
5V DC power supply via USB port
DMX connection via USB port
Dimensions: 71 x 42 x 11 mm
Net weight: 0.02 kg



Unrestrained control even outdoors (IP65)

Receive and transmit 512 DMX channels via Wi-Fi on 7 frequencies.

The AirBoxIP allow you to transmit or receive the airDMX signal. As soon as it detects an incoming DMX wired signal the AirBoxIP automatically transmits it as a Wi-Fi DMX signal.

The removable attachment system allows you to easily install the AirBoxIP on a wall or on any suitable structure.

The power socket can be used to link the AirBoxIP to other DMX projectors.

UPDATERS

NEW



FIRMWARE UPDATER 2+

Code : B05019 79€Incl. VAT



This unit can be used to easily upgrade the firmware of compatible DMX-effects & projectors.
 One or more DMX-effects can be upgraded simultaneously through their DMX-in/out connections.
 RDM functionality: check several functions + change DMX-address / DMX-channel mode.
 DMX-controller:
 Mini-USB input to recharge the internal battery.
 Output: XLR 3pin
 USB/micro SD-card adapter + mini-USB cable + micro SD-card included.



FIRMWARE UPDATER

This device allows you to do firmware updates on DMX projectors and light effects.

Code : B04319 42.90€Incl. VAT



Firmware update box for compatible devices.
 Works with the software that allows you to load the program via the USB port.
 Possible to update multiple devices in one time.
 Check the compatibility of your device.



FIRMWARE UPDATER 3

Firmware update cable

Code : B04389 29€Incl. VAT



Firmware update cable for compatible devices.
 Works with the software that allows you to load the program via the USB port.
 Possible to update multiple devices in one time.
 Check the compatibility of your device.

SPECIFIC REMOTES



CA-8

Remote compatible with most lighting effects

Code : B04192 16.90€Incl. VAT



Colour/gobo control of programs and of Blackout.
 Connectivity: 6.35 stereo jack
 Cable length: 11 m



BT-STR4

4-channel controller for strobes.

Code : B04712 59€Incl. VAT



Strobe controller
 Analog outputs and DMX (2-channel)
 Manual or automatic operation 10 different programs
 Single flash, Full on / Blinder, Blackout
 Adjustable speed
 Dimmer (only in DMX)
 Audio mode
 Compatible with analog strobes using 12V DC pulses such as: MEGA STROBE 1500, ...
 Compatible with DMX strobes using 2 channels such as: MEGA STROBE 1500 DMX, BT-STROBE 3000, ...



DIMMER PACKS



BT-626/FRA
6-channel professional Dimmer/Switch pack for rack mounting 19".

Code : B04634 469€^{incl. VAT}





BT-626/GER
6-channel professional Dimmer/Switch pack for rack mounting 19".

Code : B04635 469€^{incl. VAT}



Power rating: 16 A (3500 W) per channel / 96 A max. resistive/inductive
Protection of each channel by circuit breaker
LEDs indicating charge presence on each channel
Independent addressing of each channel
6 linear potentiometers for manual dimming
Preheat control of lamps from 0 to 6%
LED display to monitor all functions, including internal temperature
Power supply: single-phase or three-phase on terminal blocks (230 V - 50 Hz)
6 16A French plug outputs on the back
DMX XLR 3 and RJ11 input and output
0/10V input on DB9
Dimensions: 482 x 312 x 90
Weight: 8 kg

Same as BT-626/FRA but with outputs on 6 standard German plugs.



DIM-1X10
1-channel 1x10A DMX block with PC output fader

Code : H9061 109€^{incl. VAT}





DIM-4X5
4-channel 4 x 5A compact DMX block with faders

Code : H9057 199€^{incl. VAT}



Power rating: 10 A (2200W) resistive/inductive
Linear potentiometers for manual dimming
Cable length of the remote fader: 1.8 m
LED display with drop-down menu
DMX input/output on 3-pin XLR plugs
Output on French plug
Power supply: AC 230 V, 50 / 60 Hz
Dimensions: 150 x 125 x 82 mm
Weight: 1.5 kg

Power rating: 5 A (1100 W) per channel / 16 A max. resistive/inductive
16 internal chase programs with variable speed
Individual fader per channel, with speed adjustment
4 DMX channels with independent assignment in DMX 512
Modes: Master/slave, program, DMX, sound via build-in microphone.
Switch/dimmer pack
Control of 4 DMX channels via faders
Outputs on 4 French mains plugs
Power supply: AC 120 V / 230 V - 50 / 60 Hz, 16 A maximum
Dimensions: 250 x 208 x 68 mm
Weight: 2.5 kg

DIMMER PACKS



DSP-4 Mk2 /F
Multifunctional dimmer/switch pack with 4 sockets (French Schuko).

Code : B04643 219€^{Incl. VAT}





DSP-4 Mk2 /G
Multifunctional dimmer/switch pack with 4 sockets (German Schuko).

Code : B04644 219€^{Incl. VAT}



DSP-4 MK2

Suitable for low power LED loads. Minimum load from 10 W / channel

Power rating: 8 A (1850 W) per channel / 15 A max. resistive/inductive
Protection of each channel by fuse
Independent addressing of each channel
LED display with drop-down menu
Power supply: 240V - 50Hz single phase
4 16A French plug outputs on the front
DMX XLR 3 input and output
Dimensions: 482 x 100 x 88
Weight: 2.9 kg

identical to the DSP-4 MK2 but with outputs on 4 standard German plugs.



DSP-4 compatible with «TRIAC» compatible «LED» projectors



ELECTRICAL DISTRIBUTION



PD-63SH/FRA-BEL

Distributor 63A Tetra / 12x16A Mono + 2x 16PIN + 2x19PIN + 1 CEE 63A output.

Code : B04647

1039€^{Incl. VAT}



1 x 63A 4-pole circuit breaker (3P+N) for protection of all outputs, including 63A output
 1 x 30 mA 63A differential circuit breaker for the protection of persons
 12 x bipolar circuit breakers for 12 16A standard French outlets (4 outlets per phase)
 V-meters + A-meters per phase
 1.5 m mains input cable with CEE 63A plug
 1 x CEE 63A output connector
 2 x 16-pin harting type connector
 2 x 19 pin socapex type connector
 Dimensions: 482 x 266 x 326 mm
 Rackable 19" height 6U
 Power supply: 400V - 50 Hz (3P+N+E)
 Weight: 11.74 kg



PD-63SH/GERMAN

Distributor 63A Tetra / 12x16A Mono + 2x 16PIN + 2x19PIN + 1 CEE 63A output.

Code : B04648

1039€^{Incl. VAT}



1 x 63A 4-pole circuit breaker (3P+N) for protection of all outputs, including 63A output
 1 x 30 mA 63A differential circuit breaker for the protection of persons
 12 x bipolar circuit breakers for 12 16A standard German outlets (4 outlets per phase)
 V-meters + A-meters per phase
 1.5 m mains input cable with CEE 63A plug
 1 x CEE 63A output connector
 2 x 16-pin harting type connector
 2 x 19 pin socapex type connector
 Dimensions: 482 x 266 x 326 mm
 Rackable 19" height 6U
 Power supply: 400V - 50 Hz (3P+N+E)
 Weight: 11.74 kg



PD-63A Mk2/FRA-BEL

Distributor 63A Tetra / 2 x outputs CEE 32A + 3 x 16A Mono.

Code : B04639

659€^{Incl. VAT}



1 x 30 mA 63A differential circuit breaker for the protection of persons
 2 x 32A 4-pole circuit breakers (3P+N) for the protection of two P17 32A outputs
 3 x bipolar circuit breakers for 3 16A standard French outlets (1 outlet per phase)
 V-meters + A-meters per phase
 1.5 m mains input cable with CEE 63A plug
 2 x CEE 32A output connectors
 Dimensions: 482 x 274 x 152 mm
 Rackable 19" height 3U
 Power supply: 400V - 50 Hz (3P+N+E)
 Weight: 11.74 kg



PD-63A Mk2/GER-NL

Distributor 63A Tetra / 2 x outputs CEE 32A + 3 x 16A Mono.

Code : B04640

659€^{Incl. VAT}



1 x 30 mA 63A differential circuit breaker for the protection of persons
 2 x 32A 4-pole circuit breakers (3P+N) for the protection of two P17 32A outputs
 3 x bipolar circuit breakers for 3 16A standard German outlets (1 outlet per phase)
 V-meters + A-meters per phase
 1.5 m mains input cable with CEE 63A plug
 2 x CEE 32A output connectors
 Dimensions: 482 x 274 x 152 mm
 Rackable 19" height 3U
 Power supply: 400V - 50 Hz (3P+N+E)
 Weight: 11.74 kg

ELECTRICAL DISTRIBUTION



PD-32SH/FRA-BEL

Distributor 32A Tetra / 6 x 16A Mono + 1 x 16PIN + 1x19PIN + 1 x CEE 32A output.

Code : B04636

559€^{incl. VAT}



1 x 30 mA 32A differential circuit breaker for the protection of people
 1 x 32A 4-pole circuit breaker (3P+N) for protection of all outputs, including the 32A output
 6 x bipolar circuit breakers for 6 16A standard French outlets (2 outlets per phase)
 V-meters + A-meters per phase
 1.5 m mains input cable with CEE 32A plug
 1 x CEE 32A output connector
 2 x 16-pin harting type connector
 2 x 19 pin socapex type connector
 Dimensions: 482 x 258 x 152 mm
 Rackable 19" height 3U
 Power supply: 400V - 50 Hz (3P+N+E)
 Weight: 8.78 kg



PD-32SH/GERMAN

Distributor 32A Tetra / 6 x 16A Mono + 1 x 16PIN + 1x19PIN + 1 x CEE 32A output.

Code : B04637

559€^{incl. VAT}



1 x 30 mA 32A differential circuit breaker for the protection of people
 1 x 32A 4-pole circuit breaker (3P+N) for protection of all outputs, including the 32A output
 6 x bipolar circuit breakers for 6 16A standard German outlets (2 outlets per phase)
 V-meters + A-meters per phase
 1.5 m mains input cable with CEE 32A plug
 1 x CEE 32A output connector
 2 x 16-pin harting type connector
 2 x 19 pin socapex type connector
 Dimensions: 482 x 258 x 152 mm
 Rackable 19" height 3U
 Power supply: 400V - 50 Hz (3P+N+E)
 Weight: 8.78 kg



BREAK-3X16

3x16A power supply block on 6 outlets with vu-meter

Code : H9059

299€^{incl. VAT}



3 x bipolar circuit breakers for 6 16A standard French outlets (2 outlet per phase)
 V-meters + A-meters per phase
 1 x CEE 16A input connector
 1 x 16A socket in front on phase 1
 Dimensions: 482 x 260 x 152 mm
 Rackable 19" height 2U
 Power supply: 400V - 50 Hz (3P+N+E)
 Weight: 3.8 kg



ELECTRICAL DISTRIBUTION



DIST3x2F

TRI 1xCEE16A distributor - 3x2 French outlets

Code : H10838

69€^{Incl. VAT}



Rackable distributor 19" height 1U
Power input cable in 5G1.5mm² with a length of 2 m + Tetra CEE 16A plug
6 16A standard French sockets on the front (2 outlets per phase)
Weight: 1.1 Kg



DIST3x2E

TRI 1xCEE16A distributor - 3x2 European outlets

Code : H10839

69€^{Incl. VAT}



Rackable distributor 19" height 1U
Power input cable in 5G1.5mm² with a length of 2 m + Tetra CEE 16A plug
6 16A standard German sockets on the front (2 outlets per phase)
Weight: 1.1 Kg



DIST-CUBE

Tri 1xCEE16A distributor / 3 x European outlets

Code : H10868

35€^{Incl. VAT}



Cube format distributor
2 M10inserts
Tetra CEE 16A input plug
3 16A standard German plugs (1 outlet per phase)
Dimensions: 160 x 136 x 102 mm
Weight: 0.86 Kg



PC-8 Mk2 FRA/BEL

8-channel dispatch with bipolar switches

Code : B02049

99€^{Incl. VAT}



Outputs on 8 IP54 outlets
Standard French plugs
8 bipolar switches
6.3 amp fuse for each channel
the total charge cannot exceed 15 amps (3300 W)
Rackable 19 inches / 2U
Dimensions: 483 x 80 x 97 mm
Power supply: 230V - 50 Hz
Weight: 2 kg



PC-8 Mk2 GER

8-channel dispatch with bipolar switches

Code : B02059

99€^{Incl. VAT}



Outputs on 8 IP54 outlets
Standard German plugs
8 bipolar switches
6.3 amp fuse for each channel
the total charge cannot exceed 15 amps (3300 W)
Rackable 19 inches / 2U
Dimensions: 483 x 80 x 97 mm
Power supply: 230V - 50 Hz
Weight: 2 kg



RG2x8

1U double-sided rackable strip, 2x8 European plugs

Code : H10837

69€^{Incl. VAT}



1U rackable 19" strip with:
8 sockets in front / 16A protection
8 sockets at the rear / 16A protection
2 front bipolar switches to control front outlets and rear outlets
Standard German plugs with child protection
3G1.5mm² cable - length 2m
Dimensions: 483 x 46 x 90 mm
Power supply: 230V - 50 Hz
Weight: 1.33 kg



RG8USB

1U rackable strip, 8 European plugs + 2xUSB

Code : H10840

39€^{Incl. VAT}



1U rackable 19" strip with:
8 sockets on the back
2 USB ports (1A) on the front
1 bipolar switch on the front panel to control the outlets
Standard German plugs with child protection
3G1.5mm² cable - length 2m
Dimensions: 483 x 46 x 90 mm
Power supply: 230V - 50 Hz
Weight: 1 kg

LIFTING CONTROL



RICO-V8

8-channel chain lift motor controllers with separate UP / DOWN buttons and master / slave function.

Code : B07000 1299€^{Incl. VAT}



Standalone controller for chain lift motors. Control up to 8 motors independently. Compatible with the RICO-V4 model. Multiple units can be connected as master/slave. Simultaneous control of the hoists using the UP/DOWN buttons on the master controller. Emergency stop. "Slave" LED indicator light. Manual phase inversion switch for each output. Choice of different outputs: 4 16 A outputs, 4 individual CEE poles. 2x 16-pin connectors, Harting® type. 2x 19-pin connectors, Socapex® type. 1x PowerCON 16 A power outlet. XLR input for the remote control [RICO-REMOTE] (optional). Phase indicators available. A 4-pole 32A circuit breaker protects ALL outlets, including the 32A output to the next unit in the chain. In case of emergency, all the phases AND the neutral are disconnected. 2x C16 bipolar automatic circuit breakers (16 A - 1P+N) for the protection of circuits + auxiliary output. AC input cable (3 x 32 A, 5 wires), equipped with CEE 32 A input socket (3P+N+T). Output connector bypass (3 x 32 A, 5 wires) of EEC type (3P+N+T) (19 inches)/4 U rugged metallic box. Designed and manufactured in Europe. Dimensions: 482 x 184 x 430 mm. Power supply: 400V - 50 Hz (3P+N+E). Weight: 13.5 kg.



RICO-V4

4-channel chain lift motor controllers with separate UP / DOWN buttons and master / slave function.

Code : B04649 899€^{Incl. VAT}



Standalone controller for chain lift motors. Control up to 4 motors independently. Multiple units can be connected as master/slave. Simultaneous control of the hoists using the UP/DOWN buttons on the master controller. Emergency stop. "Slave" LED indicator light. Manual phase inversion switch for each output. Choice of different outputs: 4 16 A outputs, 4 individual CEE poles. 1x 16-pin connectors, Harting® type. 1x 19-pin connectors, Socapex® type. 1x PowerCON 16 A power outlet. XLR input for the remote control [RICO-REMOTE] (optional). Phase indicators available. A 4-pole 32A circuit breaker protects ALL outlets, including the 32A output to the next unit in the chain. In case of emergency, all the phases AND the neutral are disconnected. 2x C16 bipolar automatic circuit breakers (16 A - 1P+N) for the protection of circuits + auxiliary output. AC input cable (3 x 32 A, 5 wires), equipped with CEE 32 A input socket (3P+N+T). Output connector bypass (3 x 32 A, 5 wires) of EEC type (3P+N+T) (19 inches)/4 U rugged metallic box. Designed and manufactured in Europe. Dimensions: 482 x 184 x 430 mm. Power supply: 400V - 50 Hz (3P+N+E). Weight: 13.5 kg.



RICO-REMOTE

Remote control for RICO-V4 and RICO-V8

Code : B04650 139€^{Incl. VAT}



Equipped with:
2 UP / DOWN buttons
1 backlit emergency stop button
1 6.5m cable (XLR 5pin male / female)

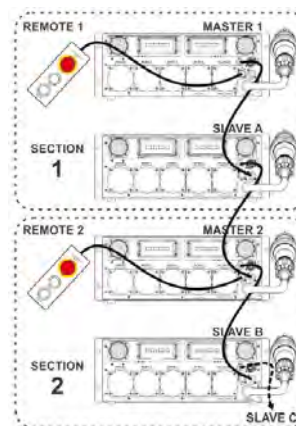



EFFECT MACHINES

LOW FOG MACHINES

GEYSER MACHINES

SNOW MACHINES

FAZER MACHINES

SMOKE MACHINES

BUBBLES MACHINES

FIREMAN SMOKE MACHINE

FAN

PERFUMES AND LIQUIDS

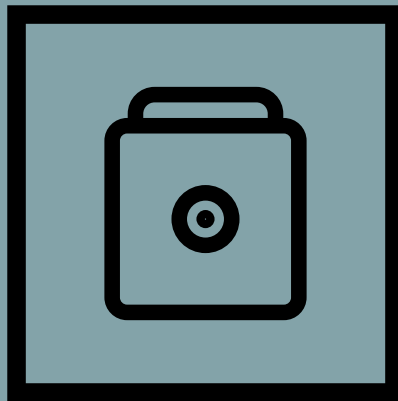

LOW FOG MACHINES



BT-H2FOG

Low Fog machine without restriction

1500W Low Fog machine in flightcase producing heavy smoke thanks to ultrasonic technology that is much less restrictive than dry ice and just as efficient.

Easy to use: it only needs tap water (demineralized water is recommended) and smoke liquid.

The «Click-on» system allows quick assembly and disassembly of the diffuser.

NEW



BT-H2FOG II
Ultrasonic 1500W Low Fog machine in flight case

Code : B04899 1349€^{Incl. VAT}



The black hose is equipped with a "fast click-on" system to significantly reduce installation time!
The included metal nozzle ensures a better distribution of the low fog.
Adjustable fog output and fan speed: Via 2 DMX channels
Via the on board control panel with LCD-display and timer
Compatible wireless DMX: just plug-in an optional WTR-DMX DONGLE !
[Briteq® code: B04645]
Original Neutrik® PowerCON and 3-pin DMX connectors for input and output
Strong flight case, equipped with recessed flip handles and 4 soft rubber casters with brakes.

Recommended liquid :
BT-LOWFOG LIQUID 5L (B04854)

NEW



BT-H2FOG COMPACT
Ultrasonic 1250W Low Fog machine

Code : B04900 759€^{Incl. VAT}



Ultrasonic 1250W Low Fog machine.
The powerful ultrasonic element convert the combination of smoke fluid and distilled water into a large amount of beautiful low-lying fog.
No more hassle with expensive and hard to find CO2 dry ice ! The black hose is equipped with a "fast click-on" system to significantly reduce installation time!
Adjustable fog output and fan speed: Via 2 DMX channels
Via the on board control panel with LCD-display and timer
Stainless steel "304" water tank (instead of ordinary treated iron) to avoid rust!
Prepared for wireless DMX: just plug-in an optional WTR-DMX DONGLE !
[Briteq® code: 4645]
Original Neutrik® PowerCON and 3-pin DMX connectors for input and output

Recommended liquid :
BT-LOWFOG LIQUID 5L (B04854)



BT-H2FOG II

GEYSER MACHINES

NEW



Neutrik TRUE 1 Connector
 RGBA LEDs on board.
 Optional Wireless DMX available.
 New structure design for multiple angle rigging
 Auto-sensing frequency
 Fluid tank compartment for ease of transportation
 Huge output volume with high pigments LED colors
 Great fit for Stage purpose
 Generate fog at any orientation

M-7X

1500 Watt, incl. RGBA LED effect

Code : B04853

799€^{Incl. VAT}



Recommended liquid :
FLC-5 (B04834)



COLOR JET

Powerful vertical jet smoke machine with 6 3 W RGB LEDs

Code : B04892

209€^{Incl. VAT}



Light source: 6x3W RGB LEDs
 Heating element: 900W
 Preheating time: 4 minutes
 Tank: 2.5 litres
 HF remote with 4 programmable buttons
 DMX mode: 4 channels
 Power supply: 230V - 50Hz
 Power consumption: 950W max.
 Dimensions: 340 x 250 x 130 mm
 Net weight: 5.5 kg

Recommended liquid :
FLC-5 (B04834)

SNOW MACHINES



S-500

Professional snow machine, controlled by DMX and set up in a flight case.

Code : B04848

1459€^{Incl. VAT}



PM-1

Horizontal movement motor for ANTARI S-500 snow machine.

Code : B04849

399€^{Incl. VAT}



YETI Mk2

Snow machine with DMX control

Code : B04896

189€^{Incl. VAT}



DMX-controlled air volume and liquid flow
 Tank: 20 litres
 Max. consumption: 400 ml/min at 100%
 Effect output equipped with a 10m air hose.
 Control panel: LCD display
 Volume and Timer Mode
 Integrated DMX wireless receiver:
 DMX mode: 2 channels
 Horizontal movement motor PM-1 (120°)
 optional
 Power supply: 230V - 50Hz
 Power consumption: 890W max.
 Dimensions: 592 x 551 x 651 mm
 Net weight: 37.2 kg

Recommended liquid :
SL-5H (B04852)

Horizontal movement motor (120°)
 Compatible with S-500

Mains power input: 230 V AC, 50 Hz
 Power consumption: 1200 W
 DMX connectors: 3-pin XLR input + output
 Number of DMX channels: 1
 Fuse: T 8 A/250 V (slow-blow 6 x 30 mm)
 Tank capacity: 5l
 Dimensions: 530 x 260 x 320 mm (without suspension bracket)
 Weight: 8.70 kg

Recommended liquid :
SNOW LIQUID 5L (B04813)

HAZER & FAZER MACHINES

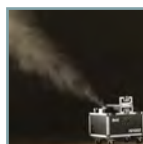

HZ-1000
Hazer machine

Code : B04861 2699€^{Incl. VAT}



The maximum haze output is HZ-500's double.
Two operational modes: Single-Compressor or Twin-Compressor mode can be selected to create needed haze volume.
Equipped with TFT color Touch Panel provides simple control interface.
Flight case with wheels gives better protections for tours.
Internal turbo fan enables haze to go higher and farther. Wind diverter can be set to 3 different angles.
Dry haze with minimum residues.
6.4-liter large reservoir allows long time operation without frequent refills.
Clear liquid level indication window.
Operating time : 40 hrs max. output

Recommended liquid :
HZL-5W (B04837) & HZL-5 (B04832)



F-7 Smaze
All-in-one solution: fog and mist modes

Code : B04844 1989€^{Incl. VAT}



Tank: 5 litres
Preheating time: 8 minutes
Output volume:
Fog mode: 650 m3 per minute
Faze mode: 170 m3 per minute
Max. consumption
Fog mode: 140 ml/min
Faze mode: 28 ml/min
Control panel: LCD screen, smoke volume and diffusion fan speed management
DMX mode: 3 channels
Integrated DMX wireless receiver:
Power supply: 230V - 50Hz
Power consumption: 1650W max.
Dimensions: 710 x 412 x 710 mm
Net weight: 52.5 Kg

Recommended liquid :
FLG-5 (B04838)



HZ-500
Hazer machine

Code : B04817 1690€^{Incl. VAT}



Tank: 2.5 litres
Output volume: 85 m3 per minute
Max. consumption. 1.1ml/min
Control panel: LCD display
Volume and Timer Mode
DMX mode: 1 channel
Noise level: lower than 70 dB from 10cm
Power supply: 230V - 50Hz
Power consumption: 480W max.
Dimensions: 490 x 351 x 338 mm
Net weight: 31.5 Kg

Recommended liquid :
HZL-5W (B04837) & HZL-5 (B04832)



F-5D
Fazer machine trustworthy and efficient.

Code : B04846 1369€^{Incl. VAT}



Heating element: 800W
Preheating time: 4 minutes
Tank: 2.8 litres
Output volume: 85 m3 per minute
Max. consumption 3ml/min at 100%
Control panel: LCD screen, smoke volume and diffusion fan speed management
DMX mode: 2 channels
Integrated DMX wireless receiver:
Power supply: 230V - 50Hz
Power consumption: 800W max.
Dimensions: 535 x 465 x 225 mm
Net weight: 22.9 Kg

Recommended liquid :
FLG-5 (B04838)



HZ-350
Hazer machine

Code : B04826 799€^{Incl. VAT}



Tank: 2.5 litres
Output volume: 57 m3 per minute
Max. consumption. 0.8 ml/min
Control panel: LCD display
Volume and Timer Mode
DMX mode: 1 channel
Wireless remote included
Power supply: 230V - 50Hz
Power consumption: 390 W max.
Dimensions: 492 x 273 x 314.5 mm
Net weight: 14.2 Kg

Recommended liquid :
HZL-5W (B04837) & HZL-5 (B04832)



HAZETEC
Smoke / Fazer machine

Code : H10487 649€^{Incl. VAT}



Heating element: 1400W (preheating), 90W (operation)
Preheating time: 46 seconds
Tank: 6 litres
Output volume: 99m3 per minute
Max. consumption 17ml/min at 100%
Control panel with smoke volume and diffusion fan speed management
2 DMX channels: Smoke volume and diffusion fan speed
Power supply: 230V - 50Hz
Power consumption: 900W max.
Dimensions: 343 x 364 x 290 mm
Net weight: 11.9 Kg

Recommended liquid :
MD6L (H10491)



FLY-HAZETEC
Flight case for HAZETEC

Code : H10510 229€^{Incl. VAT}



FAZER MACHINES



BT-FAZE 7500

Machine à brouillard 1200W - 7500cuft
DMX Prof.

Code : B04851 469€^{Incl. VAT}



Mains Input: AC 230V, 50Hz
Power consumption: 1200 Watt
DMX Channels: 2
Smoke dissipation by a powerful turbine
Fuse: T8A/250V (slow blow 6x30mm)
Output: +/- 7500 cubic ft/min (200m3)
Warm up time: 2.5 min
Tank size: 5L
Size: 490x225x330mm
Weight: 12kg

Recommended liquid :
FLG-5 (B04838)



Z-380

Hazer machine

Code : B04847 529€^{Incl. VAT}



Heating element: 1500W
Preheating time: 1.5 minutes
Tank: 1.2 litres
Output volume: 170m3/min
Max. consumption: 6 ml/min at 100%
Control panel with smoke volume and fan management
DMX mode: 1 or 2 channels
Use liquid:
Power supply: 230V - 50Hz
Power consumption: 1500W
Dimensions: 328 x 248 x 265 mm
Net weight: 8.48 kg

Recommended liquid :
FLG-5 (B04838)



Z-350

Fazer

Code : B04828 399€^{Incl. VAT}



Heating element: 700W
Preheating time: 4 minutes
Tank: 1.3 litres
Output volume: 85m3/min
Max. consumption: 3ml/min at 100%
Control panel with smoke volume and fan management
2 DMX channels: Smoke/fan
Power supply: 230V - 50Hz
Power consumption: 900W max.
Dimensions: 320 x 153 x 391 mm
Net weight: 8.8 kg

Recommended liquid :
FLG-5 (B04838)



FAZE-700

Fazer

Code : B04891 209€^{Incl. VAT}



Heating element: 700W
Preheating time: 3 minutes
Tank: 1.2 litres
Output volume: 39.65 m3/min
Adjustable fog output:
Via the integrated control panel.
Via wired remote (included).
Power supply: 230V - 50Hz
Power consumption: 700W
Dimensions: 300 x 147 x 290 mm
Net weight: 5 kg

Recommended liquid :
FOG LIQUID HI-TECH (B04812)
FOG LIQUID STD (B04811)



Z-3

ANTARI wired remote Z-350

Code : B04829 49€^{Incl. VAT}



Wired remote for Z-350
Connector: stereo jack 6.35 mm
Function: Volume, start/stop

SMOKE MACHINES



W-515D

Smoke machine 1500W

Code : B04842

649€^{Incl. VAT}



W-530D

Smoke machine 3000 W

Code : B04843

789€^{Incl. VAT}



Z-3000 II

Smoke machine 3000W + remote

Code : B04809

769€^{Incl. VAT}



Z-1500 II

Smoke machine 1500W + remote

Code : B04808

599€^{Incl. VAT}



Heating element: 1500W
Preheating time: 10 minutes
Tank: 6 litres
Output volume: 566 m3/min
Max. consumption: 10 min/litre at 100%
Wireless remote included
Control panel: LCD display
Management: Volume, Timer
DMX mode: 1 channel
Integrated DMX wireless receiver
Power supply: 230V - 50Hz
Power consumption: 1500W max.
Dimensions: 561 x 278 x 186 mm
Net weight: 14 kg

Recommended liquid :
FLG-5 (B04838)

Heating element: 3000W
Preheating time: 12 minutes
Tank: 6 litres
Output volume: 1132 m3/min
Max. consumption: 6 min/litre at 100%
Wireless remote included
Control panel: LCD display
Management: Volume, Timer
DMX mode: 1 channel
Integrated DMX wireless receiver
Power supply: 230V - 50Hz
Power consumption: 3000W max.
Dimensions: 581 x 278 x 186 mm
Net weight: 14 kg

Recommended liquid :
FLG-5 (B04838)

Heating element: 3000W
Preheating time: 12 minutes
Tank: 6 litres
Output volume: 1132 m3/min
Max. consumption: 200 ml/min at 100%
Detachable control panel:
Management: Volume, Timer, Manual
DMX mode: 1 channel
Power supply: 230V - 50Hz
Power consumption: 3000W max.
Dimensions: 581 x 278 x 186 mm
Net weight: 14 kg

Recommended liquid :
FLG-5 (B04838)

Heating element: 1500W
Preheating time: 9.5 minutes
Tank: 6 litres
Output volume: 566 m3/min
Max. consumption: 110 ml/min at 100%
Detachable control panel:
Management: Volume, Timer, Manual
DMX mode: 1 channel
Power supply: 230V - 50Hz
Power consumption: 1500W max.
Dimensions: 688 x 285 x 257 mm
Net weight: 14 kg

Recommended liquid :
FLG-5 (B04838)



Z-1200 II

Smoke machine 1200W + remote

Code : B04807

469€^{Incl. VAT}



Z-30PRO-433

Wireless control module for Z-1500II / Z-3000II

Code : B04827

179€^{Incl. VAT}



WTR-20

Wireless transmitter and receiver 433MHz

Code : B04883

79€^{Incl. VAT}



Heating element: 1200W
Preheating time: 9.5 minutes
Tank: 2.5 litres
Output volume: 510 m3/min
Max. consumption: 90 ml/min at 100%
Control panel:
Management: Volume, Timer, Manual
DMX mode: 1 channel
Power supply: 230V - 50Hz
Power consumption: 1200W max.
Dimensions: 458 x 243 x 251 mm
Net weight: 10.9 kg

Recommended liquid :
FLG-5 (B04838)

1 x W-2 transmitter
1 x W-2 receiver
frequencies: 315MHz and 433MHz

SMOKE MACHINES



FX-1200

Smoke machine - 1200W

Code : B04895 159€^{Incl. VAT}



FX-700

Smoke machine - 700 W

Code : B04818 89€^{Incl. VAT}



FC-5

Wireless remote for FX-700

Code : B04819 51.90€^{Incl. VAT}



Heating element: 1200W
Preheating time: 5 minutes
Tank: 2,5 litre
Output volume: 510 m³/minute
Wired and wireless remote included
Wireless FC-5 remote optional
Power supply: 230V - 50Hz
Power consumption: 1200W max.
Dimensions: 475 x 253 x 200 mm
Net weight: 6.55 kg

Recommended liquid :
FOG LIQUID HI-TECH (B04812)
FOG LIQUID STD (B04811)

Heating element: 700W
Preheating time: 5 minutes
Tank: 0.8 litres
Output volume: 70 m³/minute
Wired remote included
Wireless FC-5 remote optional
Power supply: 230V - 50Hz
Power consumption: 700W max.
Dimensions: 330 x 160 x 130 mm
Net weight: 3.65 kg

Recommended liquid :
FOG LIQUID HI-TECH (B04812)
FOG LIQUID STD (B04811)

Wireless remote for F-80Z, FX-700 and FX-100
The receiver's magnetic housing can be attached to the smoke machine
Range: ± 30m

BUBBLES MACHINE



FX-400

Smoke machine with Amber LEDs

Code : B04897 54.90€^{Incl. VAT}



MAGICAN

Fog in a tank

Code : B04833 11.90€^{Incl. VAT}



Power supply: 220 to 240 V AC, 50 Hz
Power consumption: 400 W
Fuse (size: 5 x 20 mm) : 250 V/5 A
Preheating time: 2 to 3 min
Tank capacity: 0.5 l
Liquid consumption: 4 ml/min
LED: 3 x 3 W (amber)
Dimensions: 237 x 118 x 163 mm
Weight: 1.8 kg

Recommended liquid :
FOG LIQUID HI-TECH (B04812)
FOG LIQUID STD (B04811)

Very original.
Fog in a tank!
For use in small rooms
Always ready for use
Non-toxic, non-irritating, does not damage ozone layer



BUBBLE-01

Bubble machine

Code : B04893 42.90€^{Incl. VAT}



This machine functions with a special ready to use liquid.
Use liquid: **BUBBLE LIQUID 5L**
Power supply: 230V - 50Hz
Power consumption: 30W max.
Dimensions: 200 x 240 x 210 mm
Net weight: 1.57 kg

Recommended liquid :
BUBBLE LIQUID 5L (B01911)

FIREFIGHTER'S SMOKE MACHINE



FT-200

Smoke machine - 1600 W designed for fire training

Code : B04881 999€^{Incl. VAT}



FT-100

Smoke machine - 1500 W designed for fire training

Code : B04880 699€^{Incl. VAT}



FT-20

Portable smoke machine 600 W on batteries designed for fire training

Code : B04882 999€^{Incl. VAT}



Heating element: 1600W
Preheating time: 7 minutes
Tank: 2.4 litres
Max. consumption 270 ml/min at 100%
Coverage: Height 8 metres
Control panel: LCD display
Volume and Timer Mode
DMX mode: 1 channel
Wireless W-2 remote included
Z-3 remote optional
Power supply: 230V - 50Hz
Power consumption: 1600 W max.
Dimensions: 301 x 194 x 414 mm
Net weight: 16 Kg

Recommended liquid :
FLP-6 (B04836)

Heating element: 1500W
Preheating time: 7,5 minutes
Tank: 6 litres
Max. consumption 100 ml/min at 100%
Output volume: 560 m3 per minute
Control panel: LCD display
Volume and Timer Mode
DMX mode: 1 channel
Wireless W-2 remote included
Z-3 remote optional
Power supply: 230V - 50Hz
Power consumption: 1500 W max.
Dimensions: 580 x 278 x 264 mm
Net weight: 14,6 Kg

Recommended liquid :
FLP-6 (B04836)

Heating element: 600W
Battery: DC 12V
Preheating time: 1 sec
Tank: 0.4 litres
Max. consumption 16 ml/min at 100%
Control panel:
Manual: on/off
DMX mode: 1 channel
WTR-20 optional
Z-3 remote optional
Charger: AC 230V - 50Hz / DC 12V
Power consumption: 600 W max.
Dimensions: 580 x 278 x 264 mm
Net weight: 14,6 Kg

Recommended liquid :
FLM-05 (B04839)



FT-20SE

Power base for smoke machine FT-20

Code : B04884 479€^{Incl. VAT}



WARNING

ONLY USE THE RECOMMENDED SMOKE LIQUIDS FOR YOUR MACHINES.

These liquids are compliant with the latest health and environmental regulations. These liquids have been specially tested for your machine and guarantee the best possible results.

These are the only liquids that guarantee long term operation, use of other liquids will damage your machine by clogging the heating element and wearing out the pump. Repairs for clogged heating elements will only be covered after expert evaluation. The warranty will only be valid if the recommended liquid was used.

FAN



BT-HURRICANE
DMX high power fan

Code : B04850 529€^{Incl. VAT}



CASE FOR BT-HURRICANE
Flight case for BT-Hurricane

Code : B03277 399€^{Incl. VAT}



Studio and stage fan controlled by DMX
Power: up to 3500m³/h or 58m³/min (2060 cfm)
Sound level:
30 dB minimum speed - 72 dB maximum speed
Air flow direction adjustable over 180°
Continuous adjustment of air flow
Control options:
DMX 1 channel (XLR 3&5 pins)
Wireless DMX (WTR-DMX DONGLE option)
Manual operation (LED display)
Power supply: 230V - 50Hz
Power consumption: 200W max.
Dimensions: 584 x 476 x 397mm
Net weight: 16.5 kg

PERFUMES AND LIQUIDS

Specific liquids				
Code	Designation	Type	Brand	
B04854	BT-LOWFOG LIQUID - Liquide pour BT-H2FOG - 5L	Heavy smoke	Briteq	19,90 € ^{Incl. VAT}
B04839	FLM-05 - Fog Liquid for FT-20 - 0.50L	Fireman Training	Antari	12,90 € ^{Incl. VAT}
B04836	FLP-6 - Fog Liquid for FT-100 (fire training) - 6L	Fireman Training	Antari	55,00 € ^{Incl. VAT}
B04837	HZL-5W - Water based Hazer Fluid - 5L	Water-based fog	Antari	73,90 € ^{Incl. VAT}
B04832	HZL-5 - Oil based Haze liquid - 5L	Fog	Antari	79,00 € ^{Incl. VAT}
H10491	MD6L - Liquide à fumée moyenne densité Hazetec - 6L	Fog	Contest	69,00 € ^{Incl. VAT}
B04810	FOG LIQUID STD 1L - Fogger liquid standard - 1L	Smoke fluid Standard	JB SYSTEMS	5,90 € ^{Incl. VAT}
B04811	FOG LIQUID STD 5L - Fogger liquid standard - 5L	Smoke fluid Standard	JB SYSTEMS	14,90 € ^{Incl. VAT}
B04838	FLG-5 - Heavy Fog Liquid - 5L (green)	High Density Smoke Liquid	Antari	35,90 € ^{Incl. VAT}
B04835	FOG LIQUID HI-TECH 1L - Fogger liquid Hi-Tech - 1L	High Density Smoke Liquid	JB SYSTEMS	9,49 € ^{Incl. VAT}
B04812	FOG LIQUID HI-TECH 1L - Fogger liquid Hi-Tech - 5L	High Density Smoke Liquid	JB SYSTEMS	21,90 € ^{Incl. VAT}
H9656	HD5L - Liquide à fumée haute densité - 5L	High Density Smoke Liquid	Contest	33,90 € ^{Incl. VAT}
B04834	FLC-5 - Superfast dissipating Fog for Jet Operation - 5L	Smoke Liquid Fast Dissipation	Antari	27,90 € ^{Incl. VAT}
B01911	BUBBLE LIQUID 5L - Liquid for bubble machine - 5L	Bubbles	JB SYSTEMS	15,90 € ^{Incl. VAT}
B04813	SNOW LIQUID 5L - Liquid for Snow machine - 5L	Snow	JB SYSTEMS	20,90 € ^{Incl. VAT}
B04852	SL-5H - Super Dry Snow Fluid - 5L	Snow	Antari	19,00 € ^{Incl. VAT}
B04830	FOAM LIQUID CC 5L - Concentrated foam liquid - 5L	Foam	JB SYSTEMS	43,90 € ^{Incl. VAT}
B04831	FOAM LIQUID CC 20L - Concentrated foam liquid - 20L	Foam	JB SYSTEMS	169,00 € ^{Incl. VAT}
Fragrance Additives				
Code	Designation	Type	Brand	
B04822	Fragrance - Apple - Pomme - Parfum liquide fumée	Perfume	JB SYSTEMS	4,79 € ^{Incl. VAT}
B04820	Fragrance - Coco - Coco - Parfum liquide fumée	Perfume	JB SYSTEMS	4,79 € ^{Incl. VAT}
B04823	Fragrance - Musk - Muscus - Parfum liquide fumée	Perfume	JB SYSTEMS	4,79 € ^{Incl. VAT}
B04821	Fragrance - Strawberry - Fraise - Parfum liquide fumée	Perfume	JB SYSTEMS	4,79 € ^{Incl. VAT}
B04825	Fragrance - Tutti Frutti - Parfum liquide fumée	Perfume	JB SYSTEMS	4,79 € ^{Incl. VAT}

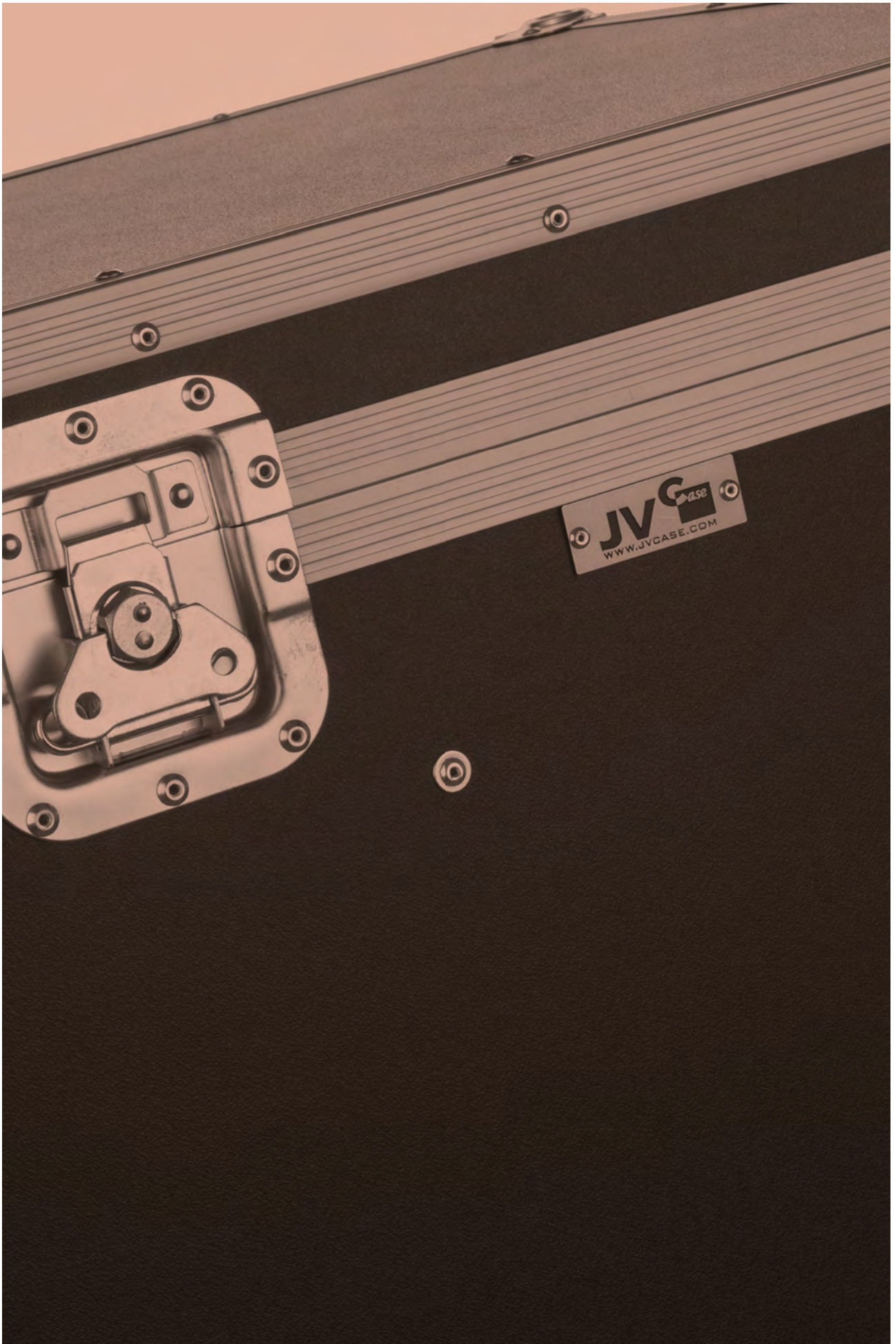

FLIGHT-CASES

AUDIO FLIGHT-CASES
FLIGHT-CASES FOR LIGHTS
19" RACKS

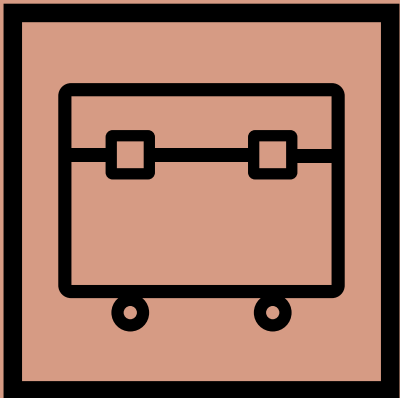

AUDIO FLIGHT-CASES



CASE FOR 2x SC-15
Flight-case for 2x SC-15.

Code : B03262 699€^{Incl. VAT}



CASE FOR 2x SC-12
Flight-case for 2x SC-12.

Code : B03261 519€^{Incl. VAT}



CASE FOR 4x SC-08
Flight-case for 4x SC-08

Code : B03260 639€^{Incl. VAT}



CASE FOR 8x SC-05
Flight-case for 8x SC-05

Code : B03259 569€^{Incl. VAT}



RACK CASE 10/18U
Convenient and versatile Flight-case.

Code : B03240 489€^{Incl. VAT}



**CARPET DJ MIXER
CASE 5U+11U**
Carpeted DJ Flight-case.

Code : B03200 109€^{Incl. VAT}



TT-CASE
High-quality modern flight-case for DJ
turntables (T2, T3, X-TRM1, SL1200, etc.).

Code : B03206 69€^{Incl. VAT}



**CASE FOR
LIVETOUCH20**
Flight case for LiveTouch20 mixer

Code : B03292 199€^{Incl. VAT}



MICRO CASE 3U
Standard 19" Flight-case 3U height,
reduced depth 230mm/300mm

Code : B03221 119€^{Incl. VAT}



Code : B03224 89€^{Incl. VAT}



Code : B03231 169€^{Incl. VAT}



FLIGHT-CASES FOR LIGHTS



MOVING HEAD CASE

4
Flight case for 2x BTX-CIRRUS

Code : B03288 729€^{Incl. VAT}



MOVING HEAD CASE

5
Flight case for 2x BTX-SATURN

Code : B03291 559€^{Incl. VAT}



WHEELSET FOR WHEEL BOARD

Wheelset with 2 wheels with brake

Code : B03287 74,90€^{Incl. VAT}



WHEEL BOARD 60x60CM

Wheel plate 60x60cm

Code : B03281 69€^{Incl. VAT}



WHEEL BOARD 80x60CM

Wheel plate 60x80cm

Code : B03282 99€^{Incl. VAT}



CASE FOR 4xACCU DECOLITE

Flight case for 4x Accu Decolite,

Code : B03279 179€^{Incl. VAT}



CASE-3

Flight case for 6x BT-AKKULITE IP /
ACCUCOLOR

Code : B03274 249€^{Incl. VAT}



MULTIPURPOSE CASE 1

Flight case 60x80cm with dividers

Code : B03278 439€^{Incl. VAT}



CASE FOR 2xBT-RETRO

Flightcase for 2 x BT-RETRO

Code : B03289 529€^{Incl. VAT}



CASE FOR 3xBT-BLINDER2 IP

Flightcase for 3 x BT-BLINDER2 I

Code : B03290 549€^{Incl. VAT}



PROJECTOR CASE 5

Flight case for 6 x BT-Theatre 50WW-60FC

Code : B03276 619€^{Incl. VAT}



Code : B03275 459€^{Incl. VAT}



FLIGHT-CASES FOR LIGHTS

NEW



CASE FOR 2xCHALLENGER BSW
Flightcase for 2x CHALLENGER BSW moving heads

Code : B03295 389€^{Incl. VAT}



NEW



CASE FOR 4 EFFECT BARS 1M
JV Case Flightcase for 4 effect bars like Sunbar White or Combi. Rave Bar

Code : B03294 379€^{Incl. VAT}



NEW



MOVING HEAD CASE 6
Flight case pour 4x Clubspot/Clubwash 2

Code : B03296 269€^{Incl. VAT}



PROJECTOR CASE 4
Case for 4x BT-Theatre 250EZ & 100 EC Mk2.

Code : B03285 649€^{Incl. VAT}



PROJECTOR CASE 3
Case for BT-Coloray/Stage-Pro Beamer/ Smar

Code : B03280 669€^{Incl. VAT}



CASE FOR 4xBT-NONABEAM
Flight case for 4 x BT-Nonabeam

Code : B03284 669€^{Incl. VAT}





CASE FOR 4xBT-LE-DROTOR
Flight case for 4 x BT-Ledrotor

Code : B03283 759€^{Incl. VAT}





CASE FOR BEAM WIZARD5x5
Flight-case for 2x BT-BEAM WIZARD

Code : B03256 569€^{Incl. VAT}

CASE FOR 2x BTX-TITAN
Flight-case for 2x BTX-TITAN

Code : B03251 649€^{Incl. VAT}

CASE for 4x BT-TRACKER
Flight-case for 4x BT-TRACKER.

Code : B03264 519€^{Incl. VAT}



FLIGHT-CASES FOR LIGHTS



**CASE for
6x BEAM FURY-1**
Flight-case for 6x BEAM FURY-1

Code : B03265 449€^{Incl. VAT}



MOVING HEAD CASE2
Flight-case for 4x BT-Orbit/BT-W19L10 ZOOM

Code : B03272 629€^{Incl. VAT}



CASE FOR 4x STRIKER
Flight-case for 4x STRIKER

Code : B03267 289€^{Incl. VAT}



**CASE FOR
2x BTX-HAWK**
Flight-case for 2x Briteq BTX-HAWK

Code : B03263 439€^{Incl. VAT}



MOVING HEAD CASE1
Flight-case for 2x BT-METEOR, BT-70LS, BT-BEAM70

Code : B03255 269€^{Incl. VAT}



LIGHT EFFECT CASE 4
Flight-case for 2x LYNX, 2x BT-20LS, 2x BT-30FC or 2x BT-W12L10 ZOOM

Code : B03225 199€^{Incl. VAT}



LIGHT EFFECT CASE 1
Flight-case for light effects.

Code : B03216 219€^{Incl. VAT}



LIGHT EFFECT CASE 3
Flight-case for light effects (e.g. 2x LED CLUBSCAN OR 2x DYNAMO scan)

Code : B03223 89€^{Incl. VAT}



LIGHT EFFECT CASE 7
Flight-case for The Winner II, Led Victoryscan, Led Spinner

Code : B03233 129€^{Incl. VAT}



PROJECTOR CASE
Flight-case for 4x projectors with clamps

Code : B03253 349€^{Incl. VAT}



PROJECTOR CASE 2
Flight-case for POWERPIXEL8-RGB, POWERPIXEL4-RGB, BEAMBAR10-RGBW, BEAMBAR5-RGBW

Code : B03257 649€^{Incl. VAT}



FLIGHT-CASES FOR LIGHTS



CASE FOR COB-4BAR

Lightweight and compact case, specially designed to carry a COB-4BAR

Code : B03249 159€Incl. VAT



FLY-irLED64x6

Flight-case for 6x PAR64

Code : H10338 399€Incl. VAT



FLY8-irLEDFLAT

Flight-case for 8x FLAT12SIX

Code : H10739 399€Incl. VAT



CASE for 4x COB-PLANO

4x COB-PLANO + LEDCON-02 Mk2

Code : B03252 129€Incl. VAT



FLY-IPairx6

Flight-case for 6x IPair5x12Six

Code : H10464 349€Incl. VAT



FLY4IPANEL

Flight-case for 4 IPANEL24x100C

Code : H10866 549€Incl. VAT



CASE for 2x BT-VINTAGE

Flight-case for 2x BT-VINTAGE

Code : B03271 729€Incl. VAT



MATRIX5x5-CASE

Flight-case for 6x MATRIX5x5

Code : B04422 359€Incl. VAT



FLY-HAZETEC

Flight-case for HAZETEC

Code : H10510 229€Incl. VAT



CABLE CASE

Extra solid Flight-case specially designed to carry cables and other heavy objects.

Code : B03244 699€Incl. VAT

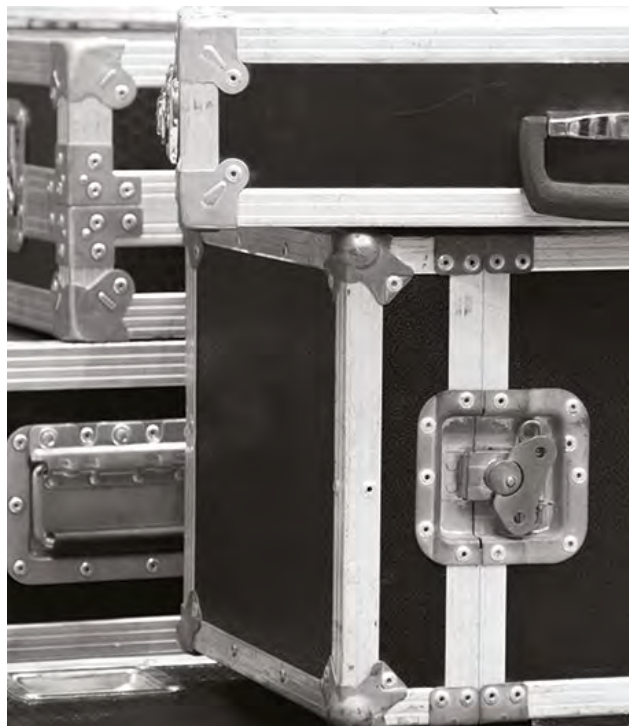

19" RACK



RACK CASE 16U

Standard 19" Flight-case 16U height, castors included

Code : B03211 259€^{Incl. VAT}



RACK CASE 12U

Standard 19" Flight-case 12U height, castors included

Code : B03210 239€^{Incl. VAT}



DJ CASE 10/6U

Standard 19" Flight-case 6U height + 10U top

Code : B03227 199€^{Incl. VAT}



PRO 445-4U

Standard 19" Flight-case 4U height+ 10U top

Code : B03222 199€^{Incl. VAT}



RACK CASE 8U

Standard 19" Flight-case 8U height

Code : B03209 129€^{Incl. VAT}



RACK CASE 6U

Standard 19" Flight-case 6U height

Code : B03219 119€^{Incl. VAT}



RACK CASE 4U

Standard 19" Flight-case 4U height

Code : B03208 99€^{Incl. VAT}



RACK CASE 2U

Standard 19" Flight-case 2U height

Code : B03212 89€^{Incl. VAT}



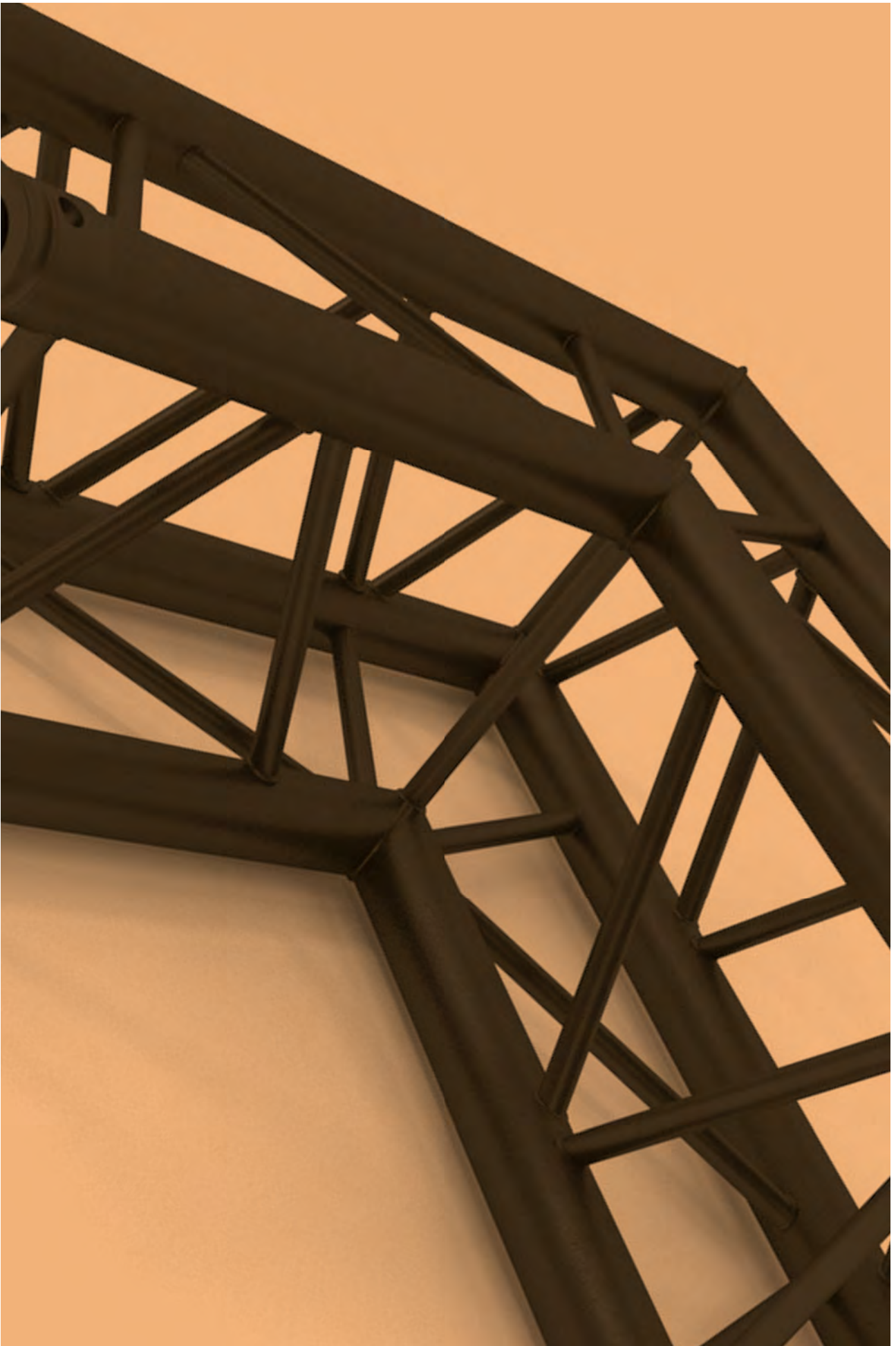

TRUSSS

SQUARE:

QUATRO HEAVY DUTY

QUA29

TRIANGULAR :

PT29

LADDER :

DU029

TUBE:

UNO

DEC022Q

DEC022T

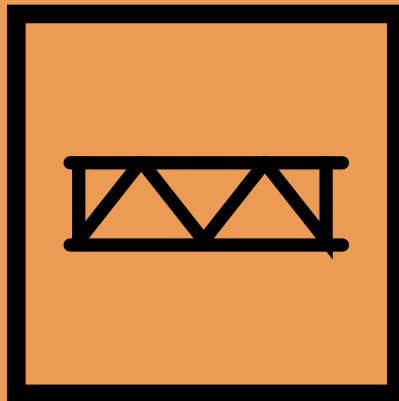

QUATRO290 - HEAVY DUTY



Manufacture according to DIN ISO 4113 and TÜV standards.
Aluminium alloy truss (EN AW 6082 T6) 48.3 mm in diameter and 3 mm thick

New dimensions, structure and squares in order to be able to stick as well as possible to your requirements.
Truss 25cm / 75cm and squares 50x50x50 cm

- Tubes with a diameter of 48.3 mm and a thickness of 3 mm
- 16 mm threads
- Delivered with assembly sleeves

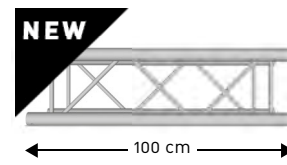
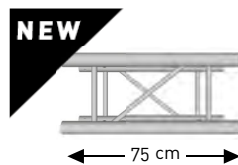
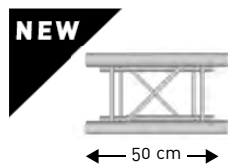
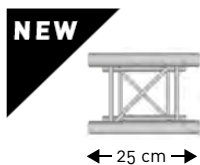

QUATRO-025
Square aluminium truss - Heavy duty - 290 mm - Length 25 cm

Code : H11118 119€^{Incl. VAT}

Weight : 3,5 kg

QUATRO-050
Square aluminium truss - Heavy duty - 290 mm - Length 50 cm

Code : H11119 139€^{Incl. VAT}

Weight : 2,8 kg

QUATRO-075
Square aluminium truss - Heavy duty - 290 mm - Length 75 cm

Code : H11120 179€^{Incl. VAT}

Weight : 4,35 kg

QUATRO-100
Square aluminium truss - Heavy duty - 290 mm - Length 100 cm

Code : H11121 199€^{Incl. VAT}

Weight : 4,9 kg

QUATRO-200
Square aluminium truss - 290 mm Length 200 cm - Heavy duty

Code : H11122 309€^{Incl. VAT}

Weight : 9,1 kg

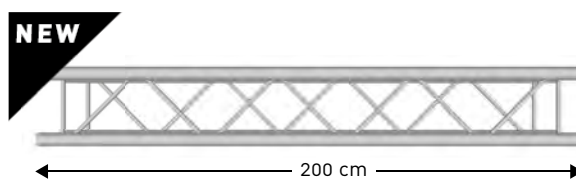

QUATRO-300
Square aluminium truss - 290 mm Length 300 cm - Length 200 cm - Heavy duty

Code : H11123 429€^{Incl. VAT}

Weight : 13,4 kg

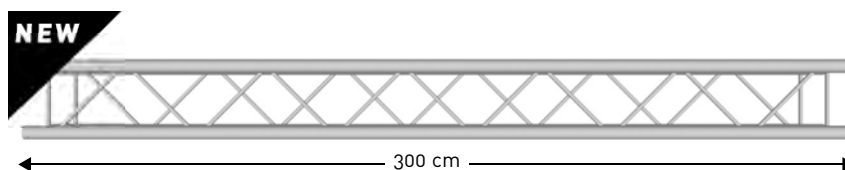

The CONTEST® truss comes with :
• 1 connection kit per bar

LENGTH (M)	↔	4	6	8	10	12	14	16
Max centred load (kg)	▼	1632	1077	797.1	626.1	510	425.2	360.5
Deformation (mm)	⌒	12.4	27.9	49.9	78.5	114	156.7	206.9
Max distributed load (kg/m)	▼▼▼	447.5	295.9	199.3	125.2	85	60.7	45
Deformation (mm)	⌒	8.5	28.7	61.9	96.9	139.8	190.9	250.1

The load tables show the weight limits supported between two fixed hook points.
Centred or distributed loads cannot be added together. Consult a qualified technician.

QUATRO29 - HEAVY DUTY



NEW

QUATRO-A01
Angle alu square 290 - Heavy duty - 2x 90° directions with sleeves

Code : H11124 229€^{Incl. VAT}

NEW

QUATRO-A02
Angle alu square 290 - Heavy duty - 3x 90° directions with sleeves

Code : H11125 369€^{Incl. VAT}

NEW

QUATRO-A03
Angle alu square 290 - Heavy duty - 3x 90° directions with sleeves

Code : H11126 349€^{Incl. VAT}

NEW

QUATRO-A04
Angle alu square 290 - Heavy duty - 4x 90° directions with sleeves

Code : H11127 349€^{Incl. VAT}

NEW

QUATRO-ABOX
Angle alu square 290 - Heavy duty - 6x directions 90° without sleeve

Code : H11128 399€^{Incl. VAT}

UNO-1/2MANCH
Additional half coupler for QUATRO-ABOX CUBE

Code : H10254 12€^{Incl. VAT}

MCQUA-KIT
Set of 4 conical couplers, 8 spigot pins and 8 Safety R-springs

Code : H10063 45€^{Incl. VAT}

1/2MANCH
Taper half-sleeve with thread M12 (H=12mm) for EM29BLOU

Code : H6530 9€^{Incl. VAT}

EMQUA-B1
Quatro aluminium baseplate with couplers, keys and pins. 290x290 mm

Code : H10064 79€^{Incl. VAT}

EM29BLOU40D90
40 kg heavy baseplate for TRIO/QUATRO 290 of 90 cm diam

Code : H10835 349€^{Incl. VAT}

EM29BLOU29D74
Heavy baseplate for TRIO/QUATRO 29 diam 74 cm - 29kg

Delivered without sleeves
Ref sleeves: 1/2HANDLE code: H6530

Code : H10463 299€^{Incl. VAT}

BT-TRUSS Q/T 29 BASE80
41 Kg heavy baseplate for Trio/Quat 290 with half-couplers, 800 x 800 mm

Code : B03684 269€^{Incl. VAT}



QUATRO29 SQUARE 290 SILVER



Manufacture according to DIN ISO 4113 and TÜV standards.
Aluminium alloy truss (EN AW 6082 T6) 50 mm in diameter and 2 mm thick

50 mm tubes
16 mm braces
Square section with 240 mm spacing between each tube (290 mm exterior)

Assembly with conical coupler, spigot pin and Safety R-springs
Section: 290 mm

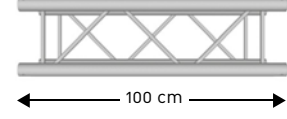
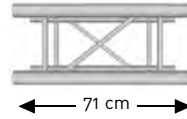
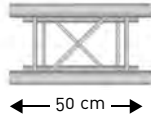
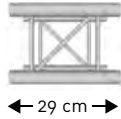

QUA29-029
Square aluminium truss - 290 mm
Length 29 cm

Code : H10118 129€^{Incl. VAT}

Weight : 3,5 kg

QUA29-050
Square aluminium truss - 290 mm
Length 50 cm

Code : H10049 139€^{Incl. VAT}

QUA29-071
Quatro aluminium truss - 290 mm
Length 71 cm

Code : H10593 169€^{Incl. VAT}

Weight : 4,35 kg

QUA29-100
Square aluminium truss - 290 mm
Length 100 cm

Code : H10050 189€^{Incl. VAT}

QUA29-200
Square aluminium truss - 290 mm
Length 200 cm

Code : H10051 269€^{Incl. VAT}

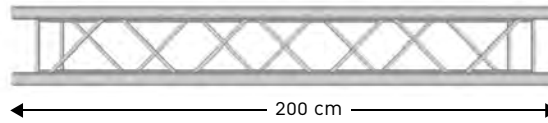

QUA29-300
Square aluminium truss - 290 mm
Length 300 cm

Code : H10052 349€^{Incl. VAT}

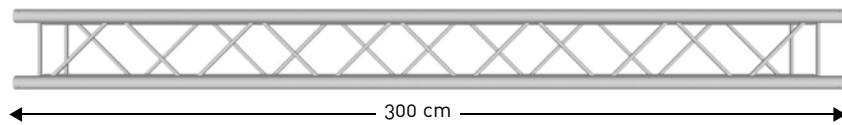

The CONTEST® truss comes with :

- 1 connection kit per bar

LENGTH (M)	↔	4	6	8	10	12	14	16
Max centred load (kg)	▼	1177	776.8	574.2	450.8	366.9	305.6	258.5
Deformation (mm)	⤵	12.3	27.9	49.8	78.4	113.8	156.4	206.6
Max distributed load (kg/m)	▼▼▼	449.5	258.9	143.6	90.2	61.2	43.7	32.3
Deformation (mm)	⤵	11.8	34.7	61.7	96.6	139.5	190.4	249.5

The load tables show the weight limits supported between two fixed hook points.
Centred or distributed loads cannot be added together. Consult a qualified technician.

QUATRO29 SQUARE 290 BLACK



Manufacture according to DIN ISO 4113 and TÜV standards.
Aluminium alloy truss (EN AW 6082 T6) 50 mm in diameter and 2 mm thick

50 mm tubes
16 mm braces
Square section with 240 mm spacing between each tube (290 mm exterior)
Assembly with conical coupler, spigot pin and Safety R-springs
Section: 290 mm
Matt black epoxy paint very resistant.



←29 cm→

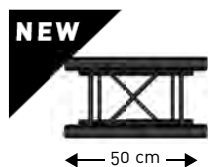

←50 cm→

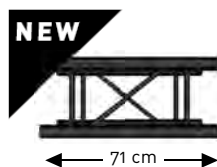

←71 cm→

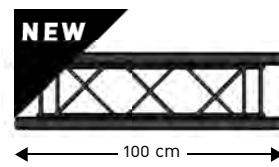

←100 cm→

QUA29-029 blk
Quatro aluminium 290mm length 29cm black

Code : H11007 149€^{Incl. VAT}

QUA29-050 blk
Quatro aluminium 290mm length 50cm black

Code : H11008 169€^{Incl. VAT}

QUA29-071 blk
Quatro aluminium 290mm length 71cm black

Code : H11009 179€^{Incl. VAT}

QUA29-100 blk
Quatro aluminium 290mm length 100cm black

Code : H11010 199€^{Incl. VAT}

QUA29-200 blk
Quatro aluminium 290mm length 200cm black

Code : H11011 289€^{Incl. VAT}

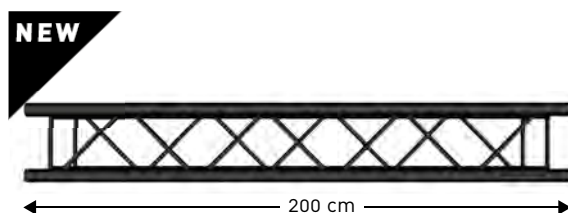

←200 cm→

QUA29-300 blk
Quatro aluminium 290mm length 300cm black

Code : H11012 379€^{Incl. VAT}

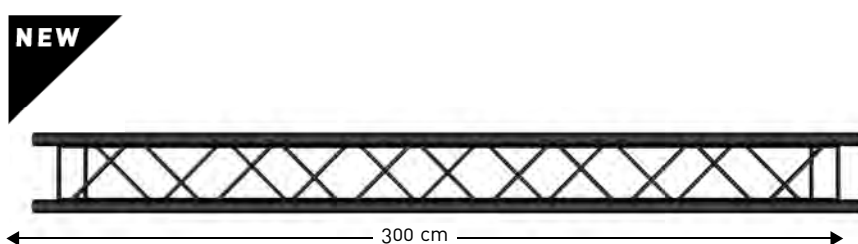

←300 cm→

The CONTEST® truss comes with :
• 1 connection kit per bar

LENGTH (M)	←→	4	6	8	10	12	14	16
Max centred load (kg)	▼	1177	776.8	574.2	450.8	366.9	305.6	258.5
Deformation (mm)	⌒	12.3	27.9	49.8	78.4	113.8	156.4	206.6
Max distributed load (kg/m)	▼▼▼	449.5	258.9	143.6	90.2	61.2	43.7	32.3
Deformation (mm)	⌒	11.8	34.7	61.7	96.6	139.5	190.4	249.5

The load tables show the weight limits supported between two fixed hook points.
Centred or distributed loads cannot be added together. Consult a qualified technician.



QUA29 SQUARE 290 SILVER



The CONTEST® truss comes with :

- 1 x connection kit, angle - 2 directions
- 2 x connection kits, angle - 3, 4 and 5 directions

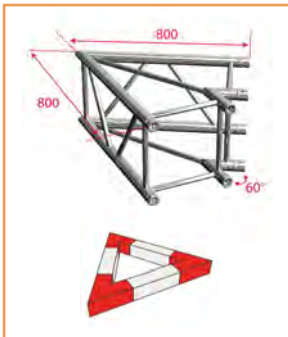

AGQUA-01
Quatro angle - 80 cm 60° - 2 directions

Code : H10053 209€^{Incl. VAT}

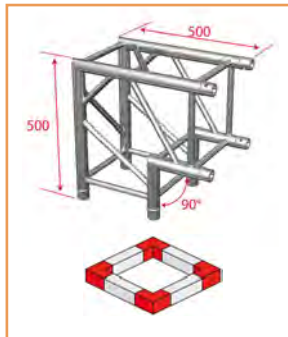

AGQUA-02
Quatro angle - 50 cm 90° - 2 directions

Code : H10054 189€^{Incl. VAT}

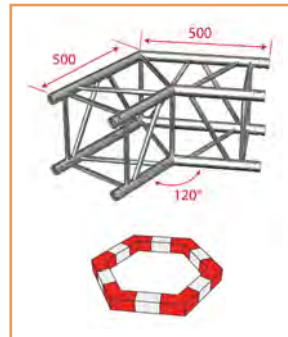

AGQUA-03
Quatro angle - 50 cm 120° - 2 directions

Code : H10055 189€^{Incl. VAT}

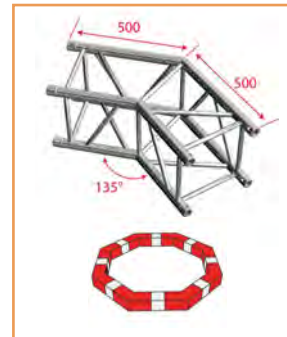

AGQUA-04
Quatro angle - 50 cm 135° - 2 directions

Code : H10056 189€^{Incl. VAT}

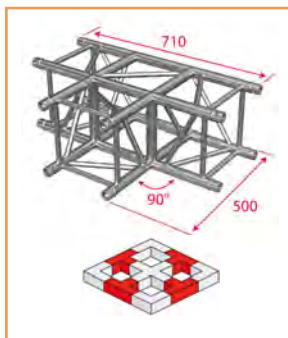

AGQUA-05
Quatro angle - 90° - 3 directions

Code : H10057 289€^{Incl. VAT}

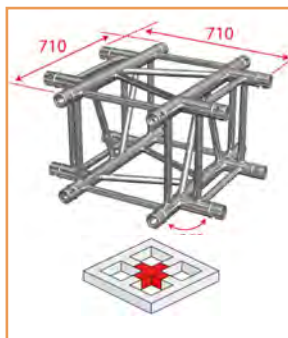

AGQUA-06
Quatro angle - 90° - 4 directions

Code : H10058 359€^{Incl. VAT}

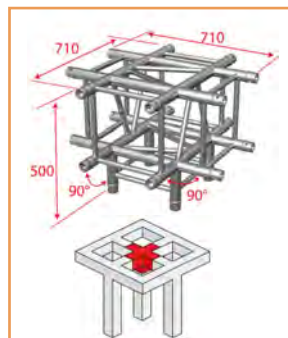

AGQUA-07
Quatro angle - 90° - 5 directions

Code : H10059 429€^{Incl. VAT}

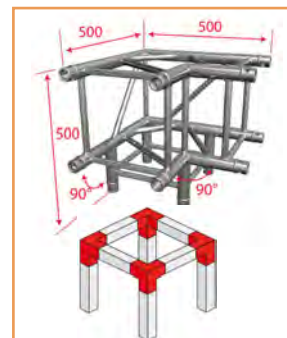

AGQUA-09
Quatro side piece - 3 directions

Code : H10061 289€^{Incl. VAT}

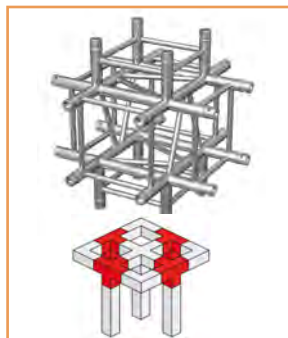

AGQUA-10
Quatro side piece - 4 directions

Code : H10062 379€^{Incl. VAT}



QUA29 SQUARE 290 BLACK



The CONTEST® truss comes with :

- 1 x connection kit, angle - 2 directions
- 2 x connection kits, angle - 3, 4 and 5 directions



AGQUA-01 blk
Quatro angle 2 directions 100cm 60° black

Code : H11001 369€^{Incl. VAT}



AGQUA-02 blk
Quatro angle 2 directions 50cm 90° black

Code : H10997 199€^{Incl. VAT}



AGQUA-03 blk
Quatro angle - 50 cm 120° - 2 directions

Code : H11005 329€^{Incl. VAT}



AGQUA-04 blk
Quatro angle - 50 cm 135° - 2 directions

Code : H11006 229€^{Incl. VAT}



AGQUA-05 blk
Quatro angle 3 directions 90° black

Code : H11000 269€^{Incl. VAT}



AGQUA-06 blk
Quatro 4 directions black junction

Code : H10999 349€^{Incl. VAT}



AGQUA-07 blk
Quatro angle - 90° - 5 directions

Code : H11004 499€^{Incl. VAT}



AGQUA-08 blk
Quatro angle - 90° - 6 directions

Code : H11003 529€^{Incl. VAT}



AGQUA-09 blk
Quatro 3 directions black

Code : H10998 299€^{Incl. VAT}



AGQUA-10 blk
Quatro side piece - 90° - 4 directions

Code : H11002 359€^{Incl. VAT}



QUA29 SQUARE 290

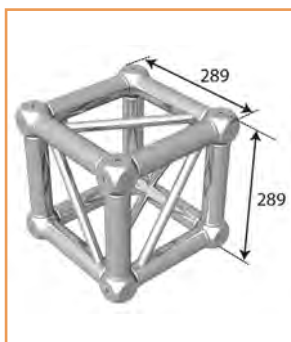

AGCUB290

Connection cube for 290 mm square truss

Code : H10433 399€^{Incl. VAT}



UNO-1/2MANCH

Additional half coupler for cube AGCUB290

Code : H10254 12€^{Incl. VAT}



MCQUA-KIT

Set of 4 conical couplers, 8 spigot pins and 8 Safety R-springs

Code : H10063 45€^{Incl. VAT}



1/2MANCH

Taper half-sleeve with thread M12 (H=12mm) for EM29BLOU

Code : H6530 9€^{Incl. VAT}



EMQUA-B1

Quatro aluminium baseplate with couplers, keys and pins. 290x290 mm

Code : H10064 79€^{Incl. VAT}



EMQUA-B1 BLK

Quatro baseplate - With connectors - Black finishing. 290x290 mm

Code : H11013 89€^{Incl. VAT}



TOT-BASEtop

Upper baseplate for Totem with 4 half-couplers

Code : H10256 89€^{Incl. VAT}



TOT-BASEground

Floor baseplate for Totem with 4 half-couplers

Code : H10255 119€^{Incl. VAT}



EM29BLOU40D90

40 kg heavy baseplate for TRIO/QUATRO 290 of 90 cm diam

Code : H10835 349€^{Incl. VAT}



Delivered without half-sleeves
Ref : 1/2MANCH code: H6530

EM29BLOU29D74

Heavy baseplate for TRIO/QUATRO 290 of 74 cm diam - 29kg

Code : H10463 299€^{Incl. VAT}



BT-TRUSS Q/T 29 BASE80

41 Kg heavy baseplate for Trio/Quat 290 with half-couplers, 800 x 800 mm

Code : B03684 269€^{Incl. VAT}



SWALL290

Wall mount for 290 truss

Code : H11129 249€^{Incl. VAT}



PT29 TRIANGULAR 290 SILVER



Manufacture according to DIN ISO 4113 and TÜV standards.
Aluminium alloy truss (EN AW 6082 T6) 50 mm in diameter and 2 mm thick.

50 mm tubes
16 mm braces
Triangular section with 240 mm spacing between each tube (290 mm exterior)

Assembly with conical coupler, spigot pin and Safety R-springs
Average weight per metre: 4.5 kg
Section: 290 mm

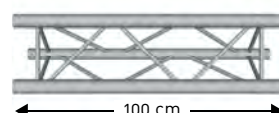
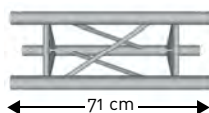
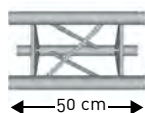

PT29-029
Aluminium truss - 290 mm
Length 29 cm

Code : H4213 99€^{Incl. VAT}

PT29-050
Aluminium truss - 290 mm
Length 50 cm

Code : H3247 109€^{Incl. VAT}

PT29-071
Trio aluminium truss - 290 mm
Length 71 cm

Code : H10592 129€^{Incl. VAT}

PT29-100
Aluminium truss - 290 mm
Length 100 cm

Code : H3248 139€^{Incl. VAT}

PT29-200
Aluminium truss - 290 mm
Length 200 cm

Code : H3249 199€^{Incl. VAT}

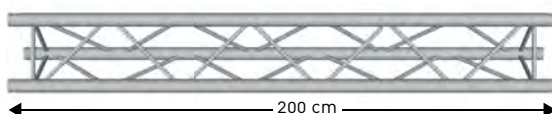

PT29-300
Aluminium truss - 290 mm
Length 300 cm

Code : H3250 259€^{Incl. VAT}

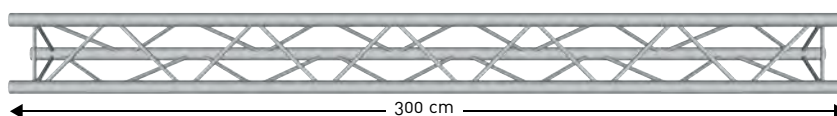

The CONTEST® truss comes with :

- 1 connection kit per bar

LENGTH (M)		2	4	6	8	10	12
Max centred load (kg)		1023.9	506.4	331.5	242.2	187.2	149.2
Deformation (mm)		2.6	10.6	24	43.1	68.2	99.6
Max distributed load (kg/m)		783.1	253.2	110.5	60.6	37.4	24.9
Deformation (mm)		2.5	13.2	29.8	53	83.2	120.3

The load tables show the weight limits supported between two fixed hook points.
Centred or distributed loads cannot be added together. Consult a qualified technician.



PT29 TRIANGULAR 290 SILVER

- The CONTEST® truss comes with :
- 1 x connection kit, angle – 2 directions
 - 2 x connection kits, angle – 3, 4 and 5 directions

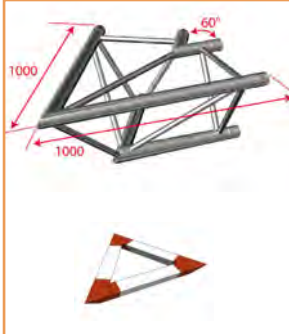

AG29-020

Angle - 290 mm 60° - 2 directions -

Code : H7015

169€Incl. VAT



AG29-021

Angle - 290 mm 90° - 2 directions -

Code : H3251

139€Incl. VAT

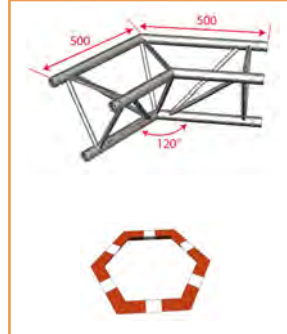

AG29-022

Angle - 290 mm 120° - 2 directions -

Code : H7016

139€Incl. VAT

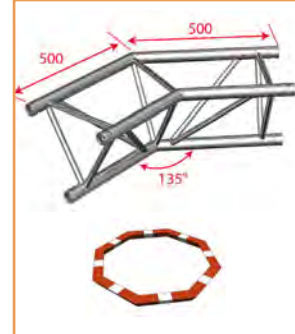

AG29-023

Angle - 290 mm 135° - 2 directions -

Code : H3252

129€Incl. VAT



AG29-025

Angle - 290 mm 90° - 2 directions -
Inner vertex

Code : H3253

139€Incl. VAT



AG29-033

Angle - 290 mm 90° - 3 directions - Lower
upright vertex

Code : H3254

229€Incl. VAT



AG29-034

Angle - 290 mm 90° - 3 directions -
Lower left-hand vertex

Code : H3255

229€Incl. VAT

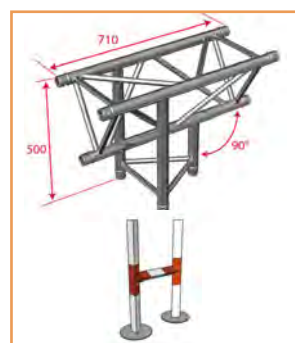

AG29-035

Vertical tee - 290 mm - 3 directions - Lower
vertex

Code : H3256

229€Incl. VAT



AG29-036

Horizontal tee - 290 mm 90° - 3 directions

Code : H3257

229€Incl. VAT

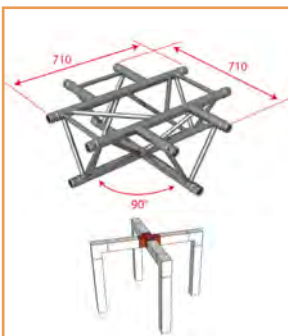

AG29-041

Cross - 290 mm - 4 directions

Code : H3258

249€Incl. VAT

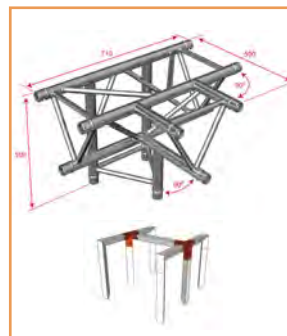

AG29-042

Tee - 290 mm - 4 directions - Apex down

Code : H3259

269€Incl. VAT

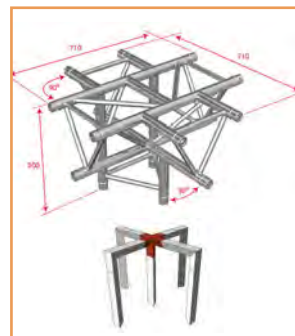

AG29-053

Cross - 290 mm - 4 directions plus base

Code : H4212

389€Incl. VAT



PT29 TRIANGULAR 290 SILVER



MC29-KIT

Set of 3 conical couplers, 6 spigot pins and 6 Safety R-springs

Code : H3261

35€^{Incl. VAT}



MANCH

Single conical sleeve for PT29 structure

Code : H6523

12€^{Incl. VAT}



CLAV

Spigot pin for MANCH

Code : H6524

2,30€^{Incl. VAT}



CLAV

Spigot pin for MANCH

Code : H6525

0,50€^{Incl. VAT}

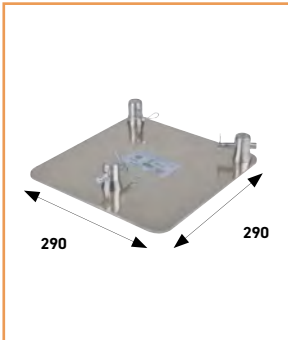

EM29-B3

Triangular truss baseplate - 290 mm with conical couplers, spigot pins and Safety R-springs

Code : H8884

69€^{Incl. VAT}



EM29-B3T

Light triangular baseplate for PT29

Code : H10833

45€^{Incl. VAT}



EM29BLOU29D74

Heavy baseplate for TRIO/QUATRO 290 of 74 cm diam - 29kg

Code : H10463

299€^{Incl. VAT}



EM29BLOU40D90

Heavy baseplate for TRIO/QUATRO 290 of 74 cm diam - 29kg

Code : H10835

349€^{Incl. VAT}



BT-TRUSS Q/T 29 BASE80

41 Kg heavy baseplate for Trio/Quat 290 with half-couplers, 800 x 800 mm

Code : B03684

269€^{Incl. VAT}



NEW

SWALL290

Wall mount for 290 truss

Code : H11129

249€^{Incl. VAT}



LADDER 290 SILVER



Manufacture according to DIN ISO 4113 and TÜV standards.
Aluminium alloy truss (EN AW 6082 T6) 50 mm in diameter and 2 mm thick.

50 mm tubes
16 mm braces
Ladder with 240 mm spacing between each tube (290 mm exterior)

Assembly with conical coupler, spigot pin and Safety R-spring
Section: 290 mm

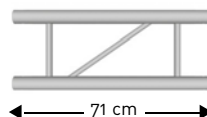
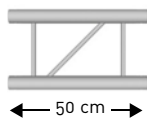
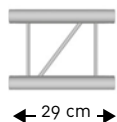

DU029-029

290 mm aluminium ladder - Length 29 cm

Code : H10036

69€^{Incl. VAT}



DU029-050

290 mm aluminium ladder
Length 50 cm

Code : H10037

79€^{Incl. VAT}



DU029-071

290 mm aluminium ladder
Length 71 cm

Code : H10607

85€^{Incl. VAT}



DU029-100

290 mm aluminium ladder
Length 100 cm

Code : H10038

95€^{Incl. VAT}

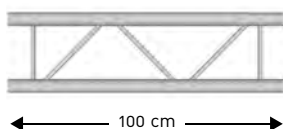

The CONTEST® truss comes with :
• 1 connection kit per bar

WARNING! LADDER 290 CONTESTAGE IS NOT COMPATIBLE WITH THE OLD BRITEQ BT-TRUSS DUO STRUCTURE.

DU029-200

290 mm aluminium ladder
Length 200 cm

Code : H10039

119€^{Incl. VAT}

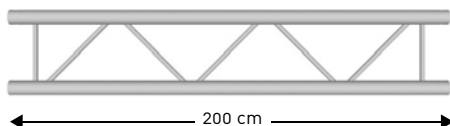

DU029-300

290 mm aluminium ladder
Length 300 cm

Code : H10040

149€^{Incl. VAT}

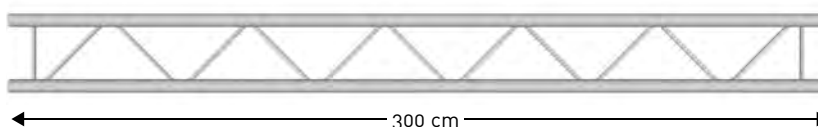

LENGTH (M)		2	3	4	5	6
Max centred load (kg)		904.3	787.9	589.1	469.4	389.2
Deformation (mm)		2.4	6.9	12.3	19.3	27.8
Max distributed load (kg/m)		452.2	300.7	225.0	179.6	129.7
Deformation (mm)		1.5	5.0	11.8	23.0	34.6

The load tables show the weight limits supported between two fixed hook points.

Centred or distributed loads cannot be added together. Consult a qualified technician.

The CONTEST® truss comes with :

- 1 x connection kit, angle – 2 directions
- 2 x connection kits, angle - 2, 3, 4 directions

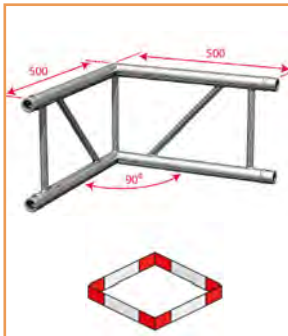

AGDU029-01

Corner joint - 2 directions - 90° - upright

Code : H10041

119€^{Incl. VAT}

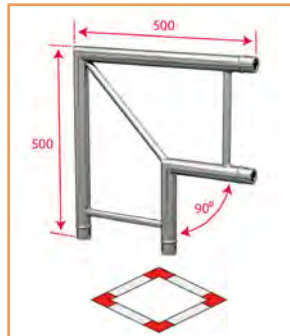

AGDU029-02

Corner joint - 2 directions - 90° - flat

Code : H10042

109€^{Incl. VAT}

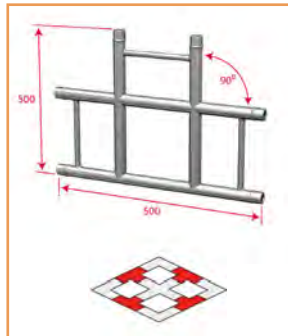

AGDU029-03

Corner joint - 3 directions - 90° - flat

Code : H10043

139€^{Incl. VAT}

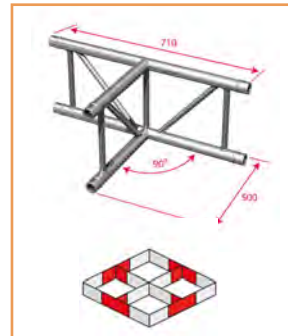

AGDU029-04

Corner joint - 3 directions - 90° - upright

Code : H10044

149€^{Incl. VAT}

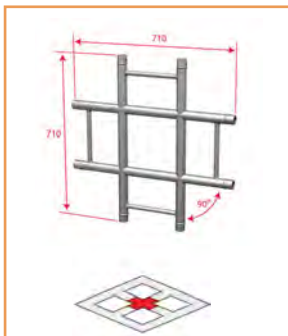

AGDU029-05

Corner joint - 4 directions - 90° - flat

Code : H10045

169€^{Incl. VAT}

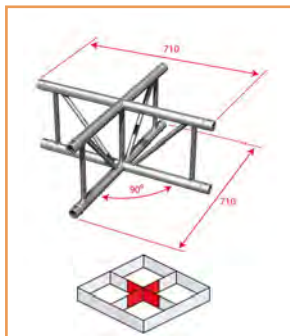

AGDU029-06

Corner joint - 4 directions - 90° - upright

Code : H10046

189€^{Incl. VAT}



AGDU0-07

Corner joint - 3 directions - 90° - upright

Code : H10863

119€^{Incl. VAT}

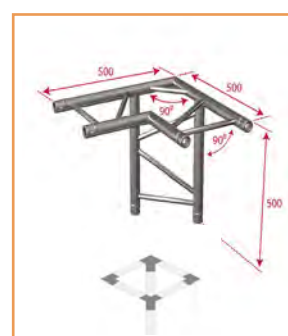

AGDU0-08

Corner joint - 3 directions - 90° - upright

Code : H10864

139€^{Incl. VAT}



AGDU0-09

Tee - 4 directions - 90° - flat

Code : H10865

119€^{Incl. VAT}



EMDU0-B1

DUO baseplate 290 mm with conical couplers, spigot pins and Safety R-springs

Code : H10048

49€^{Incl. VAT}



MCDU0-KIT

With 2 conical couplers, 4 spigot pins and 4 Safety R-springs

Code : H10047

25€^{Incl. VAT}



SSL-Duo

Support for DUO29 ladder on 35 mm base

Code : H10609

45€^{Incl. VAT}



TUBE UNO DIAMETER 50MM SILVER

- The CONTEST® truss comes with :
- 1x coupler per tube
 - 2x coupler per angle



UNO-50
Aluminium tube Diameter 50 mm
length 50 cm

Code : H10238 35€^{Incl. VAT}



UNO-100
Aluminium tube Diameter 50 mm
length 100 cm

Code : H10239 39€^{Incl. VAT}



UNO-150
Aluminium tube Diameter 50 mm
length 150 cm

Code : H10240 46€^{Incl. VAT}



UNO-200
Aluminium tube Diameter 50 mm
length 200 cm

Code : H10241 55€^{Incl. VAT}



UNO-50B
Aluminium tube Diameter 50 mm
length 50 cm-Black

Code : H10417 39€^{Incl. VAT}



UNO-100B
Aluminium tube Diameter 50 mm
length 100 cm-Black

Code : H10418 49€^{Incl. VAT}



UNO-150B
Aluminium tube Diameter 50 mm
length 150 cm-Black

Code : H10419 55€^{Incl. VAT}



UNO-200B
Aluminium tube Diameter 50 mm
length 200 cm-Black

Code : H10420 65€^{Incl. VAT}





UNO-AG01v2
Angle for tube Diameter 50 mm UNO +
2 x 1/2 coupler + spigot pin

Code : H10612 45€^{Incl. VAT}



UNO-1/2MANCH
Additional half coupler for angle UNO-AG01

Code : H10254 12€^{Incl. VAT}



1/2MANCH
Taper half-sleeve with thread M12
(H=12mm) for EM29BLOU

Code : H6530 9€^{Incl. VAT}



EM29BLOU29D74
Heavy baseplate for TRIO/QUATRO 290 of
74 cm diam - 29kg

Code : H10463 299€^{Incl. VAT}



UNO-A
Suspension bracket for projector for 50 mm
tube. L 188 mm H 240 mm

Code : H10336 45€^{Incl. VAT}



UNO-T
Suspension T for hanging projectors
50 mm tube

Code : H10334 79€^{Incl. VAT}



UNO-H
H-Frame for hanging projectors
50 mm tube

Code : H10335 119€^{Incl. VAT}

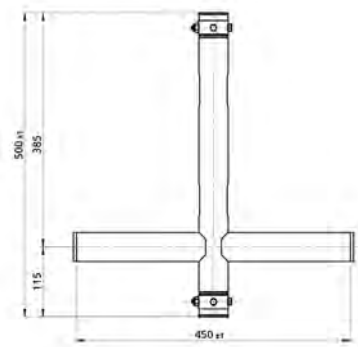
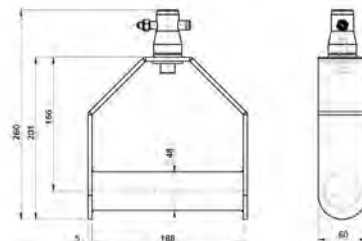

TOT-BAGUN04x100
Carrying case for 4 tubes UNO-100

Code : H11134 24€^{Incl. VAT}



TOT-BAGUN04x150
Carrying case for 4 tubes UNO-150

Code : H11135 30€^{Incl. VAT}



TOT-BAGUN04x200
Carrying case for 4 tubes UNO-200

Code : H11136 32€^{Incl. VAT}

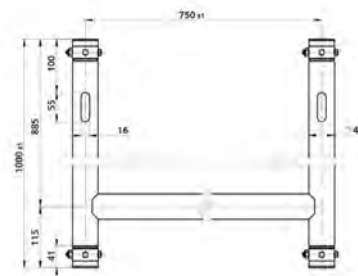

DECO22Q SQUARE 220 SILVER



Manufacture according to DIN ISO 4113 and TÜV standards.
Aluminium alloy truss (EN AW 6082 T6) 35 mm in diameter and 1,5 mm thick.

35 mm tubes
8 mm braces
Triangular section with 185 mm spacing between each tube (220 mm exterior)

Assembly with conical coupler, spigot pin and Safety R-springs
Section: 220 mm

DECO22Q-PT50
220mm aluminium square truss - Length: 50 cm

Code : H10218 99€^{Incl. VAT}



DECO22Q-PT100
220mm aluminium square truss - Length: 100 cm

Code : H10219 149€^{Incl. VAT}



DECO22Q-PT200
220mm aluminium square truss - Length: 200 cm

Code : H10220 219€^{Incl. VAT}

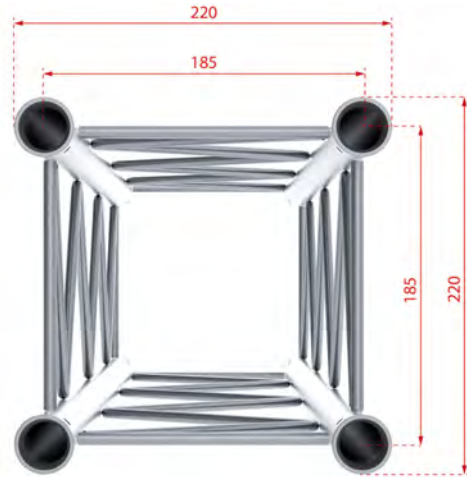

The CONTEST® truss comes with :

- 1 connection kit per bar
- 1 x connection kit, angle - 2 directions
- 2 x connection kits, angle - 3 and 4 directions

LENGTH (M)		2	3	4	5	6
Max centred load (kg)		439,1	334,6	248,5	196,4	161,1
Deformation (mm)		1,9	4,9	8,7	13,7	19,8
Max distributed load (kg/m)		219,5	145,4	108,4	78,5	53,7
Deformation (mm)		1,2	4	9,5	16,9	24,4

The load tables show the weight limits supported between two fixed hook points.
Centred or distributed loads cannot be added together. Consult a qualified technician.

DECO22Q CARRÉ 220 SILVER



DEC022Q-AG01
220 mm Quatro angle - 2 directions
90° - 50 cm

Code : H10221 179€^{Incl. VAT}



DEC022Q-AG02
220 mm Quatro side piece - 3 directions
90° - 50 cm

Code : H10222 209€^{Incl. VAT}



DEC022Q-AG03
220 mm Quatro side piece - 3 directions
90° - 50 cm

Code : H10223 209€^{Incl. VAT}



DEC022Q-MC-KIT
DECO series assembling kit

Code : H10224 49€^{Incl. VAT}



DEC022-MANCH
Conical coupler for Deco series aluminium
truss

Code : H10226 5,50€^{Incl. VAT}



DEC022-CLAV
Spigot pin for conical coupler DEC022 series
by unit

Code : H10227 3€^{Incl. VAT}



DEC022-GOUP
Safety R-spring for spigot pin

Code : H10228 0,80€^{Incl. VAT}



DEC022-1/2MANCH
1/2 conical coupler and M8 screw for
tube of 35

Code : H10332 6,50€^{Incl. VAT}



DEC022Q-EM-B1
Baseplate for DEC022 with connectors

Code : H10225 55€^{Incl. VAT}



Delivered without sleeves
Ref sleeves : DEC022-1/2MANCH
code: H10332

DEC022-EMB2
Rectangular baseplate for Deco arch for
tube of 35. 620 x 240 mm

Code : H10333 85€^{Incl. VAT}



DEC022-EMB3
60x60 baseplate for DEC022T and DEC022Q
- With connectors

Code : H10606 109€^{Incl. VAT}



SST-22
35mm wind up stand adapter for 220
structures.

Code : H10873 23€^{Incl. VAT}



DEC022T TRIANGULAR 220 SILVER



Manufacture according to DIN ISO 4113 and TÜV standards.
Aluminium alloy truss (EN AW 6082 T6)
35 mm in diameter and 1,5 mm thick.

35 mm tubes
8 mm braces
Triangular section with
185 mm spacing between each
tube (220 mm exterior)

Assembly with conical coupler,
spigot pin and Safety R-springs
Section: 220 mm

DEC022T-PT50

Triangular aluminium truss - 20 mm
Length 50 cm

Code : H10229 69€^{Incl. VAT}

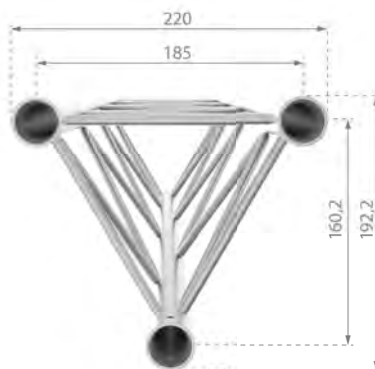
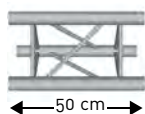

DEC022T-PT100

Triangular aluminium truss - 220 mm
Length 100 cm

Code : H10230 109€^{Incl. VAT}

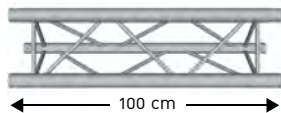

DEC022T-PT200

Triangular aluminium truss - 220 mm
Length 200 cm

Code : H10231 149€^{Incl. VAT}

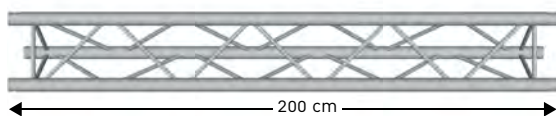

The CONTEST® truss comes with :

- 1 connection kit per bar
- 1 x connection kit, angle - 2 directions
- 2 x connection kits, angle - 3 and 4 directions

LENGTH (M)		2	3	4	5	6
Max centred load (kg)		217,7	143,2	105,4	82,3	66,4
Deformation (mm)		1,9	4,2	7,5	11,9	17,3
Max distributed load (kg/m)		190,2	95,5	52,7	32,9	22,1
Deformation (mm)		2	5,2	9,3	14,6	21,1

The load tables show the weight limits supported between two fixed hook points.
Centred or distributed loads cannot be added together. Consult a qualified technician.

DEC022T TRIANGULAR 220 SILVER

The CONTEST® truss comes with :

- 1 x connection kit, angle – 2 directions
- 2 x connection kits - 3, 4 directions



DEC022T-AG01

Triangular angle 220
2 directions - 50 cm 90°

Code : H10232

99€^{Incl. VAT}



DEC022T-AG02

Triangular angle 220
3 directions - 50 cm 90° - upright

Code : H10233

179€^{Incl. VAT}



DEC022T-AG03

Triangular angle 220
3 directions - 50 cm 90° - left-hand

Code : H10234

179€^{Incl. VAT}



DEC022T-AG04

Triangular angle 220
3 directions - 90° - flat

Code : H10235

135€^{Incl. VAT}

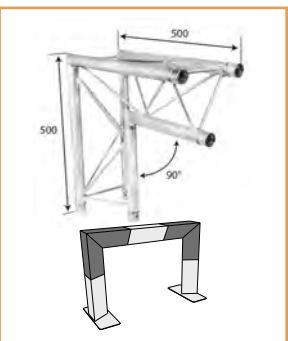

DEC022T-AG05

Triangular angle 220
2 directions - 50 cm 90° - right

Code : H10331

99€^{Incl. VAT}



DEC022T TRIANGULAR 220 SILVER



DEC022T-EM-B1

Trio 220 baseplate with conical couplers, spigot pin and Safety R-springs

Code : H10237 59€^{Incl. VAT}



Delivered without sleeves
Ref sleeves : DEC022-1/2MANCH
code: H10332

DEC022-EMB2

Rectangular baseplate for Deco arch for tube of 35. 620 x 240 mm

Code : H10333 85€^{Incl. VAT}



DEC022-EMB3

60x60 baseplate for DEC022T and DEC022Q - With connectors

Code : H10606 109€^{Incl. VAT}



DEC022T-MC-KIT

Set of 3 conical couplers, 6 spigot pins and 6 Safety R-springs

Code : H10236 39€^{Incl. VAT}



DEC022-MANCH

Conical coupler for Deco series aluminium truss

Code : H10226 5,50€^{Incl. VAT}



DEC022-CLAV

Spigot pin for conical coupler DEC022 series by unit

Code : H10227 3€^{Incl. VAT}



DEC022-GOUP

Safety R-spring for spigot pin

Code : H10228 0,80€^{Incl. VAT}



DEC022-1/2MANCH

1/2 conical coupler and M8 screw for tube of 35

Code : H10332 6,50€^{Incl. VAT}



SST-22

35mm wind up stand adapter for 220 structures.

Code : H10873 23€^{Incl. VAT}



WINCH STANDS



Self-locking gear winch, combined with quality components and workmanship for high stability.

Transport and installation are facilitated by three articulated legs.

Ergonomic clamping wheel to eliminate play in the mast.



ELV-400PRO

Self-braking winch stand with 3 sections
4 metres - 80 kG

Code : H9996

469€^{Incl. VAT}



ELV-270PRO

Self-braking winch stand with 2 sections
2.7 metres - 60 kG

Code : H9995

269€^{Incl. VAT}



Material: Treated steel
Electro-galvanized finish and black epoxy paint
Top mast: Ø 35 mm
Winch: Self-braking anti-return gear
Cable: Galvanized steel, diameter 5 mm
Max height: : 4.00 m
Max load: : 80 kg
Folded length: 1.59 m
Weight: 23 kg
TÜV approved

Material: Treated steel
Electro-galvanized finish and black epoxy paint
Top mast: Ø 35 mm
Winch: Self-braking anti-return gear
Cable: Galvanized steel, diameter 3 mm
Max height: : 2.70 m
Max load: : 60 kg
Folded length: 1.60 m
Weight: 12 kg
TÜV approved



LS-290

Self-braking winch stand - 3.00m / 60 kg

Code : B00747

299€^{Incl. VAT}



LS-270

Economical self-braking 2.70m winch stand

Code : B00738

119€^{Incl. VAT}



SP28-38

28mm spigot adapter for 35mm stand

Code : H11107

18.90€^{Incl. VAT}



Winch stand with automatic brake and lockable safety
Max height: : 3.00 m
Baseplate: 1.20 m
Section of the last mat: 35 mm
Maximum load: 60 kg
Folded length: 1.55 m
Weight: 12 kg
Made in France
TÜV, GS approved

Winch stand with automatic brake and lockable safety
Max height: : 2.70 m
Section of the last mat: 35 mm
Weight: 11 kg
TÜV, GS approved



TOTeL



This totem pole makes it easy to position your speakers or lighting effects. Thanks to the cable passages on the bases, the power, DMX or audio cables disappear for more aesthetics.

Its adjustable height allows it to be adapted to many different situations. The assembly is carried out without tools thanks to 8 clamping wheels which fix the bases to the tubes.

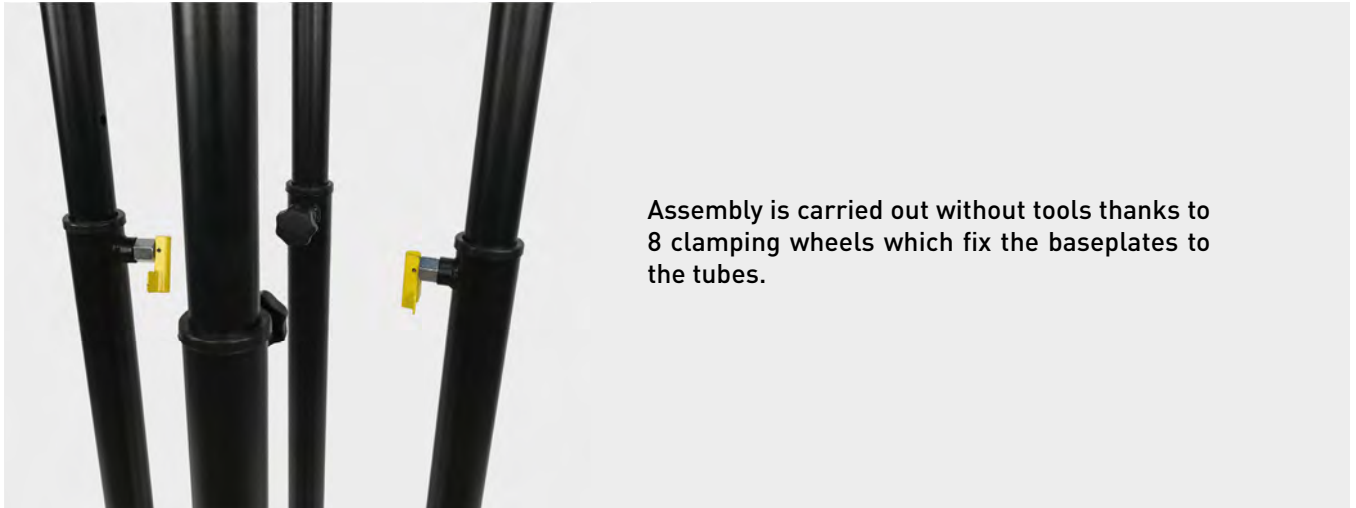

Assembly is carried out without tools thanks to 8 clamping wheels which fix the baseplates to the tubes.

NEW



TOTeL
Telescopic totem from 1 to 1.8m with lycra fabric and covers

Code : H11014 329€^{Incl. VAT}



Minimum height: 1 m
Maximum height: 1.80 m
Lower base: 50 x 50 cm
Upper base: 30 x 35 cm
Diameter of the base tubes: 43 mm
Diameter of telescopic tubes: 35 mm
2 safety pins
2 adjustment wheels
Cable passage 11 x 4 cm
Supplied with 35 mm x 125 mm speaker top mount
Supplied with white Lycra fabric
Comes with a cover for the bases and a cover for the feet
Material: Steel
Finish: Black paint
Weight: 18 Kg
Maximum capacity: 30 Kg



Delivered with baseplate adapter diameter 35 mm x 125 mm

Maximum load: 30kg of inert weight in the vertical axis.

WARNING: Moving objects such as motorized lyre type objects cause swinging movements which can be dangerous. Please check before any use in public.



Delivered with a bag for the baseplates and a bag for the feet.

Bags included for Totel & TotelW



Delivered with baseplate adapter diameter 35 mm x 125 mm

Maximum load: 30kg of inert weight in the vertical axis.

WARNING: Moving objects such as motorized lyre type objects cause swinging movements which can be dangerous. Please check before any use in public.

NEW



TOTelW
White telescopic totem from 1 to 1.8m with lycra fabric and covers

Code : H11130 349€^{Incl. VAT}



Minimum height: 1 m
 Maximum height: 1.80 m
 Lower base: 50 x 50 cm
 Upper base: 30 x 35 cm
 Diameter of the base tubes: 43 mm
 Diameter of telescopic tubes: 35 mm
 2 safety pins
 2 adjustment wheels
 Cable passage 11 x 4 cm
 Supplied with 35 mm x 125 mm speaker top mount
 Supplied with white Lycra fabric
 Comes with a cover for the bases and a cover for the feet
 Material: Steel
 Finish: White paint
 Weight: 18 Kg
 Maximum capacity: 30 Kg

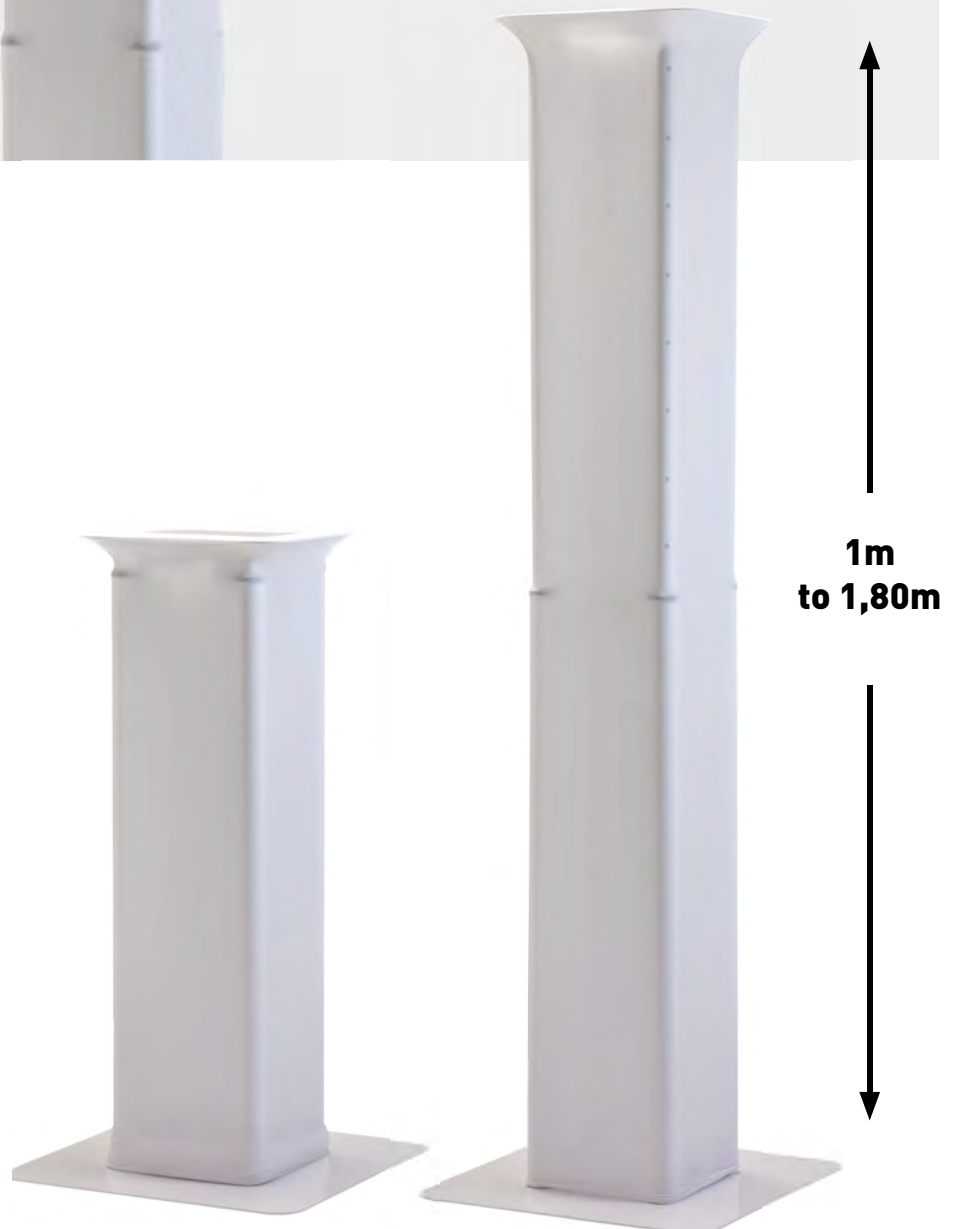

TOTEMS



TOTEM CONTEST® is delivered with:

- 4x Tubes
- 2x Baseplates
- 2x Connection kits
- 1x Spandex textile

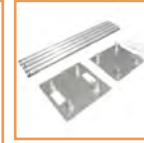
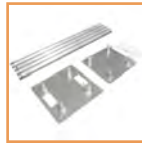

TOT-100

Totem height 100 cm
With baseplates and fabrics

Code : H10243 379€^{Incl. VAT}



TOT-150

Totem height 150 cm
With baseplates and fabrics

Code : H10244 409€^{Incl. VAT}



TOT-200

Totem height 200 cm
With baseplates and fabrics

Code : H10245 439€^{Incl. VAT}



TOT-BASEtop

Upper baseplate for Totem with 4 half-couplers

Code : H10256 89€^{Incl. VAT}



TOT-BASEground

Floor baseplate for Totem with 4 half-couplers

Code : H10255 119€^{Incl. VAT}



TOT-CIRCLE

Circle in tube of 50 of 96 cm diam. for Totem

Code : H10834 209€^{Incl. VAT}



SPANDEX & BAGS



TOT-Spandex1

Elastic fire-resistant textile for 1m Totem

Code : H10257 32€^{Incl. VAT}



TOT-Spandex1.5

Elastic fire-resistant textile for 1.5m Totem

Code : H10258 42€^{Incl. VAT}



TOT-Spandex2

Elastic fire-resistant textile for 2m Totem

Code : H10259 49€^{Incl. VAT}



TOT-Spandex3

Elastic fire-resistant textile for 3m Totem

Code : H11138 99€^{Incl. VAT}



TOT-Spandex4

Elastic textile totem/structure 290 4m white

Code : H11140 119€^{Incl. VAT}



TOT-Spandex1No

Elastic textile for 1m Totem - Black

Code : H10740 32€^{Incl. VAT}



TOT-Spandex1.5No

Elastic textile for 1.5m Totem - Black

Code : H10741 42€^{Incl. VAT}



TOT-Spandex2No

Elastic textile for 2m Totem - Black

Code : H10742 49€^{Incl. VAT}



TOT-Spandex3No

Elastic fire-resistant textile for 3m Totem Black

Code : H11139 99€^{Incl. VAT}



TOT-Spandex4

Elastic textile totem/structure 290 4m - Black

Code : H11141 119€^{Incl. VAT}



TOT-BAGUNO4x100

Carrying case for 4 tubes UNO-100

Code : H11134 24€^{Incl. VAT}



TOT-BAGUNO4x150

Carrying case for 4 tubes UNO-150

Code : H11135 30€^{Incl. VAT}



TOT-BAGUNO4x200

Carrying case for 4 tubes UNO-200

Code : H11136 32€^{Incl. VAT}



TOT-BAGBASES













Bags for Totem Top (Ground & Top)

Code : H11137 26€^{Incl. VAT}



ACCESSORIES

hooks

	CCT-20 Code : H7834 Professional hook for 20 mm tube	4.20€ ^{Incl. VAT}		CCT-50 Code : H3242 Professional hook for tubes from 30 to 50 mm	4.60€ ^{Incl. VAT}		CCT-50B Code : H10414 Pro. hook for 30 to 50 mm tubing-Black	6.50€ ^{Incl. VAT}
	CCT-55 Code : H7835 Hook with counter plate for tubes from 30 to 50mm	6.70€ ^{Incl. VAT}		CCT-55B Code : H10415 Hook + counter plate for tube 30 to 50mm-Black	8.50€ ^{Incl. VAT}		ALU CLAMP035 S Code : H11086 Clamp for 35-40mm tube - 75kg Silver	6.50€ ^{Incl. VAT}
	ALU CLAMP 101-V2 Code : B02687 Alu Clamp SWL 75kg tube 48-51mm TÜV-cert	6.90€ ^{Incl. VAT}		ALU CLAMP101-V2 B Code : H11088 Clamp for tube 50mm 75kg-Black	6.90€ ^{Incl. VAT}		ALU CLAMP 301-V2 Code : B02680 Alu Clamp SWL 300kg TÜV 38-51mm + M10 Silver	11.90€ ^{Incl. VAT}
	ALU CLAMP301-V2 B Code : H11090 Alu Clamp SWL 300kg TÜV 38-51mm + M10 Black	11.90€ ^{Incl. VAT}		ALU CLAMP301-Eye S Code : H11091 38-51 mm 300kg Silver	15.90€ ^{Incl. VAT}		ALU CLAMP 501-V2 Code : B02681 Alu Clamp SWL 500kg TÜV 38-51mm + M10 Silver	16.90€ ^{Incl. VAT}
	ALU CLAMP501-V2 B Code : H11093 Alu Clamp SWL 500kg TÜV 38-51mm + M10 Black	16.90€ ^{Incl. VAT}		SWIVEL CLAMP102 S Code : H11094 Double Tube 38-51mm - 75kg Silver	19.90€ ^{Incl. VAT}		SWIVEL CLAMP102 B Code : H11095 Double Tube 38-51mm - 75kg Black	19.90€ ^{Incl. VAT}
	SWIVEL CLAMP 302-V2 Code : B02682 Swivel clamp SWL 500kg TÜV - 38-51mm Silver	21€ ^{Incl. VAT}		SWIVEL CLAMP302-V2 B Code : H11097 Swivel clamp SWL 500kg TÜV - 38-51mm Black	21€ ^{Incl. VAT}		SWIVEL CLAMP 502-V2 Code : B02683 Swivel clamp SWL 500kg TÜV - 38-51mm Silver	26.90€ ^{Incl. VAT}
	SWIVEL CLAMP502-V2 B Code : H11099 Swivel clamp SWL 500kg TÜV - 38-51mm Black	26.90€ ^{Incl. VAT}		ULTRA CLAMP SILV Code : H11100 Quick hook 48-51 mm - 150kg Silver	19.90€ ^{Incl. VAT}		ULTRA CLAMP black Code : B06600 Quick hook 48-51 mm - 150kg Black	19.90€ ^{Incl. VAT}
	FAST CLAMP silver V2 Code : H11102 Quick hook 38-51 mm - 150kg Silver	14.90€ ^{Incl. VAT}		FAST CLAMP Black V2 Code : B02684 Quick hook 38-51 mm - 150kg Black	14.90€ ^{Incl. VAT}		EASY CLAMP151 Code : H11104 Quick-release hook 44-51mm load 150kg-Si	22.90€ ^{Incl. VAT}
	EASY CLAMP151b Code : H11105 Quick release hook 44-51mm load 150kg-Bl	22.90€ ^{Incl. VAT}						

sleeve & half-sleeve



	MANCH Code : H6523 Single tapered sleeve for PT29 structure	12€ ^{Incl. VAT}		DECO22-MANCH Code : H10226 Conical sleeve for DECO22 truss	5.50€ ^{Incl. VAT}		1/2MANCH Code : H6530 Taper half-sleeve with thread M12 (H=12mm)	9€ ^{Incl. VAT}
	1/2MANCH-M10 Code : H10323 Conical half-sleeve M10 screw for 50" tube	9€ ^{Incl. VAT}		DECO22-1/2MANCH Code : H10332 Conical half-sleeve - M8 thread - for 35mm tubes	6.50€ ^{Incl. VAT}		1/2MANCH-M8 Code : H10636 Half-sleeve for 50mm tube with M8 screw thread	6€ ^{Incl. VAT}
	UNO-1/2MANCH Code : H10254 Extra half-sleeve for UNO-AG01 angle	12€ ^{Incl. VAT}						

pin

	<p>CLAV Code : H6524</p> <p>Pin for Ø 50 mm tube conical sleeve - Sold by the piece</p>	2.30€ ^{incl. VAT}
	<p>DECO22-CLAV Code : H10227</p> <p>Pin for DECO22 conical sleeve Sold by the piece</p>	3€ ^{incl. VAT}

	<p>CLAV/M8 Code : H7840</p> <p>Pin for conical sleeve with M8 screw</p>	3.50€ ^{incl. VAT}
-----------------------------------------------------------------------------------	------------------------------------------------------------------------------------	----------------------------

pin

	<p>Goup Code : H6525</p> <p>Pin for a single wedge</p>	0.50€ ^{incl. VAT}
	<p>DECO22-Goup Code : H10228</p> <p>Safety pin for DECO22 series</p>	0.80€ ^{incl. VAT}

safety cables

	<p>SC10s Code : H11072</p> <p>Safety cable sheathed Ø1,5mm L30cm 1 quick release clip MWL10Kg-Si</p>	2.50€ ^{incl. VAT}
-----------------------------------------------------------------------------------	-----------------------------------------------------------------------------------------------------------------	----------------------------

	<p>SC10b Code : H11073</p> <p>Safety cable sheathed Ø1,5mm L30cm 1 quick release clip MWL10Kg-BL</p>	2.50€ ^{incl. VAT}
-----------------------------------------------------------------------------------	-----------------------------------------------------------------------------------------------------------------	----------------------------

	<p>SC40s Code : H11074</p> <p>Safety cable sheathed Ø2mm L40cm 1 quick release clip MWL40Kg-Si</p>	2.90€ ^{incl. VAT}
------------------------------------------------------------------------------------	---------------------------------------------------------------------------------------------------------------	----------------------------

	<p>SC40b Code : H11075</p> <p>Safety cable sheathed Ø2mm L40cm 1 quick release clip MWL 40Kg-BL</p>	2.90€ ^{incl. VAT}
-----------------------------------------------------------------------------------	----------------------------------------------------------------------------------------------------------------	----------------------------

	<p>SC90s Code : H11076</p> <p>Safety cable sheathed Ø4mm L40cm 1 MWL 90Kg-Si quick fastener</p>	7.90€ ^{incl. VAT}
-----------------------------------------------------------------------------------	------------------------------------------------------------------------------------------------------------	----------------------------

	<p>SC90b Code : H11077</p> <p>Safety cable sheathed Ø4mm L40cm 1 MWL 90Kg-BL quick fastener</p>	7.90€ ^{incl. VAT}
------------------------------------------------------------------------------------	------------------------------------------------------------------------------------------------------------	----------------------------

	<p>SC400s Code : H11078</p> <p>Safety cable sheathed Ø6mm L150cm 2 rings MWL 400Kg-Si</p>	9.90€ ^{incl. VAT}
-----------------------------------------------------------------------------------	------------------------------------------------------------------------------------------------------	----------------------------

	<p>SC700 Code : H11079</p> <p>Safety cable sheathed Ø8mm L150cm 2 rings MWL 700Kg-Si</p>	20.90€ ^{incl. VAT}
-----------------------------------------------------------------------------------	-----------------------------------------------------------------------------------------------------	-----------------------------

	<p>SC1000 Code : H11080</p> <p>Safety cable sheathed Ø10mm L150cm 2 rings MWL 1000Kg-Si</p>	26.90€ ^{incl. VAT}
------------------------------------------------------------------------------------	--------------------------------------------------------------------------------------------------------	-----------------------------

Mounting T

	<p>SST-20 Code : H8262</p> <p>Mounting Tee for Structure 200 on 28mm stand</p>	9€ ^{incl. VAT}
------------------------------------------------------------------------------------	-------------------------------------------------------------------------------------------	-------------------------

	<p>SST-22 Code : H10873</p> <p>Mounting Tee for Structure 220 on 35mm stand</p>	23€ ^{incl. VAT}
------------------------------------------------------------------------------------	--------------------------------------------------------------------------------------------	--------------------------

	<p>SST-35 Code : H3240</p> <p>T for Structure from 150 to 290 on a 35mm stand</p>	62€ ^{incl. VAT}
-------------------------------------------------------------------------------------	----------------------------------------------------------------------------------------------	--------------------------

supports

	<p>SUP-PIL Code : H10608</p> <p>Support for a post with a clamping chain</p>	79€ ^{incl. VAT}
-------------------------------------------------------------------------------------	-----------------------------------------------------------------------------------------	--------------------------

	<p>TCL15 Code : H11106</p> <p>Tent profile hanger bracket load 150kg-Si</p>	32.90€ ^{incl. VAT}
-------------------------------------------------------------------------------------	----------------------------------------------------------------------------------------	-----------------------------

	<p>SPTE290 Code : H10027</p> <p>Suspension piece for 290mm structure</p>	89€ ^{incl. VAT}
--------------------------------------------------------------------------------------	-------------------------------------------------------------------------------------	--------------------------

	<p>OMEGA BRACKET BIG Code : B02678</p> <p>Big version Dimensions (center to center): 141 mm</p>	11.90€ ^{incl. VAT}
-------------------------------------------------------------------------------------	----------------------------------------------------------------------------------------------------------------	-----------------------------

	<p>OMEGA BRACKET SMALL Code : B02677</p> <p>Small version Dimensions (center to center): 106 mm</p>	8.90€ ^{incl. VAT}
-------------------------------------------------------------------------------------	--------------------------------------------------------------------------------------------------------------------	----------------------------

shackle

	<p>SHA1000 Code : H11082</p> <p>Steel shackle MWL 1000Kg</p>	2.50€ ^{incl. VAT}
-------------------------------------------------------------------------------------	-------------------------------------------------------------------------	----------------------------

	<p>SHA1500 Code : H11083</p> <p>Steel Shackle MWL 1500Kg</p>	3.60€ ^{incl. VAT}
-------------------------------------------------------------------------------------	-------------------------------------------------------------------------	----------------------------

	<p>Clip1000 Code : H11081</p> <p>Quick link MWL 1000 kg</p>	1.30€ ^{incl. VAT}
--------------------------------------------------------------------------------------	------------------------------------------------------------------------	----------------------------

wall mount

	<p>SWALL290 Code : H11129</p> <p>Wall mount for 290° structure</p>	249€ ^{incl. VAT}
-------------------------------------------------------------------------------------	-------------------------------------------------------------------------------	---------------------------

	<p>PAT50 Code : H7838</p> <p>Mounting plate for 50 mm tube</p>	33€ ^{incl. VAT}
-------------------------------------------------------------------------------------	---------------------------------------------------------------------------	--------------------------

hanging ring

	<p>EYEM08 Code : H11084</p> <p>Male hanging ring MWL 140kg</p>	0.90€ ^{incl. VAT}
-------------------------------------------------------------------------------------	---------------------------------------------------------------------------	----------------------------

	<p>EYEM10 Code : H11085</p> <p>Male hanging ring MWL 230kg</p>	1.30€ ^{incl. VAT}
-------------------------------------------------------------------------------------	---------------------------------------------------------------------------	----------------------------

	<p>EYE-10F Code : H10436</p> <p>Female M10 eye bolt MWL230kg</p>	3.30€ ^{incl. VAT}
--------------------------------------------------------------------------------------	-----------------------------------------------------------------------------	----------------------------



PLATFORMS PLTEL

LIGHTWEIGHT PLATFORM WITH TELESCOPIC LEGS



FIRE RESISTANCE

Fire resistance class: **Bfl-S1** (corresponds to the French class **M1**). It conforms to the **EN13501-1+A1:2010** European standard.

NEW



PLTEL-1x1

Platform 1x1 m with folding and telescopic legs

Code : H11108

449€^{incl. VAT}

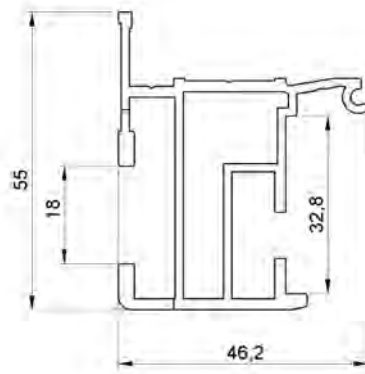

Material:
Frame : Aluminium
Tray : 12mm anti-slip plywood
Dimension 1 x 1 m
Thickness : 55 mm
Telescopic legs from 40 to 60 cm high
Permissible distributed load : 300 Kg/m².
Finish : Aluminium / Black
Weight : 18 Kg

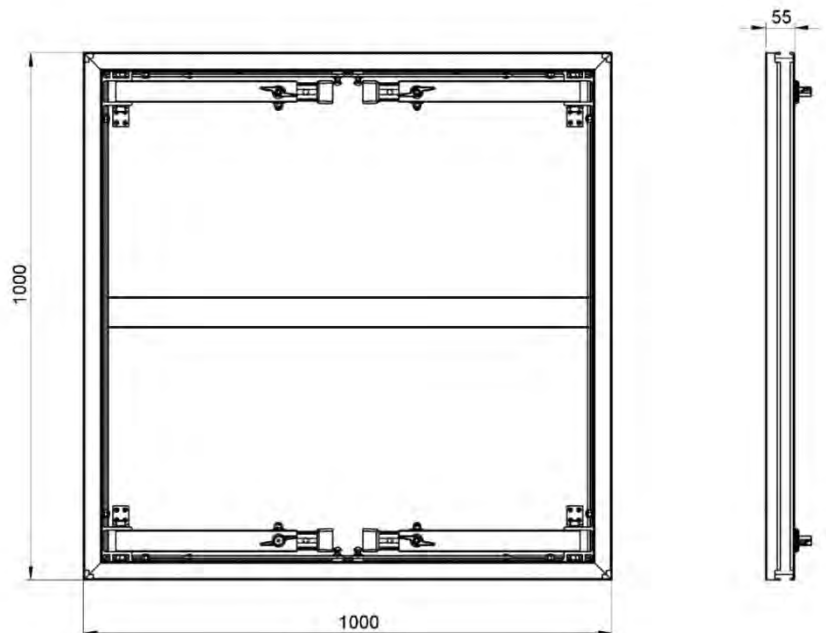



PLTEL-h1X1

Handrail for PLTEL platform 1m without fixation

Code : H11110 159€^{Incl. VAT}



PLTEL-ha

Corner handrail for PLTEL platform 1m without fixation

Code : H11111 159€^{Incl. VAT}



PLTEL-hc1

Attachment of guardrail to tray for PLTEL

Code : H11109 13€^{Incl. VAT}



PLTS-c1

Platform assembly clamp

Code : H10371 9€^{Incl. VAT}



Material: Steel
Thickness: 4 mm
Weight: 0.42 Kg



PLT-j1

Junction insert

Code : H10372 9€^{Incl. VAT}



PLT-j2

Leveling insert

Code : H10373 3.50€^{Incl. VAT}



Compatible with PLTL and PLTS series
Material: Steel
Thickness: 3 mm
Weight: 78 g

Compatible with PLTL and PLTS series
Material: ABS
Weight: 11 g



PLATFORMS PLTS

PLATFORMS FOR THE STAGE



FIRE RESISTANCE

Fire resistance class: **Bfl-S1** (corresponds to the French class **M1**). It conforms to the **EN13501-1+A1:2010** European standard.

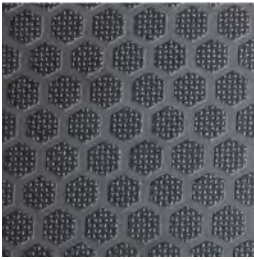

12mm black multi-ply anti-slip plywood

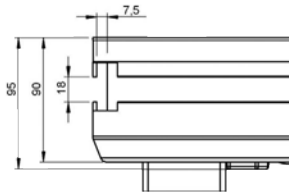

Internal structure of the multi-ply plywood platform and aluminium frame (EN AW6082T6)



NEW PLATFORMS NEW UNIVERSAL ANGLES



ROUND LEGS
48.3mm

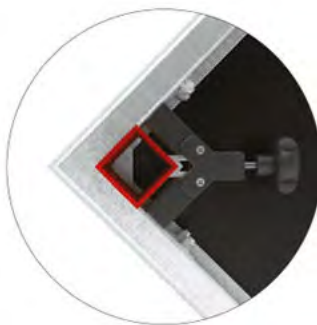

SQUARE LEGS
50X50mm

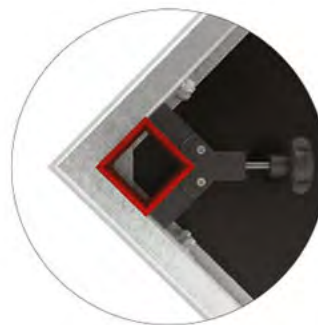

SQUARE LEGS
60X60 mm

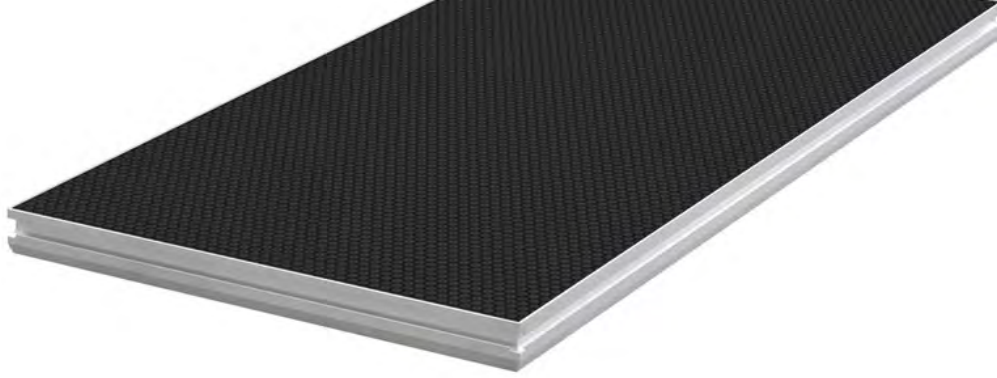

PLTS-1x1

1m Platform x 1m non-slip 750 kg/m²- black - Delivered without legs

Code : H10370

309€^{Incl. VAT}



Material:
 - Frame: Aluminium
 - Tray: 12mm multi-ply
 Thickness: 90 mm
 Allowable distributed load: 750 Kg/m²
 Weight: 16 Kg



PLTS-2x1

2m Platform x 1m non-slip 750 kg/m²- black - Delivered without legs

Code : H10369

359€^{Incl. VAT}



Material:
 - Frame: Aluminium
 - Tray: 12mm multi-ply
 Thickness: 90 mm
 Allowable distributed load: 750 Kg/m²
 Weight: 32 Kg



PLTS-1x0.5

Platform 1x0.5m non-slip 750 kg/m²- black - Delivered without legs

Code : H10602

189€^{Incl. VAT}



Material:
 - Frame: Aluminium
 - Tray: 12mm multi-ply
 Thickness: 90 mm
 Allowable distributed load: 750 Kg/m²
 Weight: 8 Kg



PLTS-2x0.5

Platform 2x0.5m non-slip 750 kg/m²- black - Delivered without legs

Code : H10601

299€^{Incl. VAT}



Material:
 - Frame: Aluminium
 - Tray: 12mm multi-ply
 Dimension : 2 m x 0.5 m
 Thickness: 90 mm
 Allowable distributed load: 750 Kg/m²
 Weight: 16 Kg



PLTS-T1x1

1x1m anti-slip triangular platform 750 kg/m²- black - Delivered without legs

Code : H10603

409€^{Incl. VAT}



Material:
 - Frame: Aluminium
 - Tray: 12mm multi-ply
 Dimension : 1 x 1 m
 Thickness: 90 mm
 Allowable distributed load: 750 Kg/m²
 Weight: 8 Kg



PLTS-c1

Platform assembly clamp

Code : H10371

9€^{Incl. VAT}



Material: Steel
 Thickness: 4 mm
 Weight: 0.42 Kg



PLT-j1

Junction insert

Code : H10372

9€^{Incl. VAT}



Compatible with PLTL and PLTS series
 Material: Steel
 Thickness: 3 mm
 Weight: 78 g



PLT-j2

Leveling insert

Code : H10373

3.50€^{Incl. VAT}



Compatible with PLTL and PLTS series
 Material: ABS
 Weight: 11 g



PLATFORMS PLTS



PLTS-ft4060

Telescopic square leg - 0.4 m to 0.6m - per unit

Code : H10374 36€^{Incl. VAT}



Material: Aluminium
Thickness: 2 mm
Section: 60 x 60 mm
Weight: 1.66 Kg



PLTS-ft60100

Telescopic square leg - 0.6m to 1m - per unit

Code : H10375 45€^{Incl. VAT}



Material: Aluminium
Thickness: 2 mm
Section: 60 x 60 mm
Weight: 1.8 Kg



PLTS-ft80140

Telescopic square leg - 0.8m to 1.4m - per unit

Code : H10403 52€^{Incl. VAT}



Material: Aluminium
Thickness: 2 mm
Section: 60 x 60 mm
Weight: 2.5 Kg



PLTS-f20

Square leg 20 cm high - per unit

Code : H10376 8.50€^{Incl. VAT}



Material: Aluminium
Thickness: 2 mm
Section: 60 x 60 mm
Weight: 0.42 Kg



PLTS-f40

Square leg 40 cm high - per unit

Code : H10377 12€^{Incl. VAT}



Material: Aluminium
Thickness: 2 mm
Section: 60 x 60 mm
Weight: 0.78 Kg



PLTS-f60

Square leg 60 cm high - per unit

Code : H10378 16€^{Incl. VAT}



Material: Aluminium
Thickness: 2 mm
Section: 60 x 60 mm
Weight: 1.15 Kg



PLTS-f80

Square leg 80 cm high - per unit

Code : H10379 19€^{Incl. VAT}



Material: Aluminium
Thickness: 2 mm
Section: 60 x 60 mm
Weight: 1.52 Kg



PLTS-f100

Square leg 1 m high - per unit

Code : H10380 22€^{Incl. VAT}



Material: Aluminium
Thickness: 2 mm
Section: 60 x 60 mm
Weight: 1.89 Kg



PLTS-FW24

Square leg with caster - Height 24,5 cm

Code : H10858 36€^{Incl. VAT}



Material: Aluminium
Thickness: 3 mm
Section: 60 x 60 mm
Wheel diameter: 100 mm
Weight: 1.41 Kg



PLTS-FW40

Square leg with caster - Height 40 cm

Code : H10859 42€^{Incl. VAT}



Material: Aluminium
Thickness: 3 mm
Section: 60 x 60 mm
Wheel diameter: 100 mm
Weight: 1.69 Kg



PLTS-FW60

Square leg with caster - Height 60 cm

Code : H10860 46€^{Incl. VAT}



Material: Aluminium
Thickness: 3 mm
Section: 60 x 60 mm
Wheel diameter: 100 mm
Weight: 2.06 Kg



PLTS-FW80

Square leg with caster - Height 80 cm

Code : H10861 52€^{Incl. VAT}



Material: Aluminium
Thickness: 3 mm
Section: 60 x 60 mm
Wheel diameter: 100 mm
Weight: 2.43 Kg



PLTS-FW100

Square leg with caster - Height 100 cm

Code : H10862 55€^{Incl. VAT}



Material: Aluminium
Thickness: 3 mm
Section: 60 x 60 mm
Wheel diameter: 100 mm
Weight: 2.80 Kg



PLTS-fc2

Connecting clamp for two square legs

Code : H10381 11€^{Incl. VAT}



Material: Aluminium
Thickness: 5 mm
For section: 60 x 60 mm
Weight: 0.48 Kg



PLTS-fc4

Connecting clamp for four square legs

Code : H10382 25€^{Incl. VAT}



Material: Aluminium/Steel
Thickness: 4,5 mm
For section: 60 x 60 mm
Weight: 0.48 Kg



PLATFORMS PLTS



BT-STAGE-LEGADJ-45/60CM

Telescopic round leg – 0.45m to 0.60m

Code : B03712 45€^{Incl. VAT}



Material: Aluminium
Thickness: 3 mm
diameter: 48 mm
Weight: 1.78 Kg



BT-STAGE-LEGADJ-60/90 CM

Telescopic round leg – 0.60m to 0.90m

Code : B03713 55€^{Incl. VAT}



Material: Aluminium
Thickness: 3 mm
diameter: 48 mm
Weight: 2.37 Kg



BT-STAGE-LEGFIX-20CM

Round leg, fixed height = 20cm, +/- 5cm adj.

Code : B03716 16€^{Incl. VAT}



Material: Aluminium
Adjustable leg: up to 5 cm
Thickness: 3 mm
diameter: 48 mm
Weight: 0.30 Kg



BT-STAGE-LEGFIX-40CM

Round leg, fixed height = 40cm, +/- 5cm adj.

Code : B03710 21€^{Incl. VAT}



Material: Aluminium
Adjustable leg: up to 5 cm
Thickness: 3 mm
diameter: 48 mm
Weight: 0.49 Kg



BT-STAGE-LEGFIX-60CM

Round leg, fixed height = 60cm, +/- 5cm adj.

Code : B03711 24€^{Incl. VAT}



Material: Aluminium
Adjustable leg: up to 5 cm
Thickness: 3 mm
diameter: 48 mm
Weight: 0.72 Kg



BT-STAGE-LEGFIX-80CM

Round leg, fixed height = 80cm, +/- 5cm adj.

Code : B03714 27€^{Incl. VAT}



Material: Aluminium
Adjustable leg: up to 5 cm
Thickness: 3 mm
diameter: 48 mm
Weight: 0.82 Kg



BT-STAGE-LEGFIX-100CM

Round leg, fixed height = 100cm, +/- 5cm adj.

Code : B03715 32€^{Incl. VAT}



Material: Aluminium
Adjustable leg: up to 5 cm
Thickness: 3 mm
diameter: 48 mm
Weight: 1.18 Kg



BT-STAGE-LEGCLAMP-4

Connecting clamp for four round legs

Code : B03723 25€^{Incl. VAT}



Material: Steel
Thickness: 5 mm
Weight: 1.6 Kg



BT-STAGE-LEGCLAMP-2

Connecting clamp for two round legs

Code : B03722 11€^{Incl. VAT}



Material: Steel
Thickness: 5 mm
Weight: 0.9 Kg



PLTS-g1x1

Bar railing lg 1 m without fastener

Code : H10421 199€^{Incl. VAT}



Material: Aluminium
Diameter: 45.2 mm
Weight: 7.9 Kg
Length: 1 m
Height: 1.2 m

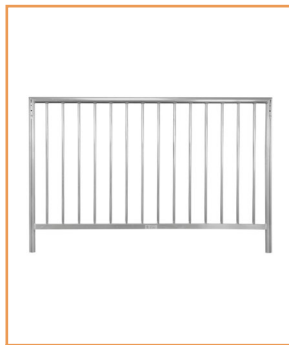

PLTS-g2x1

Bar railing lg 2 m without fastener

Code : H10422 289€^{Incl. VAT}



Material: Aluminium
Diameter: 45.2 mm
Weight: 12 Kg
Length: 2 m
Height: 1.2 m



PLTS-gc1

Straight fastener for bar railing

Code : H10454 119€^{Incl. VAT}



Straight fastener for guardrail:
PLTS-g2x1
PLTS-g1x1



PLTS-gc2

Angled fastener for bar railing

Code : H10455 119€^{Incl. VAT}



Angled fastener for guardrail:
PLTS-g2x1
PLTS-g1x1

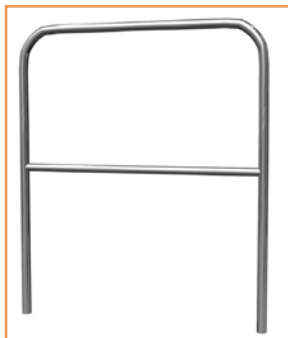

PLTS-h1x1

Guardrail for platform of 1m length
Supplied with fasteners

Code : H10392 149€^{Incl. VAT}



Material: Aluminium
Thickness: 2 mm
Diameter: 35 mm
Weight: 2.83 Kg
Length: 1 m
Height: 1.2 m

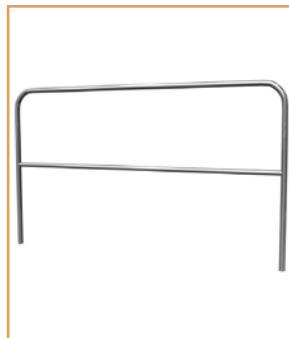

PLTS-h2x1

Guardrail for platform of 2m length
Supplied with fasteners

Code : H10391 159€^{Incl. VAT}



Material: Steel
Thickness: 4 mm
Weight: 0.45 Kg



PLTS-hc1

Platform guardrail fastener - per unit

Code : H10393 32€^{Incl. VAT}



Guardrail fastener:
PLTS-h1x1
PLTS-h2x1
Material: Steel
Thickness: 4 mm
Weight: 0.45 Kg



PLTS-hc2

STAGE series guardrail junction clamp

Code : H10394 11€^{Incl. VAT}



Junction clamp for guardrail
PLTS-h1x1
PLTS-h2x1
Material: Steel
Thickness: 5.5 mm
Weight: 1.14 Kg

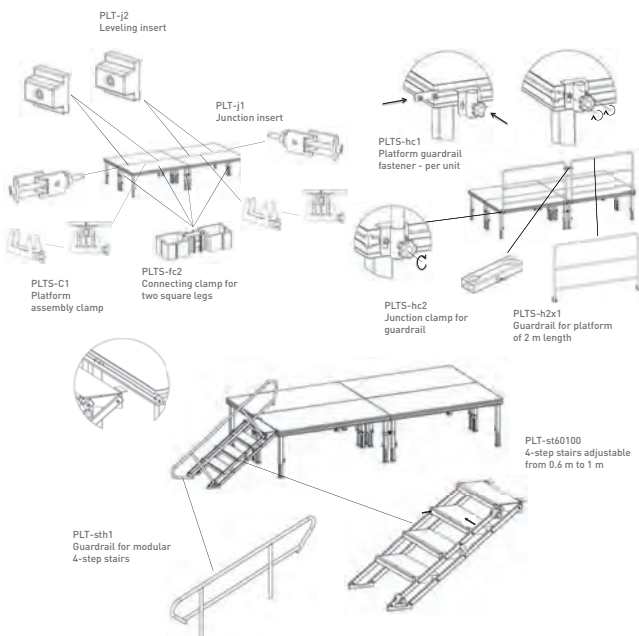

ATTENTION ON THE SOIL CAPACITY

Soft ground can affect the safety of the installation. Please spread the loads evenly across the platform surface.

ABOUT THE GUARDRAIL & STAIRS

A guardrail must be installed when the height is greater than 50 cm. Stairs less than or equal to 120 cm wide must have at least one handrail.

CAUTION IN ACCORDANCE WITH THE NF E85-015 STANDARD

A maximum height of 150 cm is allowed. A guardrail must be installed if the height to be climbed is greater than 50 cm.

These provisions are not exhaustive. For other prescriptions, obtain the standard quoted above.



PLATFORMS PLTL

LIGHT PLATFORM WITH FOLDABLE FEET



PLTL-1x1

Mobile platform 1m x 1m - 500 kg/m² - black Delivered without legs

Code : H10395

199€^{Incl. VAT}



Material: Aluminium/multi-ply 12mm
Dimensions 1 x 1 m
Thickness: 55 mm
Allowable distributed load: 500 Kg/m²
Finish: Black
Weight: 12.10 Kg



Fire resistance

Fire resistance class Bfl-S1
It complies with European standard
EN13501-1 + A1: 2010



Attention

The maximum height allowed is 1 meter with 2 supports stacked.

About Handrails & stairs

A handrail must be installed as soon as the drop height is more than 50cm.

A stair lower or equal to 120 cm must have at least one handrailà 50 cm.

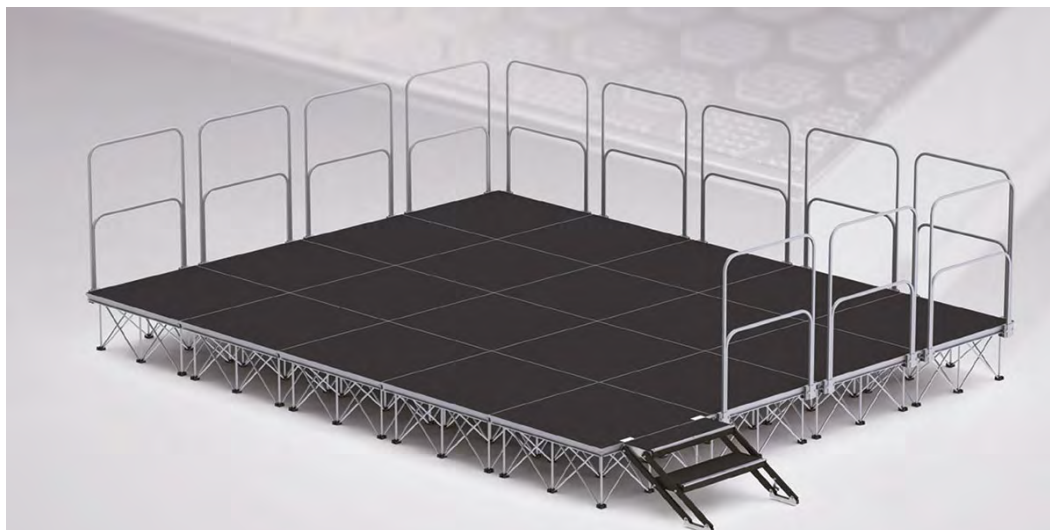

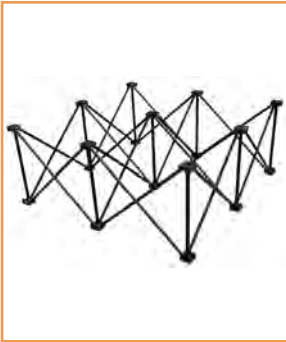

PLTL-f20

Support for mobile platform 1 x 1m - height 20cm

Code : H10396 89€^{Incl. VAT}



Material: Aluminium + ABS
 Finish: Black
 Operating height: 20 cm
 Folded height: 46.4 cm
 Weight: 2.6 Kg

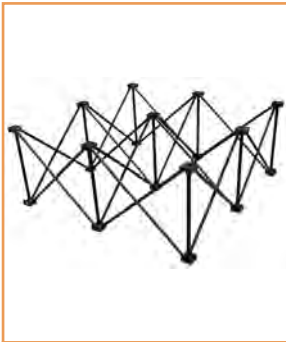

PLTL-f40

Support for mobile platform 1 x 1m - height 40cm

Code : H10397 99€^{Incl. VAT}



Material: Aluminium + ABS
 Finish: Black
 Operating height: 40 cm
 Folded height: 57.4 cm
 Weight: 3.5 Kg

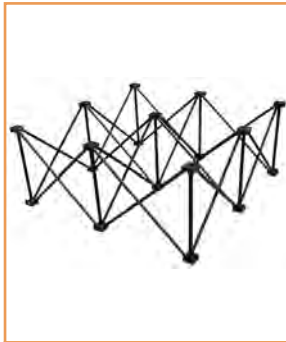

PLTL-f60

Support for mobile platform 1x1m - height 60cm

Code : H10398 119€^{Incl. VAT}



Material: Aluminium + ABS
 Finish: Black
 Operating height: 60 cm
 Folded height: 72.6 cm
 Weight: 4.5 Kg



PLTL-Con

Code : H10605 1€^{Incl. VAT}



PLTL series platform support junction connector (to be combined with PLTL-CLIP)



PLTL-Clip

Code : H10604 4€^{Incl. VAT}



PLTL series platform support clip (to be combined with PLTL-CON)

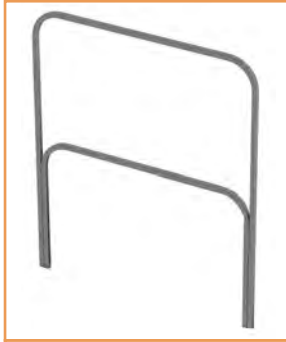

PLTL-h1x1

Guardrail for platform - length 1 m

Code : H10399 79€^{Incl. VAT}



Material: Steel
 Finish: Black
 Section: 25 x 25 mm
 Weight: 4.46 Kg



PLTL-hc1

Guardrail fastener for mobile platform - per unit

Code : H10400 20€^{Incl. VAT}



Material: Steel
 Finish: Grey
 Weight: 0.45 Kg



PLT-j1

Junction insert

Code : H10372 9€^{Incl. VAT}



Compatible with PLTL and PLTS series
 Material: Steel
 Thickness: 3 mm
 Weight: 78 g



PLT-j2

Leveling insert

Code : H10373 3.50€^{Incl. VAT}



Compatible with PLTL and PLTS series
 Material: ABS
 Weight: 11 g





PLT-st4060

Stairs adjustable from 0.4 m to 0.6 m - 2 steps

Code : H10383

469€^{Incl. VAT}



Frames: Steel
Finish: Black
Step: 12mm multi-ply
Weight: 16.2 Kg



PLT-st60100

Stairs adjustable from 0.6 m to 1 m - 4 steps

Code : H10384

529€^{Incl. VAT}



Frames: Steel
Step: 12mm multi-ply
Finish: Black
Weight: 30 Kg



PLT-st80140

Stairs adjustable from 0.8m to 1.4m - 5 steps

Code : H10404

599€^{Incl. VAT}



Frames: Steel
Step: 12mm multi-ply
Finish: Black
Weight: 37.46 Kg



PLT-sth1

Guardrail for adjustable stairs

Code : H10385

139€^{Incl. VAT}



Material: Aluminium
Thickness: 2 mm
Diameter: 35 mm
Weight: 3.79 Kg
Length: 2.3 m
Height: 0.76 m



PLT-stm20

Modular 1-step stairs - height 20 cm

Code : H10386

169€^{Incl. VAT}



Frames: Steel
Step: 12mm multi-ply
Finish: Black
Weight: 9.61 Kg



PLT-stm40

Modular 2-step stairs - heights 20 and 40 cm

Code : H10387

249€^{Incl. VAT}



Frames: Steel
Steps: 12mm multi-ply
Finish: Black
Weight: 20.61 Kg



PLT-stm60

Modular 1-step stairs - height 60 cm

Code : H10388

159€^{Incl. VAT}



Frames: Steel
Step: 12mm multi-ply
Finish: Black
Weight: 12.15 Kg



PLT-stm80

Modular 1-step stairs - height 80 cm

Code : H10389

169€^{Incl. VAT}



Frames: Steel
Step: 12mm multi-ply
Finish: Black
Weight: 13.46 Kg



PLT-sth2

Guardrail for modular stairs - length 140cm

Code : H10390

159€^{Incl. VAT}



Material: Aluminium
Thickness: 2 mm
Diameter: 35 mm
Weight: 3.4 Kg



PLT-TROLL

Platform transport trolley

Code : H10424

489€^{Incl. VAT}



Transport trolley for 2x1 platforms



PLT-BOARD

Platform transport trays

Code : H10423

249€^{Incl. VAT}



2 transport trays
4 braked castors per tray delivered without strap



FLY6PLTL1

Flight case for 6 PLTL-1x1 with legs

Code : H10430

629€^{Incl. VAT}



Flight case on wheels for transporting 6 PLTL-1x1 platforms, 6 legs and accessories

	<p>PLTL-JU20x100 Code : H10469</p> <p>Skirt for PLTL platform H20cm W105cm</p>	<p>16€^{Incl. VAT}</p> 

	<p>PLTL-JU20x200 Code : H10474</p> <p>Skirt for PLTL platform H20cm W205cm</p>	<p>30€^{Incl. VAT}</p> 

	<p>PLTL-JU40x100 Code : H10470</p> <p>Skirt for PLTL platform H40cm L105cm</p>	<p>18€^{Incl. VAT}</p> 

	<p>PLTL-JU40x200 Code : H10475</p> <p>Skirt for PLTL platform H40cm L205cm</p>	<p>36€^{Incl. VAT}</p> 

	<p>PLTL-JU60x100 Code : H10471</p> <p>Skirt for PLTL platform H60cm L105cm</p>	<p>19€^{Incl. VAT}</p> 

	<p>PLTL-JU60x200 Code : H10476</p> <p>Skirt for PLTL platform H60cm L205cm</p>	<p>39€^{Incl. VAT}</p> 

	<p>PLTL-JU60x600 Code : H11116</p> <p>Skirt 60cm high - 6m long</p>	<p>159€^{Incl. VAT}</p> 

	<p>PLTL-JU80x100 Code : H10472</p> <p>Skirt for PLTL platform H80cm L105cm</p>	<p>24€^{Incl. VAT}</p> 



	<p>PLTL-JU80x200 Code : H10477</p> <p>Skirt for PLTL platform H80cm L205cm</p>	<p>48€^{Incl. VAT}</p> 



	<p>PLTL-JU80x600 Code : H11115</p> <p>Skirt 80cm high - 6m long</p>	<p>189€^{Incl. VAT}</p> 

	<p>PLTL-JU100x100 Code : H10473</p> <p>Skirt for PLTL platform H100cm L105cm</p>	<p>29€^{Incl. VAT}</p> 

	<p>PLTL-JU100x200 Code : H10478</p> <p>Skirt for PLTL platform H100cm W205cm</p>	<p>59€^{Incl. VAT}</p> 

	<p>PLTL-JU100x600 Code : H11114</p> <p>Skirt 1m high - 6m long</p>	<p>219€^{Incl. VAT}</p> 

	<p>PLTL-JUSUP Code : H10479</p> <p>Fastening profile for skirts PLTL-JU L105cm</p>	<p>15€^{Incl. VAT}</p> 

	<p>PLTL-JUVEL6M Code : H11117</p> <p>Adhesive Velcro attachment roll length 6m</p>	<p>45€^{Incl. VAT}</p> 



 **Hilec**

LIGHT & SOUND ACCESSORIES

PROFESSIONAL SERIES



High Quality Pro Cable



ACCESSORIES

LIGHTING STANDS AND LIGHT
SPEAKER STANDS
MICROPHONE STANDS
MICROPHONE ACCESSORIES
SUPPORTS
WALL BRACKETS
PROTECTIVE COVERS
BATTERIES
GAFFAS
COLOURING
GOOSENECK LIGHTS
SOUND CABLES LINE
SOUND CABLES SPEAKERS
SOUND CABLES MICRO-
PHONES
NEUTRIK® SOUND CABLES
HYBRID SOUND CABLES
DMX LIGHT CABLES
HYBRID LIGHT CABLES
CABLES POWER SUPPLY
SOUND CABLE
VIDEO CABLES
LIGHT CABLE
ELECTRIC CABLE

CAT6 CABLE
NEUTRIK® CONNECTORS
ELECTRICAL CONNECTORS
ADAPTERS
ADAPTER DANTE/ANALOGIQUE
CONSTRUCTION
SPEAKERS AND FILTERS
LAMPS



STANDS AND LIGHT BRIDGES



POT-330

Light bridge with steel structure
Length: 3.00 m Height: 3.20 m

Code : H8259



Net weight: 21.6 Kg
Light bridge height: 1.49 to 3,18 m
Light bridge width:
3 m (2x 1.5 m trusses)
Number of holes: 10
Supported load: 80 Kg distributed
Dimension of each stand on the ground:
1.2 m
Diameter of the stand tubes: 28 mm
Materials:
- Steel
- ABS for the wheels
Finish: black epoxy paint

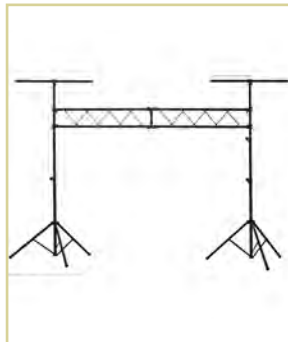

LB-30

Light bridge: 2stand+truss,
H3.25m - B4.2m -100kg

Code : B00755



Multifunctional aluminium economical bridge
Consisting of 2 stands with T-bar and 2 bridge elements
The 2 stands with T-bar can be used separately!
Perfect for the mobile DJ
Distributed load up to 100kg!
Distance between the stands = 3m
Total width with installed T-bars = 4.2m
Maximum height = 3.25m



PID-100

Robust double crossbar stand, all-metal
Height 3 m ø28

Code : H8252



Net weight: 5.3 Kg
Height: from 1.48 to 3.13m
Folded height: 1.23 m
Tripod diameter: 1.4 m
Supported load: 30 Kg
Final tube diameter: 28 mm
Tripod with double crossbars
Materials:
- Steel for tubes, tripod and crossbars
- Rubber for the ends of the tubes
- ABS for the knobs
Finish: matte black epoxy paint



PID-240

Stand + all-metal bar Height 2.40 m ø28

Code : H8253



Net weight: 6.7 Kg
Height: from 1.49 to 2.40 m
Folded height: 1.23 m
Tripod diameter: 1.2 m
Supported load: 30 Kg
Diameter of the final tube: 28 mm
Horizontal bar length: 1 m
Single crossbar tripod
Materials:
- Steel for tubes, tripod and cross
- Rubber for the ends of tubes
- ABS for the knobs
Finish: matte black epoxy paint



LST-32

Light stand + T-bar, extendable - H3.18m/
B1.5m/30kg

Code : B00756



Very stable folding lighting bracket with 100cm T-bar
Robust design with 3 telescopic steel sections.
Perfect for mounting all kinds of projectors and small lighting effects
Maximum load: 30kg
Net weight: 6.53 Kg
Max. height: 3.18 m



PID-380

3m stand with bar and maximum load of 80 kg

Code : H10489



Net weight: 11.2 Kg
Height: from 1.87 to 3 m
Folded height: 1.59 m
Tripod diameter: 1.3 m
Supported load: 80 Kg
Diameter of the final tube: 35 mm
Length of the horizontal bar: 1.5 m
Horizontal bar diameter: 35 mm
Tripod with double crossbars
Materials:
- Steel for tubes, tripod and crossbars
- Rubber for the ends of tubes
- ABS for the knobs
Finish: matte black epoxy paint



LS-64
Lighting stand – 3.10m / 80kg

Code : B00732



FLOOR4
Projector floor stand with M10 screw

Code : H9666



PROJECTOR FLOOR STAND
Projector floor stand with M10 screw

Code : B04947



SP28-38
28mm spigot adapter for 35mm stand

Code : H11107



Multifunctional professional stand can be used as speaker stand or lighting stand
Can be used as lighting stand with the TB-66 bar, available as an option.
Max. load: 80kg



PID1-BAG
Code : H10012 Customized for PID-100 and PID-240 stands
Maximum diameter: 16 cm
Maximum height: 125 cm



PID2-BAG
Code : H10013 Customized for PID-100 and PID-240 stand
Maximum diameter: 20 cm
Maximum height: 125 cm



BRE-120
Code : H8256 Internal diameter of the stand adaptor: 28 mm
Bar length: 1.20 m
Bar section: 30 x 30 mm
Number of holes: 4
Materials: Steel and ABS for the knob
Finish: matte black epoxy paint
Net weight: 1.6 Kg



BRE-50
Code : H8845 Length: 1.5 m / round section: 50 mm
Stand adaptor for 35 mm stands
Weight: 3.6 kg



TB-66
Code : B00733 T-Bar for LS-64
Mounting of up to 12 projectors
Equipped with fixing hardware
Length = 150cm
Designed for mounting on standard 35mm mast top



TB-64
Code : B00743 Steel T-Bar (30x30mm)
Mounting up to 8 projectors
Equipped with fixing hardware
Length = 120cm
Planned for mounting on standard 35mm mast top



T 150
Code : B02616 Truss adaptor for 150mm truss
Suitable for all our stands that have a ø35mm mast top



DJ-TRUSS 200
Code : B00739 Very strong and compact steel truss, section 150
Length = 2m



DJ-TRUSS 150
Code : B00740 Very strong and compact steel truss, section 150
Length = 1.5m



SST-20
Code : H8262 For PT20-150 truss only
Bar length: 21 cm
Section of the bar: 30 x 20 mm
Internal diameter of the stand adaptor: 28 mm
M8 screw for fastening the truss
Finish: matte black epoxy paint
Weight: 0.40 Kg



SST-22
Code : H10873 Stand adaptor with 35mm tube for 220 truss



SPEAKER STANDS



SS-AIR

Speaker stand, expandable pneumatic brake - 1.80m / 60kg

Code : B00734



Professional aluminium speaker stand, equipped with a special air cushion system!
To avoid any accident, the speaker goes down slowly instead of "falling" on its base
Very stable construction with metal base
Low minimum height: facilitates placement of the speaker on the stand!
Max load: 60kg



CAB-200

All-metal speaker stand Height 2 m

Code : H8245



Net weight: 4.5 Kg
Height: from 1.41 to 2.10 m
Folded height: 1.08 m
Tripod diameter: 1.2 m
Supported load: 40Kg
Diameter of the final tube: 35 mm
Tripod with single crossbars
Materials:
Steel for tubes and tripod
Rubber for the ends of tubes
ABS for the knobs
Finish: matte black epoxy paint



SS-59

Speaker stand, extendable - 2.05m / 40kg

Code : B00737



Professional speaker stand
Very stable construction with metal base
Low minimum height: facilitates placement of the speaker on the stand
Max load: 40kg



TUB-LINK

83 to 123cm telescopic pole with pin

Code : H9105



Telescopic pole
Diameter of the upper part: 35mm
Diameter of the lower part: 35mm
Height: 83 cm to 123 cm
Load capacity: 30kg



SPEAKER POLE (M20 thread)

Telescopic pole

Code : B00659



Telescopic pole
Diameter of the upper part: 35mm
Bottom thread: 20mm
Height: 76 cm to 1.16 m
Load capacity: 30kg



VP-130

Telescopic pole

Code : B00655



This special stand offers you the possibility to place a speaker from 0.7m to 1.3m

SPEAKER STANDS



TWIN SPEAKER BRACKET Mk2

Adapter for 2 speakers on one stand

Code : B00763



Adapter for installing 2 speakers on a single stand.
The distance between the speakers can be adjusted between 32 and 51cm.
Solid steel construction.
For speakers up to 2x 20kg
Adapter diameter: D=35mm



FORK

Separate 42 cm double 35mm adapter for speakers up to 40Kg

Code : H7916



Adapter for the installation of 2 speakers on a single stand.
Distance between speakers: 42cm.
Solid steel construction.
For speakers up to 40 Kg
Diameter of the adapter: D=35mm



CAB1-BAG

Bag for 1 speaker stand

Code : H10010



Customized for Audiophony CAB-100 and CAB-200 stands
Adjustable strap
Maximum diameter: 16 cm
Maximum height: 110 cm



CAB2-BAG

Bag for 2 speaker stands

Code : H10011



Customized for Audiophony CAB-100 and CAB-200 stands
Divider
Adjustable strap
Maximum diameter: 20 cm
Maximum height: 110 cm



BAG-STAND

Nylon bag for stands intended for lighting effects or sound system elements

Code : B00741



Stylish and durable nylon bag for stands intended for lighting effects or sound system elements
Perfect for SS-59, SS-AIR, LST-32 stands



MICROPHONE STANDS



MIC-200T

Microphone stand with telescopic boom with heavy baseplate - adjustable height

Code : H8236



Microphone stand with telescopic boom with heavy baseplate
 Net weight: 5.3 Kg
 Height: from 92 cm to 1.52 m
 Baseplate diameter: 25.5 cm
 Thread at the boom tip: 3/8"
 Boom length: 55 to 90 cm
 Materials:
 - Aluminium for the boom hinge
 - Steel for the tubes and baseplate
 - Rubber for the ends of tubes
 - ABS for the knobs and the boom tip
 Finish: matte black epoxy paint



MIC-100

All-metal microphone boom tripod with adjustable height

Code : H8235



Net weight: 2.9 Kg
 Height: from 1.05 to 1.60 m
 Tripod diameter: 72 cm
 Thread at the end of the pole: 3/8"
 Boom length: 74 cm
 Materials:
 - Aluminium for the tripod and boom hinge
 - Steel for the tubes
 - Rubber for the ends of tubes
 - ABS for the knobs and the pole tip
 Finish: matte black epoxy paint



MS-26PRO

Adjustable height all-metal pole tripod

Code : B00765



Professional microphone stand with adjustable boom
 Robust and resistant magnesium base
 Very good stability
 Boom length: 64cm
 Thread at the end of the pole: 3/8"



MIS10

Microphone stand + bag

Code : H10068



STAND
 Net weight: 1.8 Kg
 Height: from 95 cm to 1,48 m
 Tripod diameter: 70 cm
 Thread at the end of the pole: 3/8"
 Length of the pole: 77 cm
 Materials:
 - ABS for the tripod and boom hinge
 - Steel for tubes
 - Rubber for the ends of tubes
 - ABS for the knobs and the pole tip
 Finish: matte black epoxy paint
 COVER
 Slide-fastener (zipper)
 Material: Polyester
 Customized for Audiophony MIC-100T and MIS10 microphone stands
 Maximum diameter: 10 cm
 Maximum height: 110 cm



MS-27

Straight universal microphone stand

Code : B00766



Straight universal microphone stand
 Base in thick cast iron, covered with a beautiful layer of plastic.
 Base diameter: 25cm
 Thread at the end of the pole: 3/8"



MS-25

Adjustable height all-metal pole tripod

Code : B00764



Microphone stand with adjustable swivel boom
 Solid nylon base
 Very good stability
 Pole length: 64cm
 Thread at the end of the pole: 3/8"



MIC5-BAG

Bag for 5 microphone stands

Code : H10009



Customized for the Audiophony MIC-100 stand
 5 separate spaces
 Lateral strap
 Max. diameter of each space: 10 cm
 Height of each space: 100 cm
 28 cm flap



MIC1-BAG

Bag for 1 microphone stand

Code : H10008



Customized for the Audiophony MIC-100 stand
 Side handle
 Maximum diameter: 10 cm
 Maximum height: 104 cm



BAG-MIC

Nylon bag for microphone stand

Code : B00742



Stylish and durable nylon bag for microphone stand
Perfect for MS-25 and MS-26PRO stands



TMIC100

Flexible arm for microphone with XLR cable and table mounting

Code : H10458



TMIC-20

Microphone table stand with heavy base - height 30 cm

Code : H8232



Net weight: 3,3 Kg
Height: 30 cm
Diameter of the base: 22 cm
Thread at the end of the pole: 3/8"
Length of the pole: 74 cm
Materials:
Steel
Rubber on the base
ABS for the knob and the boom tip
Finish: matte black epoxy paint



JB50

Microphone table stand with heavy base - microphone thread : 3/8"

Code : B00702



Microphone table stand
Heavy base
Robust design
Telescopic microphone arm:
Min. length: 320mm
Max. length: 565mm



TMIC-10

Microphone table stand - height 18 cm

Code : H8231



Net weight: 0.24 Kg
Height: 18 cm
Tripod diameter: 26 cm
Thread at the end of the pole: 3/8"
Materials:
Steel
Rubber for the ends of tubes
Finish: matte black epoxy paint



JB52

Microphone table stand, thread: 3/8"

Code : B00700



Microphone table stand.
Innovative design, fully foldable.
thread: 3/8"
Height: 170mm



JB55

Straight table base for microphone

Code : B00704



Straight table base (24 cm to 40 cm)



JB85

Gooseneck 50cm for microphones

Code : B00709



Flexible gooseneck, length 50 cm



JB88

Base for gooseneck (JB85)

Code : B00710



MICROPHONE ACCESSORIES



JB70

Universal clamp for quick-attaching microphone

Code : B00707



Universal clamp for quick-attaching microphone



JB71

Universal clamp for microphone

Code : B00412



Material: ABS
Maximum opening diameter: 40mm



A415

Spring microphone clamp

Code : H0180



Material: Rubber
Supplied with 3/8 to 5/8 insert



A602

Insert microphone clamp

Code : H1078



AD38

Microphone clamp adapter 3/8 to 5/8

Code : H9930



JB75

Metal reduction 5/8 to 3/8 (10 pieces)

Code : B00711



WINDSCREEN BLACK

Set of 5 black foams.

Code : B00415



WINDSCREEN COLOURED

Set of 5 foams in different colors.

Code : B00416



STANDS



KB4

Keyboard stand with double crossbars - Magnesium series

Code : H9663



Net weight: 4.5 Kg
 Height: from 58 to 98 cm
 Width: from 80 to 82 cm
 Length of the upper tubes: 40 cm
 Supported load: 50 Kg max.
 Locking brake
 Materials:
 - Steel for the tubes and bars
 - Rubber for the ends of tubes
 Finish: anthracite epoxy paint



KB-UNO

Keyboard stand

Code : H8226



Net weight: 2.2 Kg
 Height: from 60 cm to 93 cm
 Distance of horizontal crossbars: from 32 cm to 80 cm
 Crossbar length: 30 cm
 Materials:
 - Steel for the stand
 - Rubber for the ends of tubes
 Maximum load: 25 Kg
 Finish: matte black epoxy paint



KB-BAG

Bag for 1 controller or keyboard stand

Code : H10007



Customized for Audiophony KB-ROLL, KB-UNO and KB4 stands
 Side handle
 Maximum width: 50 cm
 Maximum height: 100 cm
 Maximum thickness of the folded stand: 5 cm



KB-EXT70

Extension for control stand - inclined

Code : H8227



Net weight: 1.5 Kg
 Height: 24 cm
 Crossbar incline: 70° compared to the vertical
 Crossbar length: 30 cm
 Materials:
 - Steel for the stand
 - ABS for the knob
 - Rubber for the ends of tubes
 Finish: matte black epoxy paint



KB-EXT90

Extension for control stand - straight

Code : H8228



Net weight: 1.5 Kg
 Height: 24 cm
 Crossbar incline: horizontal
 Length of the traverse: 30 cm
 Materials:
 - Steel for the support
 - ABS for the knob
 - Rubber for the ends of tubes
 Finish: matte black epoxy paint



DJ4

Magnesium series DJ control stand

Code : H9665



Net weight: 15 Kg
 Height: from 68 to 92 cm
 Dimensions of the main tray: 45 x 100 cm
 Dimensions of the top tray: 30 x 60 cm
 Materials:
 - Steel for the tubes, bars and trays
 - ABS for tube tips and knobs
 Finish: anthracite epoxy paint



SUPPORTS



MEDIAstage1

Aluminium stand for mobile phones

Code : H10495



For 3.5 to 5.5 inch phones
 Material: Aluminium
 Dimensions (WxHxD): 38 x 381 x 25 mm
 Folded dimensions (WxHxD):
 38 x 168 x 25 mm
 Arm length (unfolded): 238 mm
 Stand depth: 17,5 mm
 Stand height: 57 to 89 mm
 Weight: 130 grams



MEDIAstage2

Aluminium stand with clamp for mobile phones and tablets

Code : H10496



Suitable for smartphones and tablets from 4 to 11 inches
 Aluminium structure, 500g
 Maximum load 1 kg



MEDIAstage3

Aluminium stand with 1 suction cup for tablets and smartphones

Code : H10494



Suitable for smartphones and tablets from 4 to 11 inches
 Aluminium structure, 500g
 Maximum load 1 kg



MEDIAstage4

Aluminium stand with double suction cups for tablets and smartphones

Code : H10493



Suitable for smartphones and tablets from 4 to 11 inches
 Aluminium structure, 500g
 Maximum load 1 kg



MEDIAstage5

Aluminium stand with 1 suction cup for mobile phones and tablets

Code : H10654



MEDIAstage6

Aluminium stand for mobile phones and tablets

Code : H10655



MEDIA2

Tablet holder to attach to microphone stand

Code : H10457





LAPTOP STAND
Universal computer stand

Code : B03195



MEDIA4
Magnesium series adjustable multimedia stand

Code : H9664



MEDIA3
Laptop stand with table mounts

Code : H10456



Universal laptop stand
Easily attaches to the vertical parts of your flight bag
Easily attaches to a table
Adaptable in many ways, thanks to intelligent design:
Adaptable width, thanks to 4 expansion adapters: 235mm to 285mm
Adaptable height: 250mm to 380mm
Durable and stable metal design in black finish.
All accessories (buttons, table/rack clamps, extension adapter) are included.
Weight: 2.3kg (all included)
Max. height: 380mm
Minimum height: 250mm
Max. width: 285mm
Min. width: 235mm

Net weight: 2.8 Kg
Height: from 17 to 30 cm
Width (from the top): from 29 to 39 cm
Materials:
- Steel
- ABS for the knobs and bar tips
Finish: anthracite epoxy paint



A	EYEM08 Code : H11084	Male hanging ring MWL 140kg	
B	EYEM10 Code : H11085	Male hanging ring MWL 230kg	
C	SUPPLAT Code : H7903	Plastic support plate for 36 mm stand Platinum 180 x 120 mm	
D	M10 Eyebolt (4 pcs) Code : B00658	Eyebolt without M10 screws (4 pcs)	
E	M8 Eyebolt (4 pcs) Code : B00657	Eyebolt without M8 screws (4 pcs)	
F	CPL-35 Code : H8248	Cup with M8 screw for 35 mm stand	
G	HOOK-12 Code : H8844	Harp shackle 12 mm - 500 Kg	

H	SHA1000 Code : H11082	Steel Shackle CMU 1000Kg	
I	SHA1500 Code : H11083	Steel Shackle CMU 1500Kg	
J	C0-12 Code : B02645	Reinforced cup ø12cm.	
K	CPL-28 Code : H8255	Cup with M8 screw For 28 mm stand	
L	C-35 Code : H8247	Metal speaker baseplate	
M	CPL-12 Code : H3239	Super reinforced cup Diameter 12 cm	



WALL BRACKETS

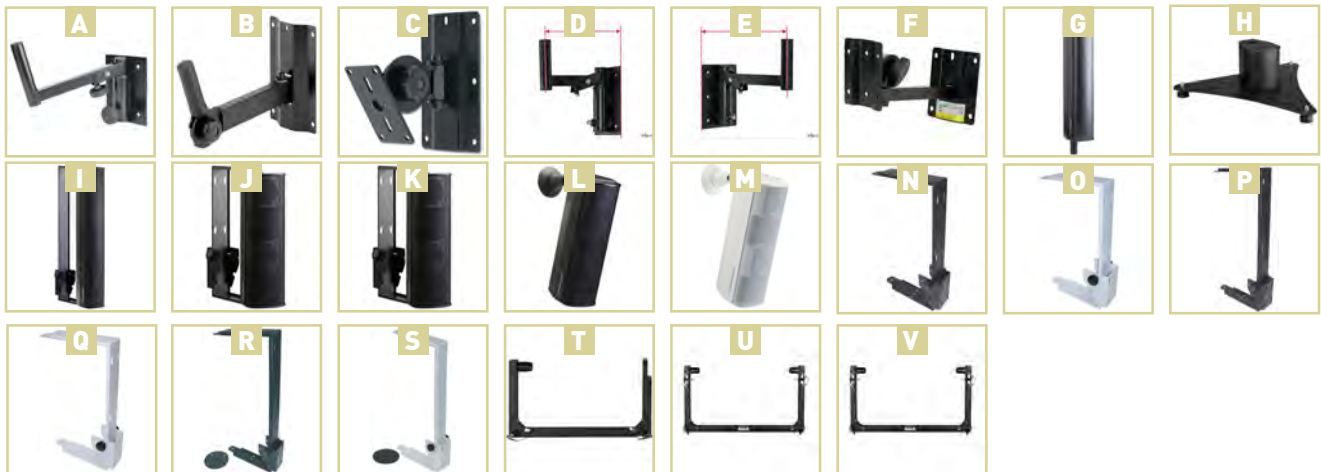

A	SUPWALL Code : H9104	Adjustable wall mount for speakers up to 40Kg
C	BS/6-1 Code : H7906	Adjustable wall mount for speakers up to 20kg
E	WB-L30 Code : B00761	Wall mount 30cm, 40kg
G	iLINEspace60 Code : H10759	Increase height by 60cm for iLINE83B with stackable connector base

B	BS/5-1 Code : H7907	Articulated wall baseplate for large speakers up to 40 Kg
D	WB-L20 Code : B00760	Wall mount 20cm, 40kg
F	BYR Code : H1075	Wall mount for rotating speaker

H	iLINEbase Code : H10760	Floor bracket for iLINE83B and iLINESPACE60
J	iLINE43sup Code : H10755	Wall bracket for iLINE43 column
L	iLINE24sup Code : H10773	Adjustable wall bracket for iLINE23 and iLINE43
N	SUPS6/NO Code : H9705	Hanging bracket for S6 satellite - black
P	SUPS8/NO Code : H9707	Mounting bracket for S8 satellite - black
R	SUPS10/NO Code : H9709	Mounting bracket for S10 satellite - black
T	Bracket for SC-08 Code : B09184	Robust foldable stand for SC-08 speaker
V	Bracket for SC-15 Code : B09186	Robust Foldable Stand for SC-15 Speaker

I	iLINE83sup Code : H10757	Wall bracket for iLINE83 column
K	iLINE23sup Code : H10753	Wall bracket for iLINE23 column
M	iLINE24supw Code : H10945	Swivel wall bracket for iLINE23/iLINE43-White
O	SUPS6/WH Code : H9706	Mounting bracket for S6 satellite - white
Q	SUPS8/WH Code : H9708	Mounting bracket for S8 satellite - white
S	SUPS10/WH Code : H9710	Mounting bracket for S10 satellite - white
U	Bracket for SC-12 Code : B09185	Robust Foldable Stand for SC-12 Speaker

PROTECTIVE COVERS



A	COV-MOJ0500LINE Code : H10867	Protective cover for MOJ0500LINE subwoofer
C	COV-SX15A Code : H10855	Protective bag for SX15A
E	iLINEcov Code : H10768	Protective bag for iLINE series subwoofers
G	COV-ATOM12A Code : H10785	Protective bag for ATOM12A
I	COV-ATOM15ASUB Code : H10787	Protective bag for ATOM15ASUB
K	COV-SR15 Code : H10169	Bag for SR15A speaker
M	COV-SR10 Code : H10167	Bag for SR10A speaker
O	COV-CR25A Code : H10791	Protective bag for CR25A-COMBO
Q	COV-CR80A Code : H10431	Bag for CR80A-COMBO loudspeaker
S	TOURING BAG Code : B00597	Carrying bag for PS-15/PSA-15
U	TOURING BAG - Vibe 15 Code : B00592	Carrying bag for Vibe 15
W	TOURING BAG - Vibe 18 SUB Code : B00595	Carrying Bag for Vibe 18 SUB
Y	COV-SUBOCTAVEMKII Code : H11131	Cover for SUBoctave MKII - Black
A1	TOT-BAGBASES Code : H11137	Bags for TOTEM (ground & top)
C1	TOT-BAGUNO4x150 Code : H11135	Bags for 4x tubes UNO 150
E1	PID1-BAG Code : H10012	Bag for light stand type PID100&240
G1	CAB1-BAG Code : H10010	Bag for one speaker stand type CAB100&200
I1	BAG-STAND Code : B00741	Carrying bag for different light/speaker stands
K1	MIC5-BAG Code : H10009	Bag for 5 microphone tripods type MIC-100
M1	BAG-STAND Code : B00741	Carrying bag for different light/speaker stands

B	COV-SX12A Code : H10854	Protective bag for SX12A
D	iLINEbag Code : H10767	Carrying bag for 2 iLINE HP columns or 2 iLINEspace 60
F	COV-ATOM10A Code : H10784	Protective bag for ATOM10A
H	COV-ATOM15A Code : H10786	Protective bag for ATOM15A
J	COV-ATOM18ASUB Code : H10788	Protective bag for ATOM18ASUB
L	COV-SR12 Code : H10168	Bag for SR12A speaker
N	COV-MOJ01000FX Code : H10350	Travel bag + trolley for MOJ01000FX
P	COV-CR12A Code : H10208	Bag for CR12A-COMBO loudspeaker
R	TOURING BAG - PS-12/PSA-12 Code : B00596	Protective cover for PS-12, PSA-12, PPA-121
T	TOURING BAG - Vibe 12 Code : B00591	Carrying bag for Vibe 12
V	TOURING BAG - Vibe 15 SUB Code : B00594	Carrying bag for Vibe 15 SUB
X	TOURING BAG - Vibe 30 Code : B00593	Carrying bag for Vibe 30
B1	TOT-BAGUNO4x100 Code : H11134	Bags for 4x tubes UNO 100
D1	TOT-BAGUNO4x200 Code : H11136	Bags for 4x tubes UNO 200
F1	PID2-BAG Code : H10013	Bag for 2 light stands type PID100&240
H1	CAB2-BAG Code : H10011	Bag for 2 speaker stands type CAB100&200
J1	MIC1-BAG Code : H10008	Bag for one MIC-100 microphone tripod
L1	BAG-MIC Code : B00742	Carrying bag for mic floor stand
N1	KB-BAG Code : H10007	Bag for X-shaped control stand type KB



BATTERIES



A	PILE-LR03	AAA Battery - Blister alkaline battery 4 x 1.5 V	Code : H8147
B	PILE-LR06	AA Battery - Blister alkaline battery 4 x 1.5 V	Code : H8148
C	PILE-6LR61	Blister alkaline battery 1 x 9 V	Code : H8146
D	PILE-VI-6LR61	VARTA INDUSTRIAL 9V battery (in blister of 20)	Code : H10743
E	PILE-VI-LR6	AA Battery - VARTA INDUSTRIAL 1.5V LR06 battery (in blister of 10)	Code : H10744
F	PILE-VI-LR3	AAA Battery VARTA INDUSTRIAL 1.5V LR03 battery (in blister of 10)	Code : H10745
G	PILE-VCR2025	VARTA CR2025 button battery (in blister of 10)	Code : H10746



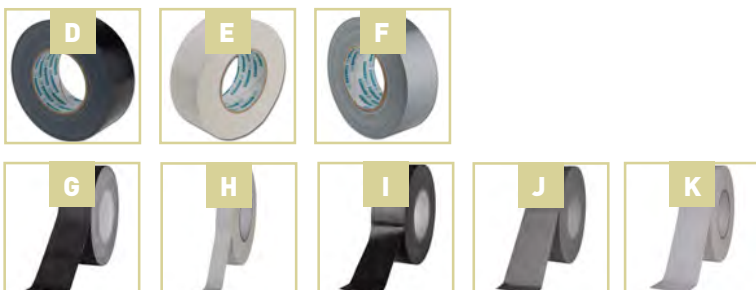











GAFFAS



D	GAFFA-PRO/NO	Gaffa 50mm x 50m professional black	Code : H3956
E	GAFFA-PRO/WH	Roll of 50 m x 5 cm canvas - White	Code : H8874
F	GAFFA-PRO/GR	Roll of 50m x 5cm canvas - Grey	Code : H8875
G	GAFFER TAPE MATT 50 BLACK	High quality matt black canvas tape of 50m x 5 cm.	Code : B06104
H	GAFFER TAPE STD 25 WHITE	High quality white tape 50m x 25mm.	Code : B06103
I	GAFFER TAPE STD 50 BLACK	High quality black canvas tape 50m x 5 cm.	Code : B06100
J	GAFFER TAPE STD 50 GREY	High-quality grey canvas tape 50m x 5 cm.	Code : B06101
K	GAFFER TAPE STD 50 WHITE	High-quality white canvas tape 50m x 5 cm.	Code : B06102

COLOURING



A	COLOR FILTER Sheet «Congo Blue 181»	1.22 x 0.53m "Congo Blue 181" colour sheet	Code : B04564	 Hilec LIGHT & SOUND ACCESSORIES
B	COLOR FILTER Sheet «Dark Green 124»	1.22 x 0.53m "Dark Green 124" colour sheet	Code : B04566	 Hilec LIGHT & SOUND ACCESSORIES
C	COLOR FILTER Sheet «Magenta 113»	1.22 x 0.53m "Magenta 113" colour sheet	Code : B04567	 Hilec LIGHT & SOUND ACCESSORIES
D	COLOR FILTER Sheet «Mauve 126»	1.22 x 0.53m "Mauve 126" colour sheet	Code : B04569	 Hilec LIGHT & SOUND ACCESSORIES
E	COLOR FILTER Sheet «Medium Blue-Green»	1.22 x 0.53m "Medium Blue-Green" colour sheet	Code : B04568	 Hilec LIGHT & SOUND ACCESSORIES
F	COLOR FILTER Sheet «Orange 105»	1.22 x 0.53m "Orange 105" colour sheet	Code : B04561	 Hilec LIGHT & SOUND ACCESSORIES
G	COLOR FILTER Sheet «Primary Green 139»	1.22 x 0.53m "Primary Green 139" colour sheet	Code : B04565	 Hilec LIGHT & SOUND ACCESSORIES
H	COLOR FILTER Sheet «Primary Red 106»	1.22 x 0.53m "Primary Red 106" colour sheet	Code : B04562	 Hilec LIGHT & SOUND ACCESSORIES
I	COLOR FILTER Sheet «Sky Blue 068»	1.22 x 0.53m "Sky Blue 068" colour sheet	Code : B04563	 Hilec LIGHT & SOUND ACCESSORIES
J	COLOR FILTER Sheet «Vanity Fair 793»	1.22 x 0.53m "Vanity Fair 793" colour sheet	Code : B04570	 Hilec LIGHT & SOUND ACCESSORIES
K	COLOR FILTER Sheet «Yellow 101»	1.22 x 0.53m "Yellow 101" colour sheet	Code : B04560	 Hilec LIGHT & SOUND ACCESSORIES
L	FILTER SHEETS PAR56 SH - 10 col.	Set of filters, 10 different colours	Code : B04551	 Hilec LIGHT & SOUND ACCESSORIES
M	FILTER SHEETS PAR56 SH - 5 col.	Set of filters, 5 different colours	Code : B04550	 Hilec LIGHT & SOUND ACCESSORIES
N	FILTER SHEETS PAR64 PRO- 10 col.	Set of filters, 10 different colours	Code : B04555	 Hilec LIGHT & SOUND ACCESSORIES
O	FILTER SHEETS PAR64 PRO- 5 col.	Set of filters, 5 different colours	Code : B04554	 Hilec LIGHT & SOUND ACCESSORIES



GOOSENECK LIGHTS





A	Snake16USB	Flexible lamp with 6 white COB LEDs - USB	Code : H10802
B	Snake16	1-arm desk lamp with 6 white COB LEDs	Code : H10803
C	Snake23DUO	2-arm desk lamp with 3 white COB LEDs	Code : H10804
D	Snake118DeskW	Desk lamp with 18 warm white COB LEDs	Code : H10805
E	Snake118DeskC	Desk lamp with 18 cool white COB LEDs	Code : H10806
F	Snake16M	Flexible LED lamp + magnetic baseplate + Battery	Code : H10807
G	Snake26Rack	2-arm USB rack light with white LEDs	Code : H10808
H	Snake16RGBUSB	Flexible lamp with 6 RGB COB LEDs - USB	Code : H10809



VELCRO







A	VELCRO-30 Code : H8876	VELCRO 25 x 300 mm strap	
B	VELCRO-60 Code : H8877	VELCRO 45 x 600 mm strip	

LINE AUDIO CABLES



	CFLAT-XXMF/0.5 Code : H10810	XLR male / XLR female flat cable - 0.5m
	CFLAT-XXMF/1 Code : H10811	XLR female / XLR male flat cable - 1m
	CFLAT-XXMF/1.5 Code : H10812	XLR female / XLR male flat cord - 1.5m



	CFLAT-JSXF/0.5 Code : H10816	TRS Male / XLR Female 6.35 jack flat cable - 0.5m
	CFLAT-JSXF/1 Code : H10817	TRS Male / XLR Female 6.35 jack flat cable - 1m
	CFLAT-JSXF/1.5 Code : H10818	XLR Female / Jack 6.35 TRS Male flat cord - 1.5m

	CFLAT-RCA/0.5 Code : H10822	RCA male / RCA male flat cable - 0.5m
	CFLAT-RCA/1 Code : H10823	RCA male / RCA male flat cable - 1m
	CFLAT-RCA/1.5 Code : H10824	RCA male / RCA male flat cord - 1.5m





	CL-32/1.5 Code : H10668	Stereo / 2 x XLR male 3.5 jack cable - 1.5m
	CL-32/3 Code : H10669	Stereo / 2 x XLR male 3.5 jack cable - 3m



	CL-29/0.6 Code : H10671	1 XLR male / 2 x XLR female cable - 0.6m
------------------------------------------------------------------------------------	-----------------------------------	------------------------------------------



	CL-41/1.5 Code : H10674	2 x XLR male / 2 x stereo male jack cable - 1.5m
	CL-41/3 Code : H10675	2 x XLR male / 2 x stereo male jack cable - 3m



	CL-43/1.5 Code : H10678	2 x XLR female / 2 x stereo male jack cable - 1.5m
	CL-43/3 Code : H10679	2 x XLR female / 2 x stereo male jack cable - 3m

	ADAPT2010 Code : H10697	Female / 2 x RCA male 3.5 jack cable
-------------------------------------------------------------------------------------	-----------------------------------	--------------------------------------



	CL-05/1.5 Code : H7976	Male 6mm jack / Mono male jack line cable - 1.5m
	CL-05/3 Code : H7977	Male 6mm jack / Mono male jack line cable - 3m
	CL-05/6 Code : H7978	Male 6mm jack / Mono male jack line cable - 6m
	CL-05/10 Code : H7979	Male 6mm jack / Mono male jack line cable - 10m



	CFLAT-JSJS/0.5 Code : H10813	TRS jack / TRS jack flat cable - 0.5m
	CFLAT-JSJS/1 Code : H10814	TRS jack / TRS jack flat cable - 1m
	CFLAT-JSJS/1.5 Code : H10815	Jack TRS / Jack TRS flat cord - 1.5m





	CFLAT-JSXM/0.5 Code : H10819	TRS Male / XLR Male 6.35 jack flat cable - 0.5m
	CFLAT-JSXM/1 Code : H10820	TRS Male / XLR Male 6.35 jack flat cable - 1m
	CFLAT-JSXM/1.5 Code : H10821	XLR Male / Jack 6.35 TRS Male flat cord - 1.5m

	CFLAT-JMJM/0.5 Code : H10825	6.35 J mono / 6.35 J mono flat cable - 0.5
	CFLAT-JMJM/1 Code : H10826	Mono 6.35 jack / mono 6.35 jack flat cable - 1
	CFLAT-JMJM/1.5 Code : H10827	J 6.35 Mono / J 6.35 mono flat cord - 1.5



	CL-28/0.6 Code : H10670	1 XLR female / 2 x XLR male cable - 0.6m
-----------------------------------------------------------------------------------	-----------------------------------	------------------------------------------

	CL-40/1.5 Code : H10672	2 x mono 6.35 jack / 2 x XLR male cable - 1.5m
	CL-40/3 Code : H10673	2 x mono 6.35 jack / 2 x XLR male cable - 3m

	CL-42/1.5 Code : H10676	2 x XLR female / 2 x mono male jack cable - 1.5m
	CL-42/3 Code : H10677	2 x XLR female / 2 x mono male jack cable - 3m

	CL-2XM2XF/0.6 Code : H10680	2 x XLR Male / 2 x XLR Female cable - 0.6m
	CL-2XM2XF/1.5 Code : H10681	2 x XLR female / 2 x XLR Male cable - 1.5m
	CL-2XM2XF/3 Code : H10682	2 x XLR Male / 2 x XLR female cable - 3m
	CL-2XM2XF/6 Code : H10683	2 x XLR Male / 2 x XLR female cable - 6m

	ADAPT2020 Code : H10698	1 stereo male 3.5 jack / 2 stereo female 3.5 jack cable - Black
-------------------------------------------------------------------------------------	-----------------------------------	-----------------------------------------------------------------

	CL/JMJM-1,5 Code : H7980	Male jack / Mono male jack line cable - 1.5m
	CL/JMJM-3 Code : H7981	Male jack / Mono male jack line cable - 3m
	CL/JMJM-6 Code : H7982	Male jack / Mono male jack line cable - 6m
	CL/JMJM-10 Code : H7983	Male jack / Mono male jack line cable - 10m
	CL/JMJM-20 Code : H7984	Male jack / Mono male jack line cable - 20m



LINE AUDIO CABLES

tasker



A	PRE-DPR-RF311black Code : B01050	MF114ZW01 - Signal de câble assemblé, C11
C	PRE-DPR-RF3110black Code : B01053	MF114ZW10 - Signal de câble assemblé, C1
E	PRE-DPR-RF333black Code : B01060	MF128ZW03 - Signal de câble assemblé, C12
G	PRE-DPR-RF3310black Code : B01062	MF128ZW10 - Signal de câble assemblé, C1
I	RF143 Code : B01000	Signal de câble assemblé, C114bl+NP2C/NP2C 3m
K	RF149 Code : B01002	Signal de câble assemblé, C114bl+NP2C/NP2C 9m
M	RF213 Code : B01005	Signal de câble assemblé, C114bl+NP2C/NC3FX 3m
O	RF219 Code : B01007	Signal de câble assemblé, C114bl+NP2C/NC3FX 9m

B	PRE-DPR-RF313black Code : B01051	MF114ZW03 - Signal de câble assemblé, C11
D	PRE-DPR-RF3120black Code : B01054	MF114ZW20 - Signal de câble assemblé, C1
F	PRE-DPR-RF335black Code : B01061	MF128ZW05 - Signal de câble assemblé, C12
H	PRE-DPR-RF3320black Code : B01063	MF128ZW20 - Signal de câble assemblé, C1
J	RF146 Code : B01001	Signal de câble assemblé, C114bl+NP2C/NP2C 6m
L	RF1412 Code : B01003	Signal de câble assemblé, C114bl+NP2C/NP2C 12m
N	RF216 Code : B01006	Signal de câble assemblé, C114bl+NP2C/NC3FX 6m
P	RF2112 Code : B01008	Signal de câble assemblé, C114bl+NP2C/NC3FX 12m

SPEAKER CABLES

tasker



A	PRE-DPR-SS T23ZW03 Code : B01065	Câble de haut-parleur assemblé, 2xAW13 + 2xNL2
C	PRE-DPR-SS T23ZW10 Code : B01067	Câble de haut-parleur assemblé, 2xAW13 + 2xNL2
E	PRE-DPR-SS T23ZW20 Code : B01069	Câble de haut-parleur assemblé, 2xAW13 + 2xNL2
G	PRE-DPR-SS T27ZW05 Code : B01071	Câble haut-parleur assemblé, 4xAWG13 + 2xNL
I	PRE-DPR-SS T27ZW15 Code : B01073	Câble haut-parleur assemblé, 4xAWG13 + 2xNL

B	PRE-DPR-SS T23ZW05 Code : B01066	Câble de haut-parleur assemblé, 2xAW13 + 2xNL2
D	PRE-DPR-SS T23ZW15 Code : B01068	Câble de haut-parleur assemblé, 2xAW13 + 2xNL2
F	PRE-DPR-SS T27ZW03 Code : B01070	Câble haut-parleur assemblé, 4xAWG13 + 2xNL
H	PRE-DPR-SS T27ZW10 Code : B01072	Câble haut-parleur assemblé, 4xAWG13 + 2xNL
J	PRE-DPR-SS T27ZW20 Code : B01074	Câble haut-parleur assemblé, 4xAWG13 + 2xNL



LINE AUDIO CABLES



CL-07/1.5 Code : H7995	Stereo Male jack 6,35 mm / stereo Male jack 6,35 mm line cable - 1.50m
CL-07/3 Code : H7996	Stereo Male jack 6,35 mm / stereo Male jack 6,35 mm line cable - 3m
CL-07/6 Code : H7997	Stereo Male jack 6,35 mm / stereo Male jack 6,35 mm line cable - 6m
CL-07/10 Code : H7998	Stereo Male jack 6,35 mm / stereo Male jack 6,35 mm line cable - 10m



CL-71/1.5 Code : H7999	Stereo Male 3.5 mm jack / stereo Male 6.35 jack line cable - 1.50m
CL-71/3 Code : H8000	Stereo Male 3.5 mm jack / stereo Male 6.35 jack line cable - 3m
CL-71/6 Code : H8001	Stereo Male 3.5 mm jack / stereo Male 6.35 jack line cable - 6m
CL-71/10 Code : H8002	Stereo Male 3.5 mm jack / stereo Male 6.35 jack line cable - 10m



CL-72/1.5 Code : H8003	Jack 3,5 mm stereo Male / Jack 3,5 stereo Male cord line - 1.50m
CL-72/3 Code : H8004	Jack 3,5 mm Stereo Male / Jack 3,5 stereo Male cord line - 3m
CL-72/6 Code : H8005	Jack 3,5 mm Stereo Male / Jack 3,5 stereo Male cord line - 6m
CL-72/10 Code : H8006	Jack 3,5 mm stereo Male / Jack 3,5 stereo Male cord line - 10m



CL-23/1.5 Code : H8007	2x4mm 2x Male jack 6,35 mm / 2xRCA Male line cable - 1.5m
CL-23/3 Code : H8008	2x4mm 2x Male jack 6,35 mm / 2xRCA Male line cable - 3m



CL-35/1.5 Code : H8009	2x4mm 1 stereo Male jack 6,35 mm / 2xRCA Male line cable - 1.5m
CL-35/3 Code : H8010	2x4mm 1 stereo Male jack 6,35 mm / 2xRCA Male line cable - 3m
CL-35/6 Code : H8011	2x4mm 1 stereo Male jack 6,35 mm / 2xRCA Male line cable - 6m



CL-36/1.5 Code : H9294	Stereo male 6.35 jack / 2 x mono 6.35 jack line cable - 1.5m
CL-36/3 Code : H9295	Stereo male 6.35 jack / 2 x mono 6.35 jack line cable - 3m



CL-25/1.5 Code : H8165	2x4mm 2xXLR Female / 2xRCA Male line cable - 1.5m
CL-25/3 Code : H8166	2x4mm 2xXLR Female / 2xRCA Male line cable - 3m



CL-26/1.5 Code : H8167	2x4mm 2xXLR Male / 2xRCA Male line cable - 1.5m
CL-26/3 Code : H8168	2x4mm 2xXLR Male / 2xRCA Male line cable - 3m



FL-22/1.5 Code : H8012	2x4mm 2x Male jack 6,35 mm / 2x Mono male jack 6,35 mm line cable - 1.5m
FL-22/3 Code : H8013	2x4mm 2x Male jack 6,35 mm / 2x Mono male jack 6,35 mm line cable - 3m
FL-22/6 Code : H8014	2x4mm 2x Male jack 6,35 mm / 2x Mono Male jack 6,35 mm line cable - 6m



CL-31/1.5 Code : H8015	2x4mm 1x stereo Male 3.5 jack / 2x Male jack 6,35 mm line cable - 1.5m
CL-31/3 Code : H8016	2x4mm 1x stereo Male 3.5 jack / 2x Male jack 6,35 mm line cable - 3m



CL-30/1.5 Code : H8017	2x4mm 1x stereo Male 3.5 jack / 2xRCA Male line cable 1.5m
CL-30/3 Code : H8018	2x4mm 1x stereo Male 3.5 jack / 2xRCA Male line cable 3m



CL-51/0.6 Code : H9299	DIN 5-pin male / DIN 5-pin male midi cable - 0.6m
CL-51/1 Code : H9300	DIN 5-pin male / DIN 5-pin male midi cable - 1m
CL-51/3 Code : H8019	DIN 5-pin male / DIN 5-pin male midi cable - 3m
CL-51/6 Code : H8020	DIN 5-pin male / DIN 5-pin male midi cable - 6m



RCA1/C Code : H0049	2 RCA male / 2 RCA male cable - 1.2 m
------------------------	---------------------------------------



CL-24/1.5 Code : H7964	2x4mm 2xRCA Male / 2xRCA Male line cable - 1.5m
CL-24/3 Code : H7965	2x4mm 2xRCA Male / 2xRCA Male line cable - 3m
CL-24/6 Code : H7966	2x4mm 2xRCA Male / 2xRCA Male line cable - 6m



CL-27/1.5 Code : H7967	2xRCA Female / 2xRCA Male line cable - 1.5m
CL-27/3 Code : H7968	2xRCA Female / 2xRCA Male line cable - 3m
CL-27/6 Code : H7969	2xRCA Female / 2xRCA Male line cable - 6m



RCA11/C Code : H7970	High quality cable - 2 RCA male / 2 RCA male - 1.20m
RCA13/C Code : H7971	High quality cable - 2 RCA male / 2 RCA male - 3m
RCA15/C Code : H7972	High quality cable - 2 RCA male / 2 RCA male - 5m



RCA/PH Code : H7973	2 RCA male / 2 RCA male cable + mass - 3m
------------------------	-------------------------------------------



INSERT-JACKm-1M5 Code : B01240	Insert cable - stereo jack 6,35 mm - 2x mono jack 6,35 mm - 1.5m
INSERT-JACKm-3M Code : B01241	Insert cable - stereo jack 6,35 mm - 2x mono jack 6,35 mm - 3m

MICROPHONE CABLES



CM/XFXM-0,6 Code : H9298	XLR female / XLR male microphone cable - 0,6m
CM/XFXM-1,5 Code : H7947	XLR female / XLR male microphone cable - 1.5m
CM/XFXM-3 Code : H7948	XLR female / XLR male microphone cable - 3m
CM/XFXM-6 Code : H7949	XLR female / XLR male microphone cable - 6m
CM/XFXM-10 Code : H7950	XLR female / XLR male microphone cable - 10m
CM/XFXM-20 Code : H7951	XLR female / XLR male microphone cable - 20m



CM/XFJM-1,5 Code : H7952	XLR female / male jack 6,35 mm microphone cable - 1.5m
CM/XFJM-3 Code : H7953	XLR female / male jack 6,35 mm microphone cable - 3m
CM/XFJM-6 Code : H7954	XLR female / male jack 6,35 mm microphone cable - 6m
CM/XFJM-10 Code : H7955	XLR female / male jack 6,35 mm microphone cable - 10m
CM/XFJM-20 Code : H7956	XLR female / male jack 6,35 mm microphone cable - 20m



CM/XMJM-1,5 Code : H9296	XLR male / mono male 6.35 jack microphone cable - 1.5m
CM/XMJM-3 Code : H9297	XLR male / mono male 6.35 jack microphone cable - 3m
CM/XMJM-6 Code : H7957	XLR male / mono male 6.35 jack microphone cable - 6m
CM/XMJM-10 Code : H7958	XLR male / mono male 6.35 jack microphone cable - 10m



SPEAKER CABLES

	CH/JMJM-1.5 Code : H8023	Male jack 6,35 mm / Male jack 6,35 mm 2x1.5 HP cable - 1.5m
	CH/JMJM-3 Code : H8024	Male jack 6,35 mm / Male jack 6,35 mm 2x1.5 HP cable - 3m
	CH/JMJM-10 Code : H8025	Male jack 6,35 mm / Male jack 6,35 mm 2x1.5 HP cable - 10m
	CH/JMJM-15 Code : H8026	Male jack / Male jack 2x1.5 HP cable - 15m

	CSP215/0.5 Code : H10695	2 speaker cable x 1.5 mm ² speakon/speakon NEUTRIK - 0.5m
	CSP215/1 Code : H10696	2 speaker cable x 1.5 mm ² speakon/speakon NEUTRIK - 1m
	CSP215/3 Code : H9840	2 speaker cable x 1.5 mm ² speakon/speakon NEUTRIK - 3m
	CSP215/6 Code : H9841	2 speaker cable x 1.5 mm ² speakon/speakon NEUTRIK - 6m
	CSP215/10 Code : H9842	2 speaker cable x 1.5 mm ² speakon/speakon NEUTRIK - 10m

	CH/SMJM-3 Code : H8034	Speakon Male / Male jack 6,35 mm 2x1.5 HP cable - 3m
	CH/SMJM-6 Code : H8035	Speakon Male / Male jack 6,35 mm 2x1.5 HP cable - 6m
	CH/SMJM-10 Code : H8036	Speakon Male / Male jack 6,35 mm 2x1.5 HP cable - 10m
	CH/SMJM-20 Code : H8037	Speakon Male / Male jack 6,35 mm 2x1.5 HP cable - 20m

	CS-21/3 Code : H8038	Speakon Male / speakon Male 2x1.5 HP cable - 3m
	CS-21/6 Code : H8039	Speakon Male / speakon Male 2x1.5 HP cable - 6m
	CS-21/10 Code : H8040	Speakon Male / speakon Male 2x1.5 HP cable - 10m
	CS-21/15 Code : H8041	Speakon Male / speakon Male 2x1.5 HP cable - 15m
	CS-21/20 Code : H8042	Speakon Male / speakon Male 2x1.5 HP cable - 20m

NEUTRIK

DMX CABLES

	CDU0-10 Code : H9274	VDE / CEE - XLR male / XLR female hybrid audio cable - 10 metres
	CDU0-20 Code : H9293	VDE / CEE - XLR male / XLR female Hybrid Sound Cord - 20 meters

	AUDIO COMBI CABLE SCHUKO/XLR-10M Code : B01404	VDE / CEE - XLR male / XLR female Hybrid Sound Cord - 10 meters
	AUDIO COMBI CABLE SCHUKO/XLR-20M Code : B01405	VDE / CEE - XLR male / XLR female Hybrid Sound Cord - 20 meters
	AUDIO COMBI CABLE SCHUKO/XLR-5M Code : B01403	VDE / CEE - XLR male / XLR female Hybrid Sound Cord - 5 meters

	AUDIO COMBI CABLE IEC/XLR-10M Code : B01401	IEC / XLR Male / XLR Female Hybrid Sound Cord - 10 Meters
	AUDIO COMBI CABLE IEC/XLR-20M Code : B01402	IEC / XLR Male / XLR Female Hybrid Sound Cord - 20 Meters
	AUDIO COMBI CABLE IEC/XLR-5M Code : B01400	IEC / XLR Male / XLR Female hybrid audio cable - 5 metres

CONVERTER DANTE ⇔ ANALOG

	NEW
	ConvD2in Code : H11049

	NEW
	ConvD2out Code : H11050



DMX CABLES

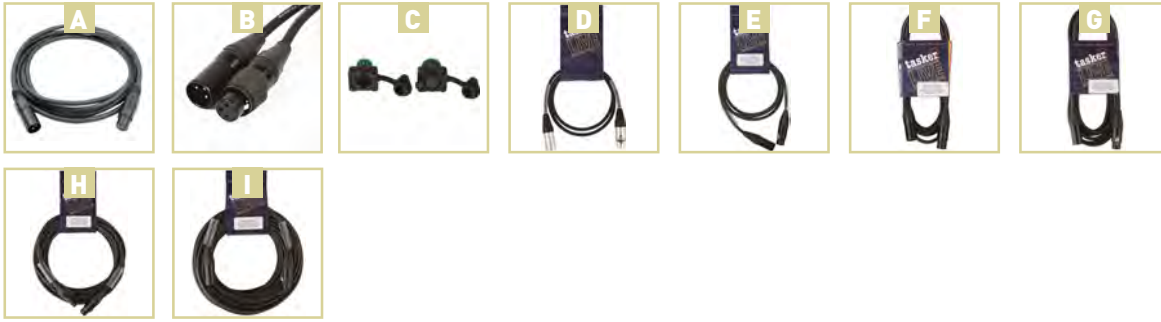

A	CDMX-0.6 Code : H10699	DMX XLR male / XLR female 3 pin cable - 0.6m
	CDMX-1 Code : H9273	Cable for DMX XLR Male / XLR female 3 pins Length: 1 m
	CDMX-1.5 Code : H9288	Cord for DMX XLR Male / XLR female 3 pins Length: 1.5 m
	CDMX-3 Code : H9289	Cord for DMX XLR Male / XLR female 3 pins Length: 3 m
	CDMX-5 Code : H9290	Cord for DMX XLR Male / XLR female 3 pins Length: 5 m
	CDMX-10 Code : H9291	Cord for DMX XLR Male / XLR female 3 pins Length: 10 m
	CDMX-20 Code : H9292	Cord for DMX XLR Male / XLR female 3 pins Length: 20 m
B	IPCD-1 Code : H10722	DMX 3P waterproof connection cable for IPZOOM - 1m
	IPCD-2 Code : H10723	DMX 3P waterproof connection cable for IPZOOM - 2m
	IPCD-5 Code : H10724	DMX 3P waterproof connection cable for IPZOOM - 5m

C	BT-XLR3T05 KIT Code : B05523	Modification kit to modify IP XLR3pin to 5 pins
D	PRE-DPR-RF3301.5BLACK Code : B01424	MF128ZW1,5 - Câble DMX 1,5m avec neutre
E	PRE-5M5F1038ZW1,5 (BAG) Code : B01407	Câble DMX 1,5m avec Neutrik XLR 5p black
F	PRE-5M5F1038ZW03 (BAG) Code : B01408	Câble DMX 3m avec Neutrik XLR 5p black
G	PRE-5M5F1038ZW05 (BAG) Code : B01409	Câble DMX 5m avec Neutrik XLR 5p black
H	PRE-5M5F1038ZW10 (BAG) Code : B01410	Câble DMX 10m avec Neutrik XLR 5p black
I	PRE-5M5F1038ZW20 (BAG) Code : B01411	Câble DMX 20m avec Neutrik XLR 5p black

RJ45 / XLR ADAPTERS AUDIO & DMX



NEW



BOXRJ4XF3
Code : H11044

RJ45/XLR3F adapter box for audio/DMX signal

NEW



BOXRJ4XF5
Code : H11046

RJ45/XLR5F adapter box for audio/DMX signal

NEW



BOXRJ4XM3
Code : H11043

RJ45/XLR3M adapter box for audio/DMX signal

NEW





BOXRJ4XM5
Code : H11045

RJ45/XLR5M adapter box for audio/DMX signal



DMX COMBI CABLES

	CPCDMXLINK-1 Code : H10686	POWERCON / XLR hybrid cable 3G1.5mm ² - 1m
	CPCDMXLINK-3 Code : H10687	POWERCON / XLR hybrid cable 3G1.5mm ² - 3m
	CPCDMXLINK-5 Code : H10688	POWERCON / XLR hybrid cable 3G1.5mm ² - 5m

	CPCDMXIN-3 Code : H10689	POWERCON-PC16A / XLR hybrid cable 3G1.5mm ² - 3m
	CPCDMXIN-5 Code : H10690	POWERCON-PC16A / XLR hybrid cable 3G1.5mm ² - 5m
	CPCDMXIN-10 Code : H10691	POWERCON-PC16A / XLR hybrid cable 3G1.5mm ² - 10m

	COMBI CABLE IEC/XLR-1M3 Code : B01255	Power(IEC)+DMX cable 1.3m
	COMBI CABLE IEC/XLR 3M Code : B01256	Power(IEC)+DMX cable 3.0m
	COMBI CABLE IEC/XLR 5M Code : B01257	Power(IEC)+DMX cable 5.0m
	COMBI CABLE IEC/XLR 10M Code : B01258	Power(IEC)+DMX cable 10.0m

	POWERCON/XLR COMBI 3x1.5mm ² CABLE 1M3 Code : B01263	1.3 m POWERCON Neutrik / XLR hybrid cable 3G1.5mm ²
	POWERCON/XLR COMBI 3x1.5mm ² CABLE 3M Code : B01264	3m POWERCON Neutrik / XLR hybrid cable 3G1.5mm ²
	POWERCON/XLR COMBI 3x1.5mm ² CABLE 5M Code : B01265	5m POWERCON Neutrik / XLR hybrid cable 3G1.5mm ²
	POWERCON/XLR COMBI 3x1.5mm ² CABLE 10M Code : B01266	10m POWERCON Neutrik / XLR hybrid cable 3G1.5mm ²

MULTI SOCKETS

	MULTISOCKET4-F** Code : B01352	

	MULTISOCKET4-G** Code : B01353	
	MULT4E Code : H10842	Power outlets 4 European outlets

	MULTIP4F Code : H10845	Power outlets 4 French sockets - IP44
	MULTIP4E Code : H10846	Power outlets 4 European outlets - IP44

	MULTIP6F Code : H10843	French extension socket 6 outlets - IP44
	MULTIP6E Code : H10844	European extension socket 6 outlets - IP44

	MULT6E Code : H10841	European extension socket 6 outlets

	MULTISOCKET4PRO-F-3M** Code : B01387	
	MULTISOCKET4PRO-F-5M** Code : B01389	

	MULTISOCKET4PRO-G-3M** Code : B01388	
	MULTISOCKET4PRO-G-5M** Code : B01390	

*5-pole CEE extension cable with transparent heat-shrinkable sheath for custom labels.

**4-outlet power distribution box with sliding mounting bracket and transparent heat-shrinkable sheath for custom labels.

	CPCLINK-0.5	NAC3FCA / NAC3FCB 3G0.75mm cable ² ET Code : H10692	3G2mm ² - 0.5m
	CPCLINK-1	NAC3FCA / NAC3FCB 3G0.75mm cable ² ET Code : H10693	3G2mm ² - 1m
	CPCLINK-1.5	NAC3FCA / NAC3FCB 3G0.75mm cable ² ET Code : H10694	3G2mm ² - 1.5m

	IPCP-1	Waterproof electrical connection cable for IPZOOM -1m
	IPCP-2	Waterproof electrical connection cable for IPZOOM -2m
	IPCP-5	Waterproof electrical connection cable for IPZOOM -5m

	CPCIN-1	NAC3FCA / 3G1.5mm cable ² / PC16A - 1m Code : H10684
	POWER CABLE CEE7/7-PowerCON 2M	Power cable CEE7/7 - PowerCON
	CPCIN-2.5	NAC3FCA / 3G1.5mm cable ² / PC16A - 2.5m Code : H10685

	CPCIN3	Europe male / SEETRONIC cable - 3m / 3G1.5mm ²
	CPCIN5	Europe male / SEETRONIC cable - 5m / 3G1.5mm ²

	CEE-CABLE-32A-5G6-10M*	Code : B01392
	CEE-CABLE-32A-5G6-20M*	Code : B01393
	CEE-CABLE-32A-5G6-5M*	Code : B01391

	CEE-CABLE-63A-5G16-10M*	Code : B01395
	CEE-CABLE-63A-5G16-20M*	Code : B01396
	CEE-CABLE-63A-5G16-5M*	Code : B01394

	IECEUR3	IEC female / Europe male cable - 3m / 3G1mm ²
	IECEUR5	IEC female / Europe male cable - 5m / 3G1mm ²
	POWER CABLE CEE7/7-IEC 2M	Code : B01350 CEE7/7-IEC power cable 2M

	IECMF-1	IEC male / female 1m cables Code : H9889
	IEC Cable M/F 1M	IEC male / female 1m cables Code : B04151
	IECMF-3	IEC male / female 3m cables Code : H9890
	IECMF-5	IEC male / female 5m cables Code : H9891
	IEC Cable M/F 5M	IEC male / female 5m cables Code : B04152
	IECMF-7	IEC male / female 7m cables Code : H9892

	ALIM315/3	Extension cable with rubber plugs H07RN- F3G1.5 - 3m Code : H9848
	ALIM315/5	Extension cable with rubber plugs H07RN- F3G1.5 - 5m Code : H9849
	ALIM315/10	Extension cable with rubber plugs H07RN- F3G1.5 - 10m Code : H9850
	ALIM325/3	Extension cable with rubber plugs H07RN- F3G2.5 - 3m Code : H9851
	ALIM325/5	Extension cable with rubber plugs H07RN- F3G2.5 - 5m Code : H9852
	ALIM325/10	Extension cable with rubber plugs H07RN- F3G2.5 - 10m Code : H9853

	POWERCABLE-3G1,5-10M-F	Extension cable 3G1.5, 10m and French Schuko plug Code : B01377
	POWERCABLE-3G1,5-10M-G	Extension cable 3G1.5, 10m and German Schuko plug Code : B01380
	POWERCABLE-3G1,5-5M-F	Extension cable 3G1.5, 5m and French Schuko plug Code : B01376
	POWERCABLE-3G1,5-5M-G	Extension cable 3G1.5, 5m and German Schuko plug Code : B01379
	POWERCABLE-3G1,5-3M-F	Extension cable 3G1.5, 3m and French Schuko plug Code : B01375
	POWERCABLE-3G1,5-3M-G	Extension cable 3G1.5, 3m and German Schuko plug Code : B01378

	POWERCABLE TRUE1 2M	Câble d'alimentation 3x1,5mm ² avec Powercon TRUE Code : B01440
-------------------------------------------------------------------------------------	---------------------	----------------------------------------------------------------------------------

	POWERCABLE-3G2,5-20M-F	Extension cable 3G2.5, 20m and French Schuko plug Code : B01383
	POWERCABLE-3G2,5-20M-G	Extension cable 3G2.5, 20m and German Schuko plug Code : B01386
	POWERCABLE-3G2,5-15M-F	Powercable 3G2,5 and French Shuko connectors Code : B01447
	POWERCABLE-3G2,5-10M-F	Extension cable 3G2.5, 10m and French Schuko plug Code : B01382
	POWERCABLE-3G2,5-10M-G	Extension cable 3G2.5, 10m and German Schuko plug Code : B01385
	POWERCABLE-3G2,5-5M-F	Extension cable 3G2.5, 5m and French Schuko plug Code : B01381
	POWERCABLE-3G2,5-5M-G	Extension cable 3G2.5, 5m and German Schuko plug Code : B01384
	POWERCABLE-3G2,5-3M-F	Extension cable 3G2.5, 3m and French Schuko plug Code : B01397
	POWERCABLE-3G2,5-3M-G	Extension cable 3G2.5, 3m and German Schuko plug Code : B01398

	TRUE1/XLR-3P COMBI CABLE 1,5M	DMX + POWER 3x1,5mm ² câble T Code : B01425
	TRUE1/XLR-5P COMBI CABLE 1,5M	DMX + POWER 3x1,5mm ² câble T Code : B01412
	TRUE1/XLR-3P COMBI CABLE 3M	DMX + POWER 3x1,5mm ² câble TRU Code : B01426
	TRUE1/XLR-5P COMBI CABLE 3M	DMX + POWER 3x1,5mm ² câble TRU Code : B01413
	TRUE1/XLR-3P COMBI CABLE 5M	DMX + POWER 3x1,5mm ² câble TRU Code : B01427
	TRUE1/XLR-5P COMBI CABLE 5M	DMX + POWER 3x1,5mm ² câble TRU Code : B01414

	ADAPTER POWERCON M/F-TRUE1 F	Adapter Powercon M/F (NAC3FCB - NAC3FCA) to Powercon TRUE1 F (NAC3FX-W) Code : B01441
-------------------------------------------------------------------------------------	------------------------------	---------------------------------------------------------------------------------------------

	ADAPTER TRUE1 M/F-POWERCON F	Adapter Powercon TRUE 1 M/F (NAC3FPX - NAC3MPX) to Powercon F (NAC3FCA) Code : B01442
-------------------------------------------------------------------------------------	------------------------------	---------------------------------------------------------------------------------------------



INSTALLATION CABLE AUDIO

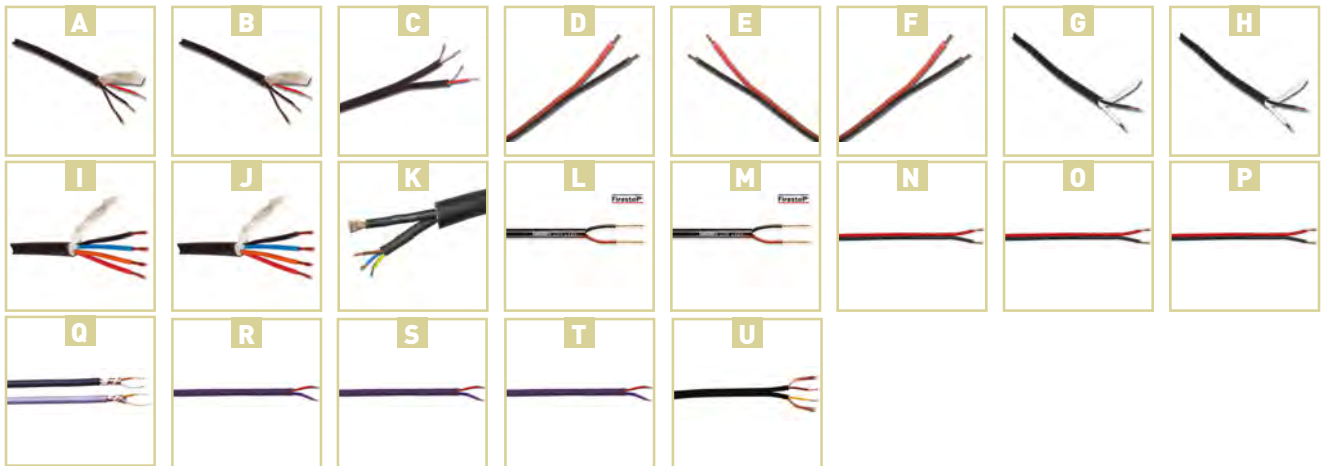

A	PROMI/20 Code : H8099	6 mm black microphone cable - 100m coil
B	PROMI/30 Code : H8100	6 mm black high quality microphone cable 100 m
C	MEP/ASY Code : H8103	Flat cable 2 x 4 mm ² asymmetrical black- 100 m coil
D	MEP-2075 Code : H8104	HP flat cable 2 x 0.75mm ² red and black - 100 m coil
E	MEP-2150 Code : H8105	HP Flat Cable 2 x 1.5 mm ² rouge et noir - bobine de 100 m
F	MEP-2200 Code : H8106	HP Flat Cable 2 x 2mm ² rouge et noir - bobine de 100 m
G	PROHP-215 Code : H8107	HP 2 x 1.5 mm cable ² black - coil 100 m
H	PROHP-225 Code : H8108	HP 2 x 2.5 mm cable ² black - coil 100 m
I	PROHP-425 Code : H8109	HP 4 x 2.5 mm cable ² black - coil 50 m
J	PROHP-440 Code : H8110	HP 4 x 4 mm cable ² black - 50 m coil
K	DUOSOUND Code : H9855	Hybrid power cable 3 x 1.5 mm ² + AUDIO - 50m

L	TAS-C275lszh Code : B01428	Low smoke/zero halogen Loudspeaker Cable 2*1
M	TAS-C276lszh Code : B01429	Low smoke/zero halogen Loudspeaker Cable 2*2
N	C102 (2x2.50 r/z) Code : B00935	Speaker cable, flat: 2x2.50mm ² , red/black
O	C102 (2x0.75 r/z) Code : B00933	Speaker cable, flat: 2x0.75mm ² , red/black
P	C102 (2x1.50 r/z) Code : B00934	Speaker cable, flat: 2x1.50mm ² , red/black
Q	C114 Black Code : B00950	Bal. mic/audio cable, round: 2x0,25mm ² , black
R	C128 Black Code : B00956	Bal. mic/audio cable, round: 2x0,35mm ² , black
S	C276 (2x2,5) Code : B00960	Speaker cable, round: 2x2.50mm ² , black, reel
T	C275 (2x1,5) Code : B00961	Speaker cable, round: 2x1.50mm ² , black, reel
U	C118 Black Code : B00963	Stereo audio cable, round: 2x0,14mm ² , black, 10

REEL



B	CAT6roll50 Code : H11048	CAT6Cable RJ45 Neutrik-50m Reel	NEUTRIK
----------	------------------------------------	---------------------------------	----------------



VIDEO CABLES



A HDMI 2M
Code : B01271 High speed HDMI cable

LIGHT CABLE

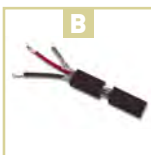
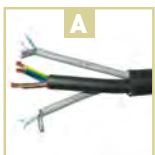

A DUOLIGHT
Code : H9854 Hybrid power cable 3 x 2.5 mm² + DMX - 50m

B DMX-DOUB
Code : H8101 DMX digital cable 2 conductors black - price per metre

C DMX-QUAD
Code : H8102 DMX digital cable 4 conductors black - price per meter

ELECTRICAL CABLE



A TIT-315
Code : H6755 Titanex cable LENS H07RNF 3 x 1.5 mm² 100m coil

B TIT-325
Code : H6756 Titanex cable LENS H07RNF 3 x 2.5 mm² 100m coil

CAT6 CABLE



A CAT6cable
Code : H11047 CAT6 flexible cable 26AWG
100m roll - Black



NEUTRIK® CONNECTORS

	NE8MC Code : H10446	Cat5e RJ45 cable plug body
	NE8FDP Code : H10447	Female socket for v5e RJ45 cable
	NC-3-FXX Code : B01102	Neutrik XLR female connector for cable, 3-pin.
	NC-3FXX Code : H8846	3-pin NEUTRIK female XLR plug
	NC-3-MXX Code : B01101	Neutrik XLR male connector for cable, 3-pin.
	NC-3MXX Code : H8848	3-pin NEUTRIK male XLR plug
	NC-3FX-HD Code : H10714	NEUTRIK 3-pole XLR female IP67 water-proof plug
	NC-3FX-HD Code : H10715	NEUTRIK 3-pole XLR male IP67 water-proof plug
	NC-5-FXX Code : B01117	Neutrik XLR female connector for cable, 5-pin
	NC-5FXX Code : H8850	5-pin NEUTRIK female XLR plug
	NC-5-MXX Code : B01118	Neutrik XLR male connector for cable, 5-pin
	NC-5MXX Code : H8851	5-pin male XLR plug NEUTRIK
	NC-3-FD-L-1 Code : B01127	Female XLR chassis, lockable, D-size, 3-pin from Neutrik.
	NC-3FDLX Code : H8852	NEUTRIK X series 3-pin female XLR socket
	NC-3-MD-L-1 Code : B01128	Male XLR chassis, lockable, [D-size], 3 pins from Neutrik.
	NC-3MDLX Code : H8853	NEUTRIK X series 3-pin male XLR socket
	NC-5-FDLX Code : B01123	Neutrik D-size 5pin XLR-f CHASSIS
	NC-5FDL1 Code : H4840	NEUTRIK D series 5-pin female XLR socket
	NC-5-MDLX Code : B01124	Neutrik D-size 5pin XLR-m CHASSIS
	NC-5MDL1 Code : H4841	NEUTRIK D series 5-pin male XLR socket
	NA-USB Code : H8854	NEUTRIK D Series USB-A socket
	NYS373-0 Code : H8855	NEUTRIK gold contact RCA plug - Black
	NYS373-2 Code : H8856	NEUTRIK gold contact RCA plug - Red
	NTP3RC Code : H7946	NEUTRIK angled stereo 3.5 JACK plug
	NP-2-X Code : B01104	Neutrik 6.3mm JACK-m mono CABLE.
	NP-2X Code : H8859	NEUTRIK male mono 6.35 JACK plug
	NP-3-X Code : B01103	Neutrik 6.3mm JACK-m stereo CABLE
	NP-3X Code : H8861	NEUTRIK male stereo 6.35 JACK plug
	NJ-3-FC-6 Code : B01106	Neutrik 6.3mm JACK-f stereo CABLE
	NJ-3FC6 Code : H4846	NEUTRIK female stereo 6.35 jack plug
	NJ-3-FP-6C Code : B01105	Neutrik D-size stereo 6.3mm JACK-f CHASSIS
	NJ-3FP6C Code : H4848	NEUTRIK D series female stereo 6.35 JACK socket

	NP2C-SILENT Code : H8857	NEUTRIK anti-plock mono jack plug
	NP2RX-SILENT Code : H8858	NEUTRIK anti-plock angled mono jack plug
	NC-3FRX Code : H8863	3-pin NEUTRIK angled female XLR plug
	NC-3MRX Code : H8865	3-pin NEUTRIK angled male XLR plug
	NP-2RX Code : H4854	NEUTRIK angled male mono 6.35 JACK plug
	NP-3RX Code : H4855	NEUTRIK angled male stereo 6.35 JACK plug
	NL-2FX Code : H4856	NEUTRIK SPEAKON plug, 2 contacts
	NL-4-FX Code : B01113	Neutrik Speakon CABLE, 4 contacts.
	NL-4FX Code : H4857	NEUTRIK X series SPEAKON plug, 4 contacts
	NL-4-MMX Code : B01116	Neutrik 2x Speakon ADAPTER, 4 contacts.
	NL-4MMX Code : H4859	NEUTRIK X series SPEAKON coupler, 4 contacts
	NL-2MP Code : H4861	NEUTRIK D series SPEAKON socket, 2 contacts
	NL-4-MP Code : B01115	Neutrik Speakon CHASSIS, D-size, 4 contacts.
	NL-4MP Code : H4862	NEUTRIK 4-way SPEAKON 2-way socket
	NL-4-MP-R Code : B01114	Neutrik Speakon BIG CHASSIS, 4 contacts.
	NL-4MPR Code : H4863	NEUTRIK SPEAKON socket, 4 contacts, EP format
	NAC3FX-W Code : H10448	Powercon True one female plug
	NAC3MX-W Code : H10449	Powercon True one male plug
	NAC3MPX Code : H10450	Powercon True one male socket
	NAC3FPX Code : H10451	Powercon True one female socket
	NAC3PX Code : B01133	PowerCON TRUE1 appliance inlet-outlet combination with 1/4" flat tab terminals.
	NAC-3-FCA Code : B01125	Neutrik PowerCon inlet (blue) CABLE
	NAC-3FCA Code : H4865	NEUTRIK 240V 20A male power input plug, 3 contacts
	NAC-3-FCB Code : B01129	Neutrik PowerCon outlet (grey) CABLE
	NAC-3FCB Code : H4866	NEUTRIK 240V 20A male power output plug, 3 contacts
	NAC-3-MPA Code : B01126	Neutrik D-size PowerCon inlet (blue) CHASSIS
	NAC-3MPA Code : H4867	NEUTRIK 240V 20A power input socket, 3 contacts
	NAC-3-MPB Code : B01130	Neutrik D-size PowerCon outlet (grey) CHASSIS
	NAC-3MPB Code : H4868	NEUTRIK 240V 20A power output socket, 3 contacts

NEUTRIK® CONNECTORS

	NF2D0 Code : H10452	RCA socket, black, D format		NC3FDLXBAG Code : B01141	X series 3-pin female XLR socket / black - NEUTRIK
	NF2D2 Code : H10453	RCA socket, red, D format		NC3MDLXBAG Code : B01140	X series 3-pin male XLR socket / black - NEUTRIK
	NA-3F5M Code : H4869	NEUTRIK DMX XLR 3 fem. / XLR 5 male adapter		NC3FXXBAG Code : B01143	3-pin female XLR plug / black - NEUTRIK
	NA-3M5F Code : H4870	NEUTRIK DMX XLR 3 male / XLR 5 female adapter		NC3MXXBAG Code : B01142	3-pin female XLR plug / black - NEUTRIK
	DBA Code : B01119	cover for Neutrik D chassis			

ELECTRICAL CONNECTORS

	CEE100 Code : H0227	CEE 22 chassis - male		CEE200 Code : H1659	CEE 22 chassis female
	CEE300 Code : H0225	CEE 22 plug - male		CEE400 Code : H0226	CEE 22 plug - female
	FIC/MAL Code : H1804	Male plastic plug 2 poles + earth		FIC/FEM Code : H1805	Female plastic plug 2 poles + earth
	FIC/CAH/MAL Code : H1806	Male rubber plug 2 poles + earth		FIC/CAH/FEM Code : H1807	Female plug 2 poles + earth
	FIC/SCHU/MAL Code : H8131	Male rubber plug IP44 schuko		FIC/SCHU/FEM Code : H8132	Female rubber plug IP44 standard French
	BT-16FS-F Code : B01406	Blue plug with IP44 cover, 230V/16A FRA/BEL			



CONNECTORS

	J35ST Code : H10876	Chrome stereo 3.5 jack plug
	J35STVIS Code : H10828	Chrome stereo 3.5 jack plug with screws
	FXF/CH Code : H2487	AUDIOPHONY XLR female plug - chrome finish
	FXF/NO Code : H7932	AUDIOPHONY X female plug - Black
	FXM/CH Code : H2488	AUDIOPHONY XLR male plug - chrome finish
	FXM/NO Code : H7933	AUDIOPHONY X male plug - Black
	XFC-103 Code : H6586	AUDIOPHONY D Series XLR female chassis
	XMC-103 Code : H6585	AUDIOPHONY D series XLR male chassis
	XMK-105 Code : H6587	5-pin male XLR plug for the AUDIOPHONY DMX
	XFK-105 Code : H6588	5-pin female XLR plug for the AUDIOPHONY DMX
	FJM/CH Code : H2495	AUDIOPHONY mono 6.35mm jack plug - chrome finish
	FJS/CH Code : H2496	AUDIOPHONY stereo 6.35mm jack plug - chrome finish
	J350/MO Code : H7936	AUDIOPHONY mono 6.35mm Jack female plug pro
	J350/STE Code : H7937	AUDIOPHONY professional stereo jack female plug - 6.35mm
	J700 Code : H7939	Stereo 6.35 mm jack female chassis with AUDIOPHONY lock
	RCA910/RO Code : H7940	Red male RCA plug for AUDIOPHONY professional cable
	RCA910/NO Code : H7941	Black male RCA plug for AUDIOPHONY professional cable
	RCA920/RO Code : H7942	Red female RCA plug for AUDIOPHONY professional cable
	RCA920/NO Code : H7943	Black female RCA plug for AUDIOPHONY professional cable

	BANA100/NO Code : H1653	AUDIOPHONY male banana plug - Black
	BANA100/RO Code : H1652	AUDIOPHONY male banana plug - Red
	BANA200/NO Code : H1655	AUDIOPHONY female banana chassis - Black
	BANA200/RO Code : H1654	AUDIOPHONY female banana chassis - Red
	BANA150/NO Code : H6595	AUDIOPHONY connector for amplifier terminal block, black
	BANA150/RO Code : H6596	AUDIOPHONY connector for amplifier terminal block, red
	BANA400/NO Code : H7944	AUDIOPHONY 2 x female banana chassis - 1 Red / 1 Black

ADAPTERS

	ADAPT400 Code : H0505	AUDIOPHONY RCA female / mono male 6.35 jack adapter		ADAPT500 Code : H0766	AUDIOPHONY female 6.35 jack / RCA male adapter
	ADAPT600 Code : H1656	AUDIOPHONY 2 RCA female / 1 RCA male adapter		ADAPT700 Code : H1657	AUDIOPHONY RCA female / RCA female adapter
	ADAPT750 Code : H7927	AUDIOPHONY 2 x RCA female / 2 RCA female adapter		ADAPT800 Code : H0767	AUDIOPHONY female 6.35 jack / female 6.35 jack adapter
	ADAPT850 Code : H0506	AUDIOPHONY 2 female 6.35 jack / 1 male 6.35 jack adapter		ADAPT900 Code : H1658	AUDIOPHONY 2 RCA female / 1 stereo male 6.35 jack adapter
	ADAPT1000 Code : H7928	AUDIOPHONY stereo female 3.5 jack / stereo male 6.35 jack adapter		ADAPT1005 Code : H7929	AUDIOPHONY stereo female 6.35 jack / stereo male 3.5 jack adapter
	ADAPT1105 Code : H7931	AUDIOPHONY stereo RCA female / stereo male 3.5 jack adapter		ADAPT1200 Code : H9278	AUDIOPHONY stereo male 6.35 jack to 2 x 3 jack adapter
	ADA/XMXM Code : H2500	AUDIOPHONY XLR male / XLR male adapter		ADA/XFXF Code : H2501	AUDIOPHONY XLR female / XLR female adapter
	ADA/XFJF Code : H2502	AUDIOPHONY XLR female / female jack adapter		ADA/XMJF Code : H2503	AUDIOPHONY XLR male / female jack adapter
	ADA/XFRM Code : H2504	AUDIOPHONY XLR female / RCA male adapter		ADA/XMRM Code : H2505	AUDIOPHONY XLR male / RCA male adapter
	ADA/XFRF Code : H2506	AUDIOPHONY XLR female / RCA female adapter		ADA/XMRF Code : H2507	AUDIOPHONY XLR male / RCA female adapter
	ADA/XFJM Code : H6560	AUDIOPHONY XLR female / mono male jack adapter		ADA/XFJMS Code : H6561	AUDIOPHONY XLR female / stereo male jack adapter
	ADA/XMJM Code : H6562	AUDIOPHONY XLR male / mono male jack adapter		ADA/XMJMS Code : H6563	AUDIOPHONY XLR male / stereo male jack adapter
	ADA/XF5XM ³ Code : H7925	AUDIOPHONY DMX XLR female 5 pins / XLR male 3 pins adapter		ADA/XM5XF3 Code : H7926	AUDIOPHONY DMX XLR male 5 pins / XLR female 3 pins adapter
	AS/SF-SF Code : H6583	AUDIOPHONY speaker extension adapter, 2 contacts		PRE-5M3F1038ZW0.15 (BAG) Code : B01423	Adaptercable XLR 3p F - XLR 5p M
	PRE-3M5F1038ZW0.15 (BAG) Code : B01422	Adaptercable XLR 3p M - XLR 5p F			























CONSTRUCTION

	POIGNSURF Code : H0279	Recessed spring surface handle
	POIGNMARCH/PM Code : H4650	Metal Marshal handle - 220 x 160 x 60 mm
	ROUE100 Code : H0288	Swivel caster diameter 100 mm
	GRENOUILLE Code : H0698	Draw bolt
	PAPILLONGM Code : H0288	Large butterfly latch
	ECROUCAGE Code : H0270	Cage nut for PROFILRACK
	VISRACK/16 Code : H0271	Cage nut screw diameter 6 mm length 16 mm
	RENFORT Code : H0290	Metal corner reinforcement
	VCA512 Code : H8882	5x12 fluted rivet (box of 100)
	V561 Code : H8880	Black flat plastic washer - 5.5 x 10mm (per 100pcs)
	CORN3020 Code : H0827	Aluminium angle 30 x 20 mm - 2 m bar
	HYBRIDE10 Code : H0284	Aluminium hybrid profile - 2 m bar
	TOLE1U-NO Code : H0736	19" panel height 1 unit
	TOLE3U-NO Code : H0738	19" panel metal height 3 units

	POIGNRENOI Code : H0280	Recessed spring return handle
	POIGNMARCH/GM Code : H4652	Marshal handle, large model - 280 x 160 x 60 mm
	ROUE100FREIN Code : H0266	Swivel caster diameter 100 mm - with brake
	PAPILLONPM Code : H0287	Medium butterfly latch
	CHARNDEG Code : H0289	Detachable metal hinge, large model
	VISRACK/12 Code : H3085	Rack screw diameter 6 mm length 12 mm
	TAMPON Code : H0273	Rubber foot, large model
	VCA412 Code : H8881	4x12 fluted rivet (box of 100)
	VCA516 Code : H8883	5x16 fluted rivet (box of 100)
	CORN2020 Code : H0283	Aluminium angle 20 x 20 mm - 2 m bar
	CORN3030 Code : H0282	Aluminium angle 30 x 30 mm - 2 m bar
	PROFILRACK Code : H0281	Sliding rack profile - 2 m bar
	TOLE2U-NO Code : H0737	19" panel height 2 units
	TOLE4U-NO Code : H0739	19" panel metal height 4 units

CONSTRUCTION

	COIN2PGM Code : H0735	2-legged metal corner - large model
	COIN3P Code : H0422	3-legged metal corner - medium model
	TOL12XLR Code : H0423	19" panel 1 unit for 6 XLR male chassis and 6 XLR female chassis
	TOLE2UV-N0 Code : H0367	19" panel, height 2 units, vented - special aeration
	JB1200 Code : B00930	JB SYSTEMS Large recessed handle for speaker
	JB6 Code : B00921	JB SYSTEMS Small recessed handle for speaker
	JB8 Code : B00932	JB SYSTEMS Plastic protection corner for speaker
	SPEAKER GRILL 10inch Code : B00910	Strong black metal grill
	SPEAKER GRILL 15inch Code : B00912	Strong black metal grid
	SPEAKER GRILL 8inch Code : B00909	Strong black metal grid
	TE20 Code : B00918	Connection plate with 2x Speakon compatible connector [®] and 2 screw connectors
	MS-00 Code : B03189	JV CASE 4x M6x16 + 4x plastic washers + 4x cage nut 2.2mm
	MS-02 Code : B03163	JV CASE 4x M6x16 + 4x plastic washers + 4x cage nut 1.5mm
	MS-04 Code : B03165	JV CASE 12x screw rack M6x16 + 12x plastic washers
	RACK DRAWER 2U Code : B03194	JV CASE 19" 2U drawer for rack
	RACK TRAY 1U Code : B03197	JV CASE 19" 1U shelf
	RP 0.5U - 1/2U Rack panel Code : B03142	JV CASE 19" panel.
	RP 1U/V - 1U ventilation rack panel Code : B03147	Vented 19" panel 1U
	RP 2U - 2U Rack panel Code : B03144	19" panel 2U
	RP 2U/V - 2U ventilation rack panel Code : B03148	Ventilated 19" panel 2U
	NEW RP 1U - 4xTRUE1 F - 5xD-size Code : B03293	U Rack panel to hold 4x Neutrik® TRUE1 F and 5x D-size connectors







	COIN3PPM Code : H0274	3-legged metal corner - small model
	COIN3PGM Code : H0734	3-legged metal corner - large model
	TOLE1UV-N0 Code : H0368	19" panel, height 1 unit, vented
	ETAGÈRE2U Code : H1626	Metal shelf height 2 units
	JB14 Code : B00926	JB SYSTEMS bass tube-Recessed bass-reflex tube for speaker
	JB7 Code : B00922	JB SYSTEMS Rubber foot for speaker
	SA65 Code : B00735	JB SYSTEMS 35mm metal adapter for speaker stands
	SPEAKER GRILL 12inch Code : B00911	Strong black metal grid
	SPEAKER GRILL 18inch Code : B00913	Strong black metal grid
	TE10 Code : B00915	Connection plate for loudspeaker with 2 terminal blocks
	A.CONTROLLER/ALU Code : B03187	Adapter for 2U/3U controllers
	MS-01 Code : B03160	JV CASE 4x M6x16 + 4x plastic washers + 4x cage nut 3mm
	MS-03 Code : B03164	JV CASE 20x black PVC washers M6
	MS-06 Code : B03178	JV CASE 12x M6 bolt x20 + 12x M6 nuts.
	MS-08 50x M4x16 bold-Mennekes Code : B03191	Set 50x M4 screws/nuts for mounting AC outlet.
	RACK DRAWER 3U Code : B03196	JV CASE 19" 3U drawer for rack
	RACK TRAY 2U Code : B03198	JV CASE 19" 2U shelf
	RP 1U - 1U Rack panel Code : B03143	19" panel 1U
	RP 1U/XLR - XLR (D-size) Code : B03149	19" panel 1U for 12 x XLR
	RP 2U/PC-8 Code : B03181	19" 2 units rack panel for 8x Blue Power Outlet
	RP 3U - 3U Rack panel Code : B03145	19" panel 3U



LOUDSPEAKERS AND FILTERS







	SRDR12 Code : H10164	1.35 inch 50W 8 Ohm driver for SR12A and SR15A
	SDR-50 Code : H9815	Driver for S8 and S10
	MOJOLINE-275 Code : H10586	2.75-inch tweeter for MOJ0500LINE
	CDR-20 Code : H10315	1-inch 20W 8 Ohm tweeter for CR80A
	JB330 Code : B00801	85x85mm piezo tweeter
	JB660 Code : B00804	161x94mm dual piezo tweeter
	PTX34 Code : B00685	HF Driver: 1.50" - 50W 8 Ohm
	SXDR-50 Code : H10853	1.35-inch driver for SX12A and SX15A speakers

	SRDR10 Code : H10163	1 inch driver for SR10A speaker
	OCDR-20 Code : H9400	COMPACT, SATCOM16, S6, D12 and D15 satellite engine
	HLTR Code : H10590	8 Ohm ribbon tweeter for HL-4
	CODR-20 Code : H10309	1-inch 20W 8 Ohm tweeter for COMPACT-500 satellite
	HT30 Code : B00806	1" capton 150W 8 Ohm bullet tweeter
	JB550 Code : B00803	187x80mm piezo tweeter
	PH2 Code : B00823	Horn for PTX34 and PTX44
	PTX44 Code : B00686	HF Driver: 1,75" - 50W 8ohm
	HT100 Code : B00807	1" capton 300W 8 Ohm bullet tweeter

	AXO-S8 Code : H9725	Filter for S8
	AXO-COMPACT Code : H9399	2-way filter for COMPACT satellite
	AXO-SR10P Code : H10320	2-way filter for SR10P speaker
	AXO-SR15P Code : H10322	2-way filter for SR15P speaker
	AXOHL Code : H10591	2-way passive filter for HL-4
	CN-3 Code : B00615	High pass filter for 2-way system [X-over freq. : 7kHz, Slope: 12dB/oct RMS power: 100W]
	CN-9 Code : B00814	2 way professional filter [X-over freq. : 2kHz, Slope: 12dB/oct, RMS power: 200W]

	AXO-S6 Code : H9724	Filter for S6
	AXO-S10 Code : H9727	Filter for S10
	AXO-SR12P Code : H10321	2-way filter for SR12P speaker
	AXO-COMPACT500 Code : H10310	2-way filter for COMPACT-500 satellite
	CN-12 Code : B00815	2-way professional filter [X-over freq. : 1.8kHz, Slope: 12dB/oct, RMS power: 300W]
	CN-6 Code : B00813	High pass filter for 2-way system [X-over freq. : 4.5kHz, Slope: 18dB/oct RMS power: 100W].

LOUDSPEAKERS

	CR25WB-200 Code : H10856	12-inch woofer for CR25A-COMBO
	SXWB15-200 Code : H10852	15-inch 250W woofer for SX15A
	iLINEw320 Code : H10765	HP 3" 20W for iLINE series columns
	SRWB12-350 Code : H10161	12" 350W 4 Ohms woofer for SR12A speaker
	SRWB12-350-8 Code : H10318	12-inch 350W 8 Ohm woofer for SR12P
	SW8-150 Code : H9816	8-inch woofer for S8
	OWB6-100 Code : H9401	6.5" 8 Ohms 100 W woofer for COMPACT and S6 satellites
	CRW6-60 Code : H10314	6.5-inch 80W 8 Ohm woofer for CR80A
	OWB12-400-8 Code : H9402	12-inch 400W 8 Ohm woofer for COMPACT subwoofer
	HLWB10 Code : H10589	10-inch 8 Ohm woofer for HL-10ASUB
	HLWB8 Code : H10588	8-inch 8 Ohm woofer for HL-08ASUB
	CUBW12-300 Code : H10728	12-inch 300W woofer for CUBsub112
	SRWB18-600 Code : H10733	18-inch woofer for SRSUB18A
	COW4-60 Code : H10308	4.75-inch 80W 8 Ohm woofer for COMPACT-500 satellite
	PWX 18/400 Code : B00683	18-inch / 400Wrms woofer
	SP-12/200 Code : B00666	12-inch / 200W woofer
	SXWB12-200 Code : H10851	12-inch 200W woofer for SX12A
	SRWB10-250 Code : H10160	10-inch 250W 4 Ohm woofer for SR10A speaker
	SRWB15-350 Code : H10162	15" 350W 4 Ohms woofer for SR15A speaker
	SRWB15-350-8 Code : H10319	15-inch 350W 8 Ohm woofer for SR15P
	SRWB10-250-8 Code : H10317	10 inch woofer 250W 8 Ohms for SR10P
	SW10-250 Code : H9726	10-inch woofer for S10
	OWB15-600 Code : H9106	15" woofer used in OCTAVE, SUB115-AMP, EX15S, EX215S subwoofers
	HLWB4 Code : H10587	4-inch 8 Ohms woofer for HL-4
	MOJOLINE-08 Code : H10585	8-inch woofer for MOJ0500LINE
	CUBW08-150 Code : H10729	8-inch 150W woofer for CUBsub208
	COWB10-300 Code : H10307	10-inch 300W 4 Ohm woofer for COMPACT-500 subwoofer
	PWX 10/200 Code : B00679	10-inch / 200Wrms woofer
	SRWB15-500 Code : H10352	15-inch woofer for SRSUB15A
	PWX 15/300 Code : B00681	15-inch / 300Wrms woofer
	SP-10/150 Code : B00665	10-inch / 150W woofer
	SP-15/250 Code : B00667	15-inch / 250W woofer



LAMPS

	LPAR36/4515 Code : H0132	GE lamp PAR36 6V 30W 4515
	LPAR56/WFL Code : H8662	GE lamp PAR56 240V 300W 37° x 20°
	MASTER LEDspot PAR20 DIM Code : B06501	PHILIPS LED LAMP 6W--2700K- E27-25°-DIM
	MASTER LEDspot PAR38 DIM Code : B06503	PHILIPS LED LAMP 13W-2700K- E27-25°-DIM
	GY9.5500 Code : H0296	Philips lamp CP82 240V 500W
	GX9.51000 Code : H0295	Lamp CP70 240V 1000W
	LR75/118-500 Code : H9011	Lamp R7S 240V 500W 2900°K 2000H
	NEW SIRIUS HRI 100W Code : B02180	Metahalogen Lamp, 100 Watt, 6000h, 9000K
	LMSD-250/2 Code : H8994	Lamp type MSD-250-2 94V 250W 8000°K 2000H
	LBVM1 Code : H9006	Lamp type BVM 120V 300W 3200°K 150H
	LBVM3 Code : H9007	Lamp type BVM 240V 300W 3200°K 75H
	G6.3540036 Code : H0626	Osram lamp EVD 36V 400W
	LEFR Code : H9009	Lamp type EFR 15V 150W 3400°K 50H
	ELC25024 Code : H3119	Philips lamp ELC 24V 250W
	ENH250120 Code : H0177	Osram lamp ENH 120V 250W

	LPAR56/MFL Code : H0131	GE lamp PAR56 240V 300W
	MASTER LEDspot PAR16 DIM Code : B06500	PHILIPS LED LAMP 3.7W-2700K-GU10-25°-DIM
	MASTER LEDspot PAR30 DIM Code : B06502	PHILIPS LED LAMP 9.5W-2700K-E27-25°-DIM
	GY9.5650 Code : H0297	GE lamp T26 240V 650W
	GX9.51000/T19 Code : H2590	Lamp T19 240V 1000W
	HPL 575-X LL 230v Code : B02171	GE Lighting Halogen lamp, no reflector, 575W/230V, sp. socket
	L2R Code : H10165	Philips® MSD Platinum 2R lamp
	L15R Code : H10358	Philips MSD Platinum 15R lamp
	MSD250/2-0S Code : H3425	Osram lamp MSD 250W
	G6.35300110 Code : H1247	Osram lamp 64514 120V 300W
	G6.35300220 Code : H0628	Osram lamp 64516 240V 300W
	EFP10012 Code : H0624	Philips or Osram lamp EFP 12V 100W
	LELC Code : H9008	Lamp type ELC 24V 250W 3200°K 50H
	LELC/LD Code : H8986	lamp type ELC 24V 250W 3200 °K 300H
	LST/1500 Code : H9021	Lamp strobe type-3 1500W 5600°K 500H 120Hz max



WWW.SYNQ-AUDIO.COM



WWW.AUDIOPHONY.COM



WWW.AUDIOPHONY-PA.COM



WWW.BRITEQ-LIGHTING.COM



WWW.CONTEST-LIGHTING.COM



WWW.CONTEST-LIGHTING.COM



WWW.JB-SYSTEMS.EU



WWW.HILEC.EU



The advertised prices are VAT-inclusive prices, calculated with the VAT in force in the country of distribution.

See conditions at your retailer. Within the limits of available stocks. Information is subject to typographical errors. The technical specifications, photos, illustrations and prices in this catalogue are not binding. In order to improve our products, modifications can be made. In accordance with the legislation in force, it is up to each retailer to freely set its selling prices. Prices are subject to change without notice. The prices invoiced, in particular, are those of the tariff in force on the day of delivery. Catalogue in effect as of March 16, 2020.

AUDIOPHONY®, AUDIOPHONY-PA®, CONTEST®, CONTESTAGE®, JB SYSTEMS®, BRITEQ®, SYNQ®, HILEC® & JVCASE® are registered trademarks of HITMUSIC SAS and BEGLEC NV.

Any reproduction of the catalogue, even partial, or use of the logos or design of the intellectual property is prohibited, without prior written permission from HIT MUSIC SAS and/or BEGLEC NV.

Catalogue published by HIT MUSIC SAS - Parc d'Activités CAHORS SUD - EN TESTE
46230 FONTANES - France.

Product photo credits : Studio ZE and BEGLEC NV. - Ambience photo credits : © Shutterstock -
Creation: Agence NOVO & HITMUSIC SAS

MKT-CATA2020
ANG / AVEC PRIX



3 662009 019499

code H10891