

SMA & SMQ

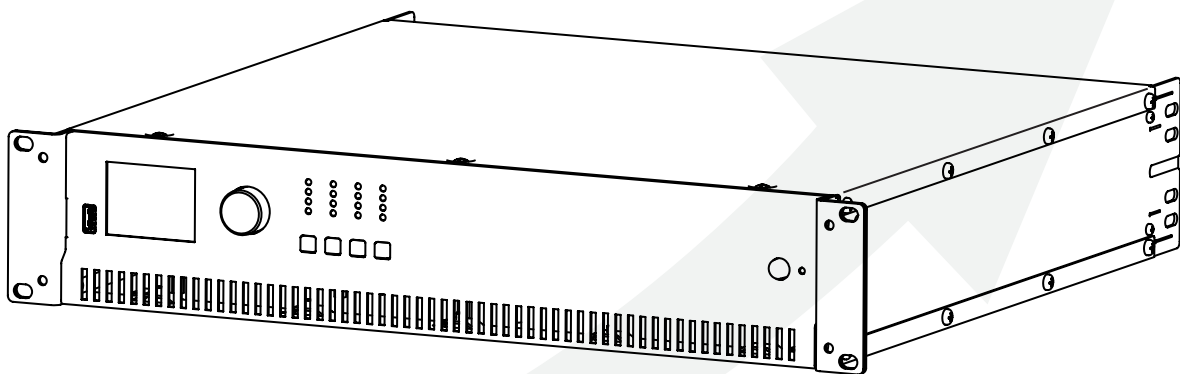

ADDITIONAL INFORMATION

This manual is put together with much care, and is as complete as could be on the publication date. However, updates on the specifications, functionality or software may have occurred since publication. To obtain the latest version of both manual and software, please visit the Audac website @ www.audac.eu.

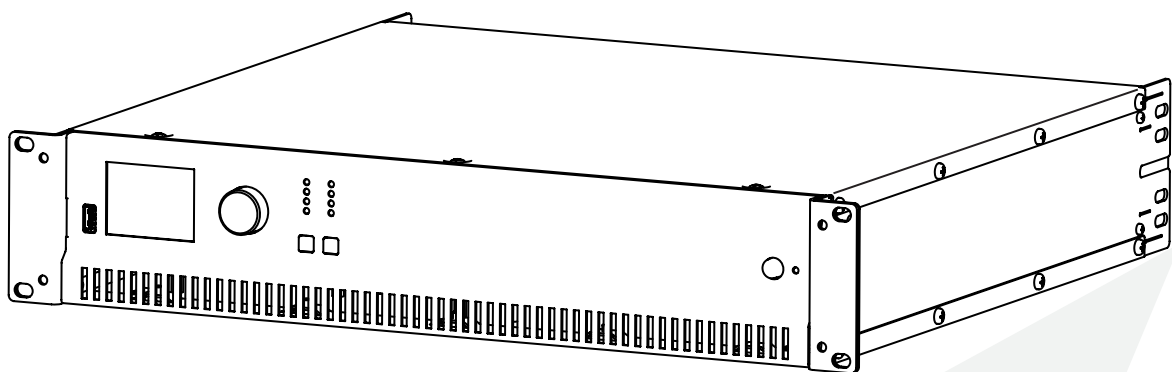

Table of contents



Introduction	04
WaveDynamics™ Class D power amplifiers	04
Precautions	06
Chapter 1	08
Connections and connectors	08
Chapter 2	010
Overview SMA & SMQ	010
Chapter 3	013
Quick start guide	013
Connecting the amplifier	013
Configuring the amplifier	013
Ready	014
Chapter 4	015
Connecting the amplifier	015
Input connections	015
Output connections	016
Connection examples	016
Wire up the system	018
Chapter 5	019
Configuring the amplifier	019
Main screen	020
Settings menu	020
Level	020
Input	020
Mute	021
Output setup	021
Output setup >> Input list	021
Output setup >> Filters	021
Output setup >> Equalizing	022
Output setup >> Delay	022
Output setup >> Max level	023
Output setup >> Standby	023
Output setup >> Limiter	023
Output setup >> Phase reverse	023
Output setup >> Dynamic bass	023
Output setup >> Bridge	024
Output setup >> SPKR preset	024
General setup	024
General setup >> Input gain	025
General setup >> TouchLink	025
General setup >> Address	025
General setup >> Passwords	025
General setup >> Admin PIN	026
General setup >> User PIN	026
General setup >> LCD	026
General setup >> USB	026
General setup >> Info	028
General setup >> Temperature	028
General setup >> Factory reset	028
Lock	028
Technical specifications	029

WaveDynamics™ Class D power amplifiers

The SMA & SMQ series are Class D Power Amplifiers featuring WaveDynamics™ audio processing technology. They come in different output configurations with two or four channels and are available in output powers of 350 Watt, 500 Watt, 750 Watt and 1250 Watt. Their great flexibility and different configurations make it the solution for nearly every system, no matter if it's a fixed installation or a mobile application.



Speaker Presets

WaveDynamics™

A complete library of AUDAC loudspeaker and set solution presets is available for your projects, making it easy as picking the right file, loading it & play! Besides the optimal acoustic configurations, this library also includes the loudspeaker performance parameters providing a bulletproof protection for them.



7-Band EQ

The 7-band fully parametric equalizer with adjustable frequency and Q factor and Butterworth, Bessel and Linkwitz-Riley filters with selectable roll-off allow you to create custom configurations, tweak your setup to the finest detail and adapt to your rooms acoustics. A delay function allows time alignment of different speakers in your installation.



Digital Audio Filters

Configurations also allow you too bridge the outputs, doubling the output power of stereo channels to one mono channel. With a SMQ it is also possible to create a single three-channel amplifier driving a complete setup composed of stereo mid/high frequency speakers and a bass cabinet.



Time Alignment

Controllability

The operation and configuration of the device can be done in multiple ways. The most obvious way is by using the front panel controls, featuring a rotary selection dial and channel selection buttons with a clear and intuitive user interface on the 2.5" graphical LCD Display.

Total system configurations for pre-defined set solutions can be loaded into the amplifier using the USB port.



Dynamic Bass

Integration of the audio system into home automation and industrial automation systems is made easy by the RS-232 connection & control port, allowing functions such as input switching, volume control, ...

There is the possibility to control the unit remotely thanks to the AUDAC Touch™ app. The optional ANI44XT must be installed to control the unit via the AUDAC Touch™2 app.



Input Matrix

Flexibility

Every system comes with different requirements and every customer has his own preferences. Because of this, the structure is made as flexible as possible.

This is achieved by an input selection matrix. Each of the input connections can be patched to any amplifier channel and contains software controllable gain. The different implementations of the in- and output connectors allow the easiest way of connection for every application, while allowing signal link through to other amplifiers.



Protection

Optimal protection is not only required for the listeners satisfaction, but can also be important for complying to the imposed regulations and guaranteeing the lifetime of the equipment. Because of this, protection precautions are implemented in different ways.



Firstly, user access is made possible on different levels. The device can be blocked or accessed in user or administrator level. Different levels allow different configuration and control functions, giving limited (Eg: only volume) control access to standard users and full configuration control to administrators. User restriction can be enabled & disabled and is given through password and / or USB-key.



Secondly, equipment protection is implemented by an output limiter which monitors the output power of every channel and will intervene when the output exceeds a certain level. The corresponding level can be software configured and is indicated in Watts. When the output limiter is configured at the maximum power of the loudspeaker, you can rest assured that the speakers won't be blown during your absence.

Lastly, the maximum volume for every channel can be set independently. This prevents users (having volume access) going over the limit. This can help you to keep the system compliant with imposed regulations and maintain a good relationship with the neighbors.



Efficiency

The switching mode power supply and Class D Amplifier technology in combination with the configurable auto-standby mode for each separate amplifier channel brings an end to the era of the power-hungry amplifiers. In addition, these features also result in a lightweight amplifier which benefits the customer when used in mobile applications.

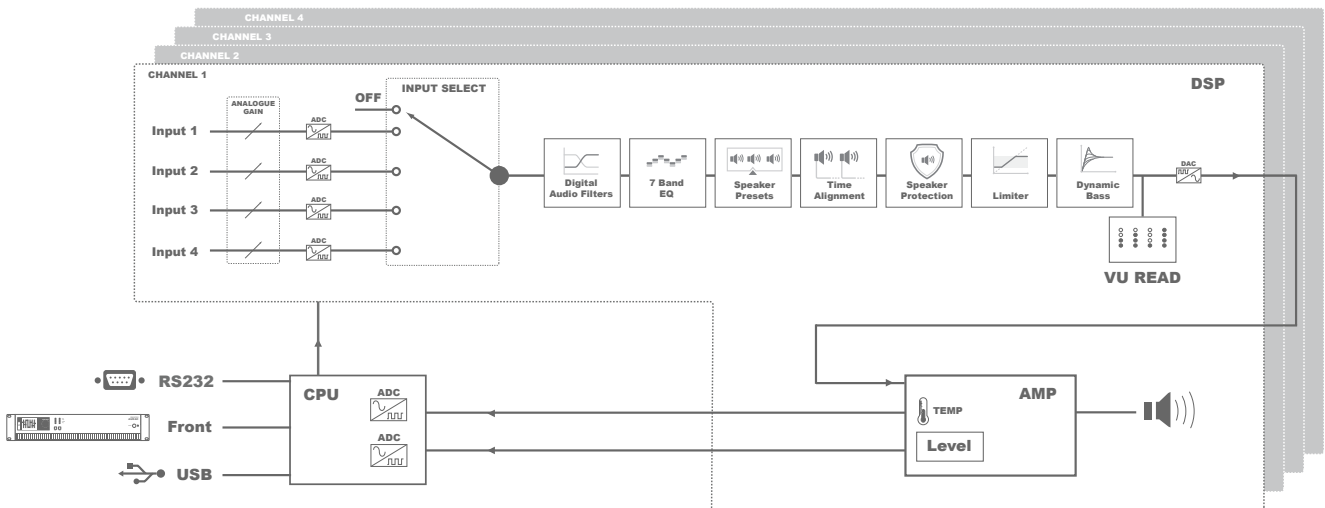

Precautions



READ FOLLOWING INSTRUCTIONS FOR YOUR OWN SAFETY

ALWAYS KEEP THESE INSTRUCTIONS. NEVER THROW THEM AWAY

ALWAYS HANDLE THIS UNIT WITH CARE

HEED ALL WARNINGS

FOLLOW ALL INSTRUCTIONS

NEVER EXPOSE THIS EQUIPMENT TO RAIN, MOISTURE, ANY DRIPPING OR SPLASHING LIQUID. AND NEVER PLACE AN OBJECT FILLED WITH LIQUID ON TOP OF THIS DEVICE

NO NAKED FLAME SOURCES, SUCH AS LIGHTED CANDLES, SHOULD BE PLACED ON THE APPARATUS

DO NOT PLACE THIS UNIT IN AN ENCLOSED ENVIRONMENT SUCH AS A BOOKSHELF OR CLOSET. ENSURE THERE IS ADEQUATE VENTILATION TO COOL THE UNIT. DO NOT BLOCK THE VENTILATION OPENINGS.

DO NOT STICK ANY OBJECTS THROUGH THE VENTILATION OPENINGS.

DO NOT INSTALL THIS UNIT NEAR ANY HEAT SOURCES SUCH AS RADIATORS OR OTHER APPARATUS THAT PRODUCE HEAT

DO NOT PLACE THIS UNIT IN ENVIRONMENTS WHICH CONTAIN HIGH LEVELS OF DUST, HEAT, MOISTURE OR VIBRATION

THIS UNIT IS DEVELOPED FOR INDOOR USE ONLY. DO NOT USE IT OUTDOORS

PLACE THE UNIT ON A STABLE BASE OR MOUNT IT IN A STABLE RACK

ONLY USE ATTACHMENTS & ACCESSORIES SPECIFIED BY THE MANUFACTURER

UNPLUG THIS APPARATUS DURING LIGHTNING STORMS OR WHEN UNUSED FOR LONG PERIODS OF TIME

ONLY CONNECT THIS UNIT TO A MAINS SOCKET OUTLET WITH PROTECTIVE EARTHING CONNECTION

THE MAINS PLUG OR APPLIANCE COUPLER IS USED AS THE DISCONNECT DEVICE, SO THE DISCONNECT DEVICE SHALL BE READILY OPERABLE

USE THE APPARATUS ONLY IN MODERATE CLIMATES

CAUTION

The symbols shown are internationally recognized symbols that warn about potential hazards of electrical products. The lightning flash with arrow point in an equilateral triangle means that the unit contains dangerous voltages. The exclamation point in an equilateral triangle indicates that it is necessary for the user to refer to the users manual.



These symbols warn that there are no user serviceable parts inside the unit. Do not open the unit. Do not attempt to service the unit yourself. Refer all servicing to qualified personnel. Opening the chassis for any reason will void the manufacturer's warranty. Do not get the unit wet. If liquid is spilled on the unit, shut it off immediately and take it to a dealer for service. Disconnect the unit during storms to prevent damage.



CAUTION - SERVICING

This product contains no user serviceable parts. Refer all servicing to qualified service personnel. Do not perform any servicing (unless you are qualified to)



EC DECLARATION OF CONFORMITY

This product conforms to all the essential requirements and further relevant specifications described in following directives: 2014/30/EU (EMC) & 2014/35/EU (LVD).



WASTE ELECTRICAL AND ELECTRONIC EQUIPMENT (WEEE)

The WEEE marking indicates that this product should not be disposed with regular household waste at the end of its life cycle. This regulation is created to prevent any possible harm to the environment or human health.

This product is developed and manufactured with high quality materials and components which can be recycled and/or reused. Please dispose this product at your local collection point or recycling centre for electrical and electronic waste. This will make sure that it will be recycled in an environmentally friendly manner, and will help to protect the environment in which we all live.

POWER SUPPLY AND POWER CORD REQUIREMENTS

Power supply class I grounding requirements:

For protection from fault currents, the equipment shall be connected to a grounding terminal. Plug the system power cord into an AC outlet that provides a ground connection. Substitute cords may not provide adequate fault protection. Only use the power cord supplied with this product or an authorized/equivalent replacement

SAFETY NOTICES:

DENMARK:Apparatets stikprop skal tilsluttes en stikkontakt med jord, som giver forbindelse til stikproppens jord.

FINLAND:Laite on liitettävä suojakoskettimilla varustettuun pistorasiaan.

NORWAY:Apparatet må tilkoples jordet stikkontakt.

SWEDEN:Apparaten skall anslutas till jordat uttag.

ATTENTION

The fuse provides a safeguard function to the device. When replacing the fuse, make sure that the value of the replacement matches the value of the original fuse. Identification of a suitable replacement component or substitute shall be done by qualified technicians.

Connections and connectors

CONNECTION STANDARDS

The in- and output connections for AUDAC audio equipment are performed according to international wiring standards for professional audio equipment

XLR

For balanced line input connections

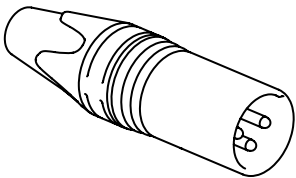

PIN 1: Ground
PIN 2: Signal +
PIN 3: Signal -

3-Pin Terminal block:

For balanced in and output connections

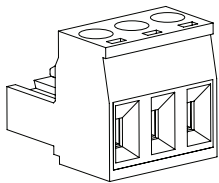

Left: Signal -
Center: Signal +
Right: Ground

For balanced line input connections

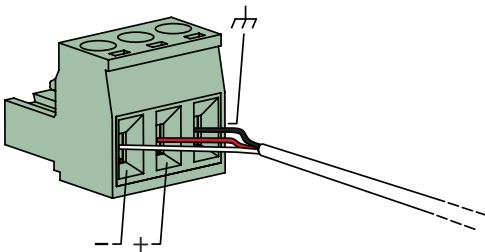

For unbalanced line in connections:

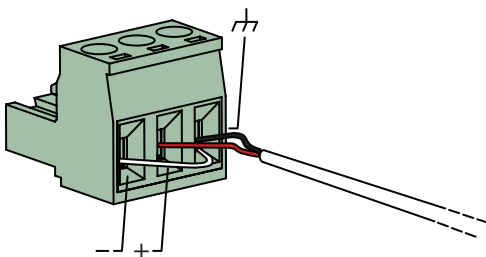

RS232 (serial connection interface):

For connection with home automation systems, or other remote control equipment

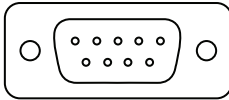

Connection	Standard RS232
PIN 2	SMAQ TX
PIN 3	SMAQ RX
PIN 5	GND
Settings	19200 Baud
	8 Bit
	1 Stop bit
	No parity
	No Handshaking

Overview SMA & SMQ

Front panel

SMA Series

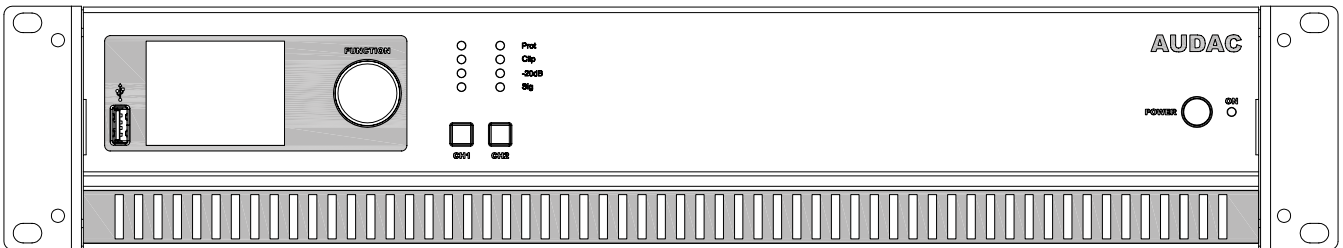

SMQ Series

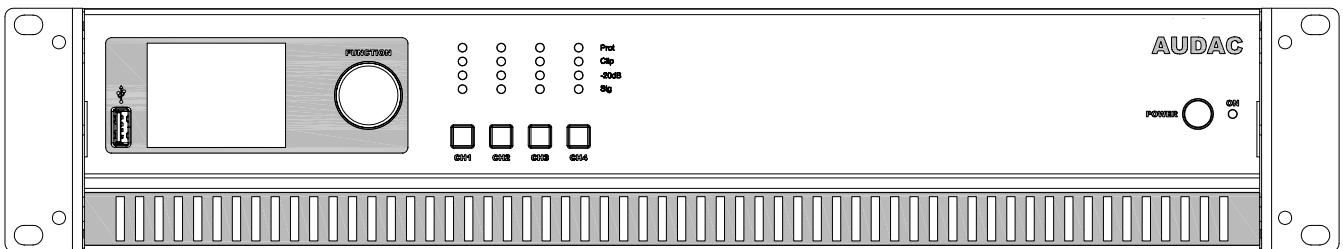

Front panel description

The front panel of all SMA/SMQ amplifiers is almost identical, with few minor differences between the different models. The SMA series amplifiers (2-channel versions) only have two output selection buttons, while the SMQ series amplifiers (4-channel versions) have four. Other provided features such as USB port, LCD display and rotary selection dial are identical for all models.

USB port

A USB port is provided on the left side of the front panel. This is meant for inserting flash drives with configuration files to load into the amplifier or duplicating system configuration files to the inserted medium. The inserted flash drive shall support FAT32 filesystem.

Graphical LCD display

A clear system overview and intuitive user interface is provided on the 2.5" graphical LCD display. This true colour display provides a clear overview of the amplifiers operation mode guaranteeing a user friendly experience when browsing through the menu structure.

Rotary selection dial

Browsing through the menu structure and adjusting parameters is made easy with the rotary selection dial. This multifunctional rotatable dial allows easy one-hand operation throughout the entire menu structure. Browsing can be done by turning it while actions will be taken when pressing it.

Channel selection buttons with indicator LED's

Channel selection and monitoring is made easy through a selection button together with four indicator LED's for every channel. When pressing the button, the menu structure will call the settings of the corresponding channel, allowing adjustment of the parameters.

The LED's give a continuous indication of the operation of the corresponding channel. The green Signal LED illuminates whenever a signal is present, while the -20dB LED illuminates when the input signal exceeds the -20 dBu level. The Clip LED illuminates when the corresponding channel is working at maximum level. To ensure the best signal-to-noise ratio, the Clip LED may only illuminate at peak levels.

When the Clip LED illuminates, the output limiter of the amplifier will intervene avoiding a distorted "Clipping" sound on the output. The Protection LED will illuminate when overheating occurs, or any other fault is detected. When the protection LED is illuminated, no signal will be available on the outputs.

When the volume for multiple outputs should change simultaneously, press and hold their channel selection buttons for about 3 seconds. The desired channels will be simultaneously selected and volume change will apply to all selected channels.

Power switch

A power switch is used to switch the amplifier on and off, while the blue indicator LED located next to the button illuminates when the power is switched on.

Rear panel overview

SMA Series

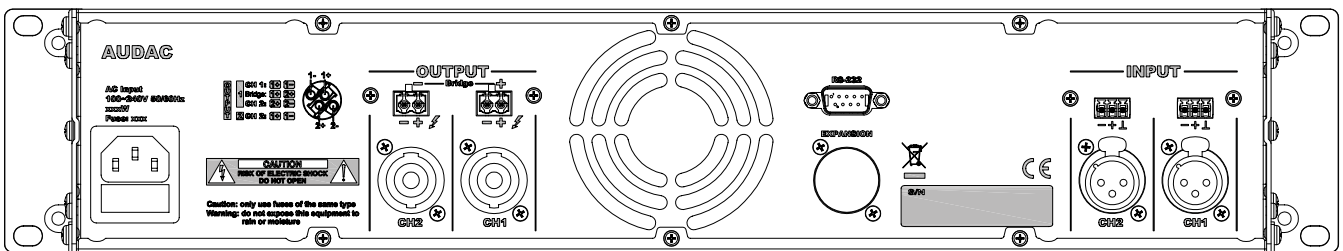

SMQ Series

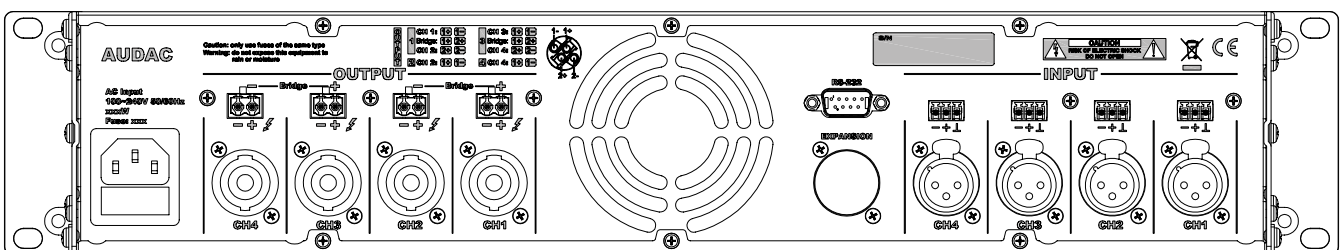

Rear panel description

The rear panel of all SMA/SMQ amplifiers is almost identical, with few minor differences between the different models. The SMA series amplifiers (2-channel versions) have two inputs and two outputs, while the SMQ series amplifiers (4-channel versions) have four. Other provided connectivities such as RS-232 and power are identical for all models.

AC Power inlet with fuse

The mains power supply (230~240 V AC / 50 Hz or when the voltage selector is switched 100~120V AC / 60 Hz (NOT implanted in SMQ1250)) has to be applied to this AC power inlet. The connection is made by an IEC power connector and is fitted with a fuse. When replacing the fuse, make sure that the value of the replacement fuse matches the value of the original fuse. (SMA350: T6.3AH/250V - SMA500: T8AH/250V - SMA750: T12AH/250V - SMQ350: T8AH/250V - SMQ500: T12AH/250V - SMQ750: T16AH/250V - SMQ1250: T16AH/250V)

Loudspeaker output connections

The loudspeaker output connections are implemented in two ways, using speaker output connectors and terminal block output connectors. This way, connections can always be made in the most simple way for every application.

A detailed description for connecting loudspeakers in the most appropriate way for each application can be found in the next chapter 'Connecting the amplifier'.

Signal input connections

Signal input connectors are implemented in two ways, using balanced XLR and 3-pin terminal block connectors. This way, connections coming from the signal source such as pre-amplifier, mixer or matrix system can always be made in the most easy and appropriate way while allowing signal linkthrough to other amplifiers.

RS232 Connection

The amplifier can be controlled through external hardware such as home & industrial automation systems by linking it to the RS-232 connection. The pinout and communication settings are described in an earlier chapter of this user manual.

The complete RS-232 command instruction set and configuration information can be downloaded from the AUDAC website.

Optional expansion port

Installation of optional modules is possible with the optional expansion slot. In standard configuration this D-size hole is covered with a blind plate which needs to be removed before installing the module.

AUDAC provides the possibility to extend the device with a Dante™ audio network interface. The optional expansion module ANI44XT can be installed quickly and easily. More information on available modules and how to install them can be found on the AUDAC website.

Quick start guide

Connecting the amplifier

ATTENTION

Make sure the power of the device is turned OFF before any connections or wiring adjustments are made. Disregarding this rule can lead to permanent damage of the equipment.

1) Connecting audio inputs

Connect all the audio sources to the input connections on the rear side of the amplifier. Depending on the installation and the used sources (pre-amplifiers, mixers, matrix systems, ...) the appropriate selection of input connectors can be made between XLR and terminal block.

2) Connecting loudspeakers

Connect loudspeakers to the outputs of the amplifier. Depending on the application and the connected loudspeakers, the appropriate selection of loudspeaker connections can be made between speaker and terminal block. In most standard applications, loudspeakers will be connected to the +1 / -1 terminals of the speaker connector (or + / - terminals of terminal block connector). Depending if any channels should be connected in bridge, corresponding connections should be made as indicated on the rear panel.

3) Other connections

After the in- and output connections are made, other connections such as mains power (and RS-232 if required) can be made. After connecting them, the amplifier is ready to be powered-up and configured.

Configuring the amplifier

1) Configuration using presets

In case your setup is a pre-defined set solution from AUDAC, a set solution configuration file will be available (*.SOL) whereby all settings for the configuration can be made by uploading the corresponding file to the amplifier. In this case, the preset file should be downloaded from audac.eu. As next, the file should be stored on an USB storage device and inserted to the USB port on front of the amplifier. After inserted the USB storage device, browse to the 'Settings' > 'General setup' > 'USB' > 'Load', browse to the correct file and press the function dial. After selected, all settings for the set solution will be loaded in one action, and all other configuration steps can be skipped. In case a custom configuration is required, proceed to the next step.

2) Configuring the outputs

The first step when a custom configuration is required is configuring the output channels. In standard configuration, every output channel is functioning independently. In case this configuration is required for your setup, this step can be skipped. When your setup requires one (or more) bridged output channels, channel bridging settings can be made by selecting the corresponding output and browse to the 'Settings' > 'Output setup' > 'Bridge' menu. When the bridge function is switched on, two channels will be merged to one output channel doubling the output power. On the main screen, only one fader will be displayed for a bridged channel.

NOTE: For further information about connecting the outputs in bridge mode, see page 17 of this manual.

3) Configuring the inputs

After the output configuration has been made, the next step is the input configuration. In standard configuration, every output channel is patched with the corresponding input channel (Input 1 to Output 1, ...). In case this configuration is required for your setup, this step can be skipped. In cases where specific inputs should be assigned to the outputs, the input selection can be made in the settings menu under 'Settings' > 'Input'. Selection is possible between all applied inputs, including summed inputs (Converting stereo inputs to mono).

After the inputs are assigned to the outputs, the input gain for every used input should be set. The input gain can be adjusted under 'Settings' > 'General setup' > 'Input gain'. On the right side of this screen are colour indicators shown for every input, giving feedback of the currently set gain. A correct regulation of the input gain is achieved when the green indicator is frequently blinking, the orange indicator is only illuminated at the peaks (-6 dB) and the red indicator blinks rarely or not. When the red indicator blinks frequently, the input is overdriven and the gain needs to be reduced. When the green indicator blinks rarely or not, no input signal is detected and the gain needs to be increased.

4) Acoustics configuration

After the in and output configurations have been made, the next step is making acoustic configurations and optimizations. When bass cabinets are used in the installation, it might be required to add low-pass filters to the bass cabinets channel, and high-pass filters to the mid/high loudspeakers channels. Filter configurations can be made in the 'Setup' > 'Output configuration' > 'Filters' menu. Sound quality can be optimized to specific acoustics using a 7-band equalizer which can be found in the same menu. Besides, other specific configurations such as limiting can be made in the same menu.

Ready

After all above connections and configurations have been made, the system is ready for rock & roll. More specific features such as password protection, standby mode, and many more can be configured. How this should be done can be found in further chapters of this instruction manual.

Connecting the amplifier

NOTE

Make sure the power is switched OFF when any change is made to the connections of the amplifier.

Input connections

The signal input connections are performed using a balanced XLR and 3-pin terminal block (3.81 mm pitch) connector for every input. Both connectors are linked in parallel, allowing free selection to which connector the signal will be applied. If required, the second connector can be used for link-through of the applied signal to other amplifiers.

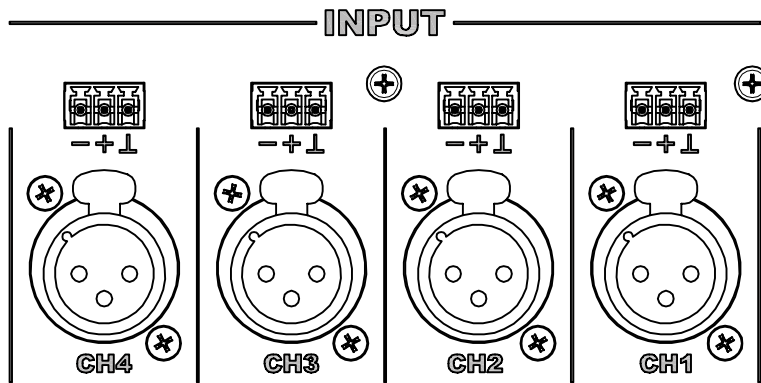

The input structure of the amplifier is made flexible due to the input selection matrix, meaning that any signal applied to the amplifier can be patched to any output channel. When driving multiple channels with the same signal or summing stereo signals into a single mono signal (Eg. when the amplifier is being used in bridged mode), external links are redundant due to the input matrix.

Selecting and assigning the input signals to the amplifier channels is made easy with the software configurable user interface which is controllable using the front panel controls.

Output connections

The loudspeaker output connections are performed using a speakon and 2-pin terminal block (5.08 mm pitch) connector for every output. Both connectors are linked in parallel, allowing free selection and the most suitable connection for every application.

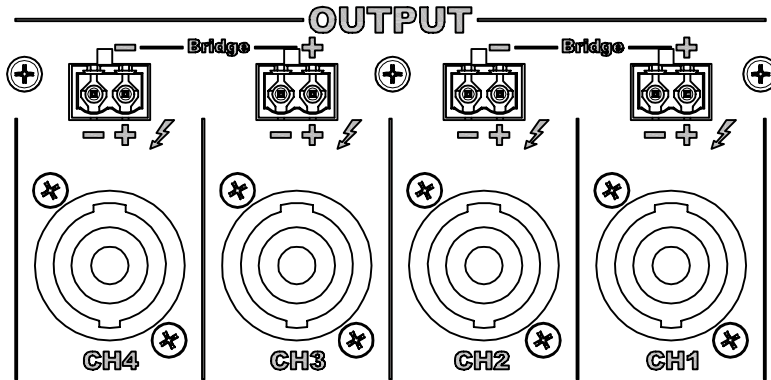

The used speakon connectors are 4-pole types, containing the output signal for the corresponding channel on +1/-1 terminals. The speakon connector for the first (and third for SMQ) channel also contains the output signal for the subsequent channel on +2/-2 terminals. This allows to transfer of two amplifier channels over one four-conductor loudspeaker cable which is fitted with one connector. Connection in bridge mode can also be made using one single connector



Connection examples

Normal operation mode:

This is the most common mode whereby every channel is driven with a separate signal and a loudspeaker is connected to each of them. The loudspeakers are connected using a two-core loudspeaker cable (or one four-core loudspeaker cable for two subsequent channels) to the corresponding terminals (+1/-1 for speaker connectors and +/- for terminal block connectors).

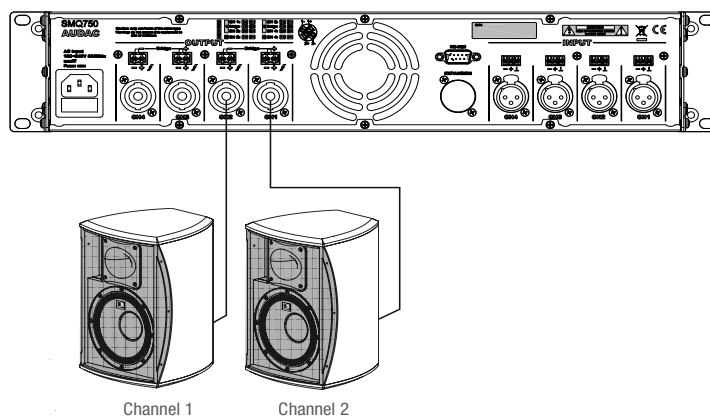

Bridged mono mode

In bridged mono mode, one single load is connected between two amplifier outputs, merging both of them which results in double output power to one single load. In this configuration, the load is connected using a two-core loudspeaker cable between the + terminals of both channels. When using speaker connectors, connections are made between +1 and +2 terminals of the channel 1 (or channel 3 for SMQ). When using terminal blocks, connections are made between both + terminals.

Selection for bridged output channels is made through software configuration by the user interface which is controllable using the front panel controls.

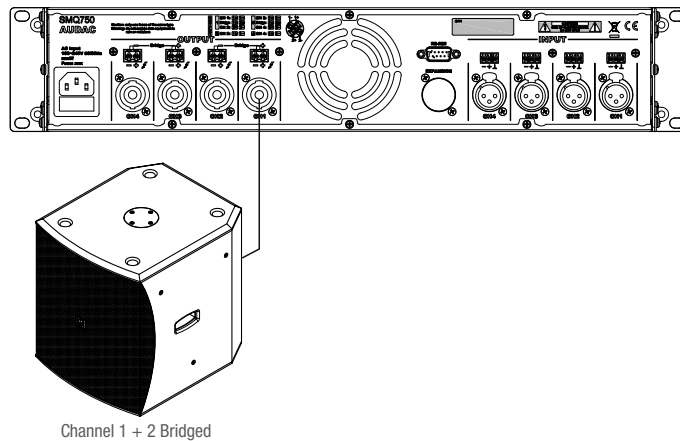

Three channel configuration (Only SMQ):

In three channel configuration, two outputs are used in normal operation mode and both other outputs are switched in bridged mode while feeding the amplifier with a stereo input signal. This configuration is commonly used when two mid/high frequency loudspeakers are supplemented with an additional (mono) bass cabinet for the low frequencies. The mid/high frequency loudspeakers are connected as described in normal operation mode, while the bass cabinet is connected as described in bridged mono mode.

Besides the selection for the bridged amplifier channel, further advanced settings such as filtering is usually configured for this kind of setups. All these settings can be configured by the user interface which is controllable using the front panel controls.

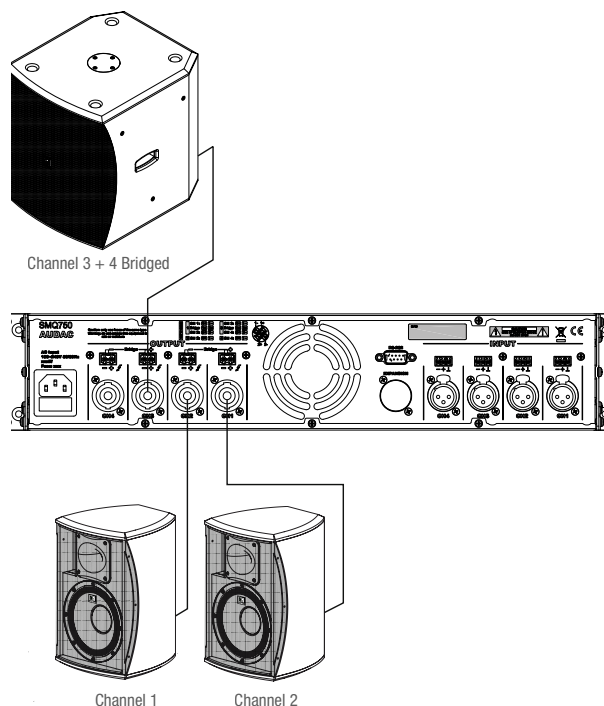

ATTENTION

Do not connect any conventional 100 Volt line transformers directly to the loudspeaker outputs, an integrated decoupling network shall be provided when used in combination with line transformers.

Wire up the system

The wiring of the system must be done according to the following rules, to guarantee a proper functioning of the system in all circumstances.

1. Speaker cable for amplified outputs:
 - Minimum 2 x 1,5 mm₂
 - If distance > 15 m: 2 x 2,5 mm₂

2. Music sources and zone outputs:
 - Must be connected with high-quality audio cable and high-quality connectors

Main screen

The main screen gives a fader overview for the output channels of the amplifier. Depending the channels for the corresponding model (two for SMA or four for SMQ), the output level for each channel can be adjusted.

Above each of the faders, the names of the output channels are shown (OUT 1, OUT 2, ...). Right under that, the name of the inputs (INPUT 1, INPUT 2, ...) linked with these outputs are indicated. And below the input, the level of the output channel is displayed.

The selection of the corresponding channel can be made using the 'Channel selection buttons' which are located below the VU meters of every channel on the front panel of the amplifier. The output level for the currently operated channel is indicated in green and can be adjusted by turning the rotary function dial in clockwise (up) and counter-clockwise (down) direction. The fader will slide up or down when the output level is adjusted. The output level can be adjusted from -70dB up to 0dB..

On the bottom of the main screen, a mute indicator is shown for every channel. This indicator will be indicated in green when the channel is playing and turns red when muted.

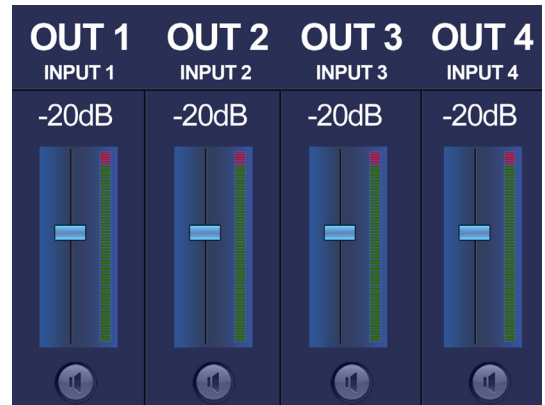

Settings menu

The settings menu of the selected output (selected using the channel selection buttons) can be opened by pressing the rotary function dial, while in the main menu. This menu, which is only accessible in administrator mode (will be described extensively in a later section of this user manual), allows the user to make adjustments to the channel setup and general setup.

Scrolling through this menu is possible by turning the rotary function dial clockwise (next option down) and counter-clockwise (next option up). The currently selected option will be highlighted and the related settings will be shown on the right side of the screen. Interacting with options can be done by pressing the rotary function dial. Depending on the selected option, pressing the dial will select the top entry in a list of settings displayed on the right side of the screen, the selected option will cycle a setting between set values or another menu will be opened/loaded.

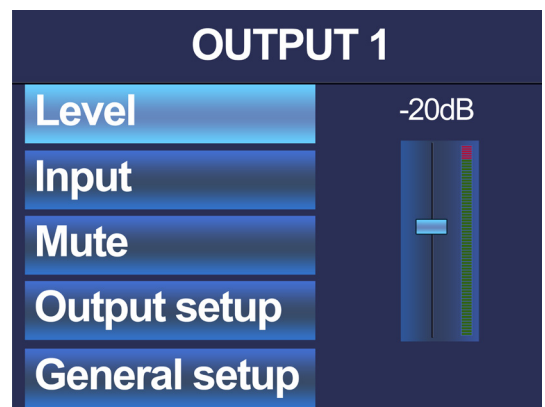

To return to the main menu the back option needs to be highlighted and the rotary dial needs to be pressed or the channel selection button of the currently selected output needs to be pressed once.

Level

The first option is the adjustment of the output level for the selected output. The output level which can be selected here is identical to the output level which can be adjusted on the main screen of the amplifier as described above. It can be adjusted within a range of 0 dB and -70 dB. After the selection has been made, returning to the settings menu is possible by confirming the selection through pressing the rotary function dial.

Input

The input which is linked to the selected output can be selected in this screen. Every input signal can be linked to every output channel, using the input selection matrix. Summed inputs for two sequential inputs can be selected too (E.g. Input 1+2). This can be useful when stereo inputs need to be patched to a mono output, or when the amplifier is used in bridge mode.

Mute

Muting will completely suppress the signal of the selected output. The mute indicator is shown in green when the output is unmuted and turns red when it is muted. Toggling between both states can be done by pressing the rotary function dial once.

Output setup

Output setup will lead you to a separate menu where the advanced configurations for the corresponding output can be made. The output setup menu is separately configurable for each of the outputs and includes configuration settings which generally will be made once for every setup or installation without having them adjusted frequently.

To return from the output setup menu back to the main menu, the "back" option at the bottom needs to be pressed.

SETUP OUTPUT 1	
Input List	1 = INPUT 1 2 = INPUT 2
Low pass	3 = INPUT 1+2 4 = INPUT 3
High pass	5 = INPUT 4 6 = INPUT 3+4
EQ settings	
Delay	

Output setup >> Input list

In the 'Input list', various inputs can be added, deleted and sorted. Only the inputs created here can be selected in the 'Input' list in the settings menu. This limits the options available.

In order to give different devices the same audio source, the given input has to be set according to the same numbering scheme. For example: Device A has a sound source connected to INPUT1, device B has the same sound source connected to INPUT4. In the Input list, the following is set:

Device A: 1 = INPUT 1

Device B: 1 = INPUT 4

Both devices are now playing the same audio when the same input list position is selected.

The SMA has two standard inputs where the SMQ has four standard inputs. When the optional ANI44XT module is installed, four extra Dante™ inputs are added.

Output setup >> Filters

Filters are frequently used in audio systems for different purposes. Some typical application examples are filtering noise or other unwanted signals from an audio signal and separating audio signals between different frequency ranges (crossover) when a 2-way (or more) system is used.

Because the characteristics of the required filter are strongly dependent of the application, the filter settings are made flexible and user configurable. Two filters are available. These filters are a configurable 'low pass' and 'high pass' filter. A 'Band pass' can be achieved combining a low and high pass filter. Characteristics which can be configured for the filters are:

Filter Type:	Selectable between Butterworth, Bessel, Linkwitz-Riley
Roll-off:	Selectable between 12 dB/Oct and 24 dB/Oct
Cutoff frequency:	Infinitely adjustable between 1 Hz and 22 kHz

The configuration of the desired filter can be made by selecting the required filter type in the column on the left side (Low pass or High pass). Subsequently the characteristics as described above can be adjusted on the right screen side. The

OUTPUT 1	
Input List	Type: OFF
Low pass	Roll-off: 24dB/Oct
High pass	Freq: 1000Hz
EQ settings	
Delay	BACK

currently selected parameter will be indicated in green and toggling between the different values is possible by pressing the rotary function dial. If the parameter is set to the desired value, scrolling to the next field can be done by turning the function dial. When adjusting the frequency, a 5 digit number is shown. The frequency value can be changed on a per digit base. The selected digit (clicking rotary dial) turns from orange to red and can then be changed by rotating the dial. the digit can be confirmed by pressing the rotary selection dial. Consecutive digits will increase when the maximum value has been reached.

After the desired frequency has been selected it can be confirmed by turning the function dial clockwise to the entire right side where the 'OK' word will appear. After pressing again the frequency is confirmed and the next characteristic can be adjusted. If all characteristics are set to the required value, select the 'BACK' option and you will be returned to the output setup menu.

RECOMMENDATION

When separating frequency ranges in two or more way systems, a Linkwitz-Riley filter with 24 dB / Oct roll-off is recommended between different frequency ranges. A high-pass Butterworth filter with 24 dB / Oct roll-off is suggested for elimination of low frequencies outside the frequency range of the loudspeaker, avoiding subsonic overload.

Output setup >> Equalizing

A parametric 7 bands equalizer will allow to cut or boost specific frequency ranges, helping to improve the sound and adapt it to acoustics of the location where its being used.

A standard configuration with center frequencies for 60 Hz, 150 Hz, 400 Hz, 1 kHz, 2.6 kHz, 6.8 kHz and 15 kHz with Q factor of 0.7 is pre-loaded. The center frequency of each band can be finely adjusted within a range of 10 Hz and 22 kHz, while the Q-factor can be adjusted within a range of 0.1 and 15 and the level of each band within a range of -15 dB and +15 dB.

A fader overview for the 7 bands equalizer will be shown after selecting the 'EQ settings' menu item. On top of the screen, the center frequencies for each band are shown with right under the currently selected equalizing level.

The selection of the corresponding band can be made by turning the rotary selection dial until the corresponding band is indicated in green and pressing it. Level adjustment can be done by turning the selection dial and confirmed by pressing it again. After this confirmation, another band can be selected and adjusted in identical way.

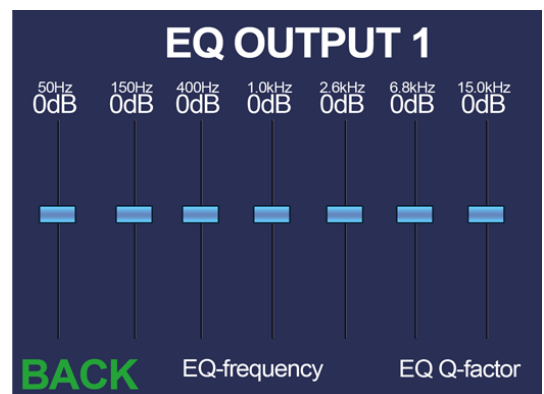

Adjustment of the Center frequencies and Q-factors can be done by selecting the corresponding 'EQ-frequency' and 'EQ Q-factor' buttons on the bottom of the screen. When selected, pop-up windows will appear where the corresponding adjustments for each band can be made. Adjustment of center frequencies can be made in similar way as described with filters above and Q-factors can be changed by selecting and turning clockwise (up) or counter-clockwise (down). This confirmation can be done by pressing again. After the required value for each band has been set, returning to the equalizer screen can be done by selecting the 'BACK' button.

The 'BACK' button in the left bottom corner of the equalizer screen can be selected and pressed to return back to the output setup menu or the channel selection button below the VU of the currently selected output can be used to return to the output setup menu..

Output setup >> Delay

This function enables to create a specific delay between the input and the output signal. This delay can be used for time alignment between different loudspeakers in one configuration. It is configurable in meters within a range of 0 meter and 12 meter with a resolution of 0.1 meter / step. Adjustments can be done by selecting it and turning the rotary selection dial. After the required delay is selected, it can be confirmed by pressing the rotary function dial.

Output setup >> Max level

This function will guarantee that the output level adjustable by the fader on the main screen (which is accessible through user level access) will never exceed a certain value as configured. This gives protection for non-authorized persons when increasing the volume. It can be adjusted within a range of 0 dB (no restrictions) and -70 dB.

The screen shows a fader with the configured maximum output level indicated above it. When selected, the fader including the currently configured maximum output level will turn green and the level is adjustable by turning the rotary function dial. The fader will slide up or down and after the desired value has been selected, it can be confirmed by pressing the rotary function dial.

Output setup >> Standby

When no signal is detected for a corresponding channel, it will be switched automatically to standby mode. The delay time between the absence of a signal and switching to standby mode can be selected in this screen. It can be disabled (never) or adjusted within a range of 1 to 10 minutes. The power consumption will decrease when one or more channels are switched to standby.

Output setup >> Limiter

The output level for each channel can be limited to a certain power. This is very useful when the output power of the amplifier is greater than the maximum power handling of the connected loudspeaker. Independently of a rising level of the applied input signal, the output power will be always limited to the set value. This way, loudspeaker damage due to power overload can be avoided when this setting is made correctly.

SETUP OUTPUT 1	
EQ settings	
Delay	500 Watt at 4Ω
Max Level	250 Watt at 8Ω
Standby	
Limiter	

Output setup >> Phase reverse

The phase reverse button essentially flips the waveform on its head. The positive oscillations are now negative and vice/versa. This is a quick and easy way to check the phase of your mics and often a simple solution to a phase problem.

Output setup >> Dynamic bass

Dynamic bass will make a correction depending of the level (volume) in the low frequencies.

This correction will make that music will sound warm and detailed (with true reproduction of low frequencies) at low volumes, but with increasing level (volume) the low frequencies will be weakened. This will result in less distortion due to reduced low frequencies at high volumes, allowing the loudspeaker to handle higher sound pressure levels with less distortion.

It can be switched ON and OFF, whereby OFF means that dynamic bass is disabled and ON means that a level dependent correction in the low frequencies is made.

Output setup >> Bridge

Pairs of two subsequent channels can be bridged with merged power of both channels obtaining one single channel with double output power. The bridged pairs should always be subsequent channels (OUT 1+OUT2 & OUT3+OUT4 for SMQ). When bridging two channels, only one fader for the bridged channel will be shown in the main screen.

Bridging can be switched ON and OFF, whereby OFF means that all channels are functioning completely separately and ON means that two channels are bridged.

For SMQ Amplifiers (four channels), three channel configurations can be made whereby two channels are functioning separately and two channels are bridged. These configurations are typical for applications where stereo top speakers are used in combination with a single bass cabinet.

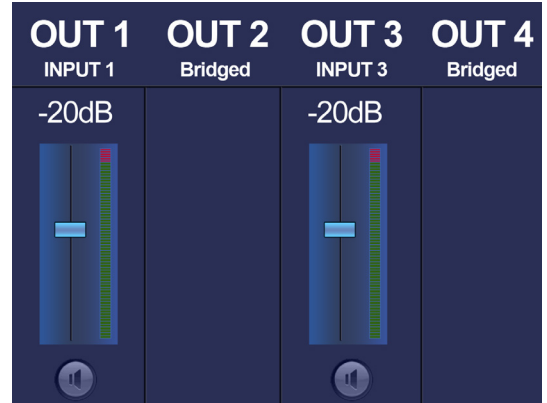

Output setup >> SPKR preset

Loudspeaker and total system (set) configurations can be uploaded to the amplifier. Every preset is made and optimized for one specific loudspeaker or system. This window will indicate if any preset is currently loaded. Presets which are meant for others than the connected loudspeakers may affect the performance and sound quality in negative way, while not providing optimal protection.

Clearing of the currently loaded presets can be done by selecting this option and pressing clear. Please note that other configurations for the corresponding channel (Eg. filters, equalizing, ...) which are separately made from the preset will remain unchanged. When a total system configuration (set solution *.SOL) is currently loaded and cleared, configurations on other outputs which are part of this preset will be cleared too.

General setup

From the settings menu the general setup will lead you to a separate menu where some global configuration settings for the amplifier can be made.

General setup >> Input gain

The gain for each individual input can be set in this screen between a range of -16.5 dB and +30.75 dB, -27dB and +30.75 dB for SMQ1250. After scrolling and selecting the right input, gain can be adjusted through turning the rotary selection dial. Level indicators are shown on the right side of the display indicating the correct set gain level. Three colour indicators (green, orange and red) will illuminate at different levels and give feedback about the currently set gain. A correct regulation of the input gain is achieved when the green indicator is frequently blinking, the yellow indicator is only illuminated at the peaks (-6 dB) and the red indicator blinks rarely or not. When the red indicator blinks frequently, the input is over driven and the gain needs to be reduced. When the green indicator blinks rarely or not, no input signal is detected

GENERAL SETUP	
Input gain	Input 1: 18.75dB
TouchLink	Input 2: 25.50dB
Admin pass	Input 3: 5.25dB
User pass	Input4: 30.75dB
LCD	BACK

General setup >> TouchLink

The TouchLink feature is only available in the SMA/SMQ amplifier when the ANI44XT module is installed. When installed, the TouchLink menu will appear. For each output, a TouchLink zone number can be assigned. Devices with the identical TouchLink zone number will act as one virtual zone, meaning they will follow volume and input changes within the same TouchLink zone. A TouchLink volume offset (up to -70 dB) allows to set the volume balance between various devices. A TouchLink priority number allows to switch to an alternative input source when a TouchLink priority is announced and also allow specific priority volume offsets. TouchLink priority announcements are made through TouchLink priority compatible devices.

General setup >> Address

In this screen the device address can be changed. The currently selected address will be shown and the adjusting digit can be selected (turns red) and confirmed by turning and pressing the rotary selection dial. Consecutive digits will increase when the maximum value has been reached. After the desired Address has been selected it can be confirmed by pressing (turns red) and turning the function dial clockwise to the entire right side where the 'OK' word will appear. After pressing again the Address is confirmed.

General setup >> Passwords

Password protection is provided in two different levels, administrator and user level. Administrator level has full access to all available functions of the amplifier while user level only can access the volume of the amplifier. Both passwords consist of a 4 digit code which is intended to be different. The displayed passwords are used when controlling the SMAQ with an ANI44xT installed using AUDAC Touch™ 2.

In standard configuration, both passwords are set to '0000'. In this case, full access is given without requiring any password. If either the configured user or administrator password is different from '0000', a password will be requested before access to the relevant functions is provided.

The configuration of the selected password can be made by selecting Admin pass or User pass in the column on the left side. The currently selected password will be shown and the adjusting digit can be selected (turns red) and confirmed by turning and pressing the rotary selection dial. Consecutive digits will increase when the maximum value has been reached. After the desired password has been selected it can be confirmed by pressing (turns red) and turning the function dial clockwise to the entire right side where the 'OK' word will appear. After pressing again the password is confirmed.

General setup >> Admin PIN

In this screen the PIN of the admin can be changed. The currently selected PIN will be shown and the adjusting digit can be selected (turns red) and confirmed by turning and pressing the rotary selection dial. Consecutive digits will increase when the maximum value has been reached. After the desired PIN has been selected it can be confirmed by pressing (turns red) and turning the function dial clockwise to the entire right side where the 'OK' word will appear. After pressing again the PIN is confirmed.

General setup >> User PIN

In this screen the PIN of a user can be changed. The currently selected PIN will be shown and the adjusting digit can be selected (turns red) and confirmed by turning and pressing the rotary selection dial. Consecutive digits will increase when the maximum value has been reached. After the desired PIN has been selected it can be confirmed by pressing (turns red) and turning the function dial clockwise to the entire right side where the 'OK' word will appear. After pressing again the PIN is confirmed.

General setup >> LCD

Adjustment for the LCD settings can be made in this screen. The brightness of the LCD can be adjusted within a range of 10% to 100% (standard is 80%). Adjusting the LCD brightness can be convenient when the device is placed in an environment with very low or very high ambient light. Hereby the clarity of the LCD can be adjusted in such way being clearly but unobtrusive.

The backlight off time can be adjusted within a period of never (always on) up to 120 minutes in steps of 5 minutes, making the backlight of the LCD automatically turn off after the set time.

General setup >> USB

USB will lead you to a separate sub-menu where all settings and options using USB functions can be found. A FAT32 formatted USB flash drive should be inserted to the USB slot on the front of the amplifier.

General setup >> USB >> Save

The complete configuration of the amplifier can be saved to a file by using the 'save' button. This way, a complete backup for system recovery can be made. This provides a great advantage for re-loading a previous configuration and duplicating the configuration to other amplifiers. A window will appear whereby the desired filename for the configuration can be selected and the system backup will be saved as ..\AUDAC\SETTINGS\FILENAME.SET

General setup >> USB >> Load

Different types of configuration files can be loaded into the amplifier, such as loudspeaker presets (*.SPF), complete set solution configurations (*.SOL) and system backups (*.SET). Each of the configuration files have their own filetype and will be loaded in a different way. When pressing the load button, the root folder of the USB drive is displayed. Browsing through folders is possible through turning the rotary dial, lower folders can be easily accessed by selecting them while both top options allow to browse up or to the root of the inserted USB drive. Additional comments about system configurations are shown on the right side of the browse window. After the desired file has been found, it can be loaded by selecting it.

Speaker presets are files in *.SPF format which are prepared and provided by AUDAC and containing all parameters for optimal performance and protection of the corresponding loudspeaker. When a *.SPF file is loaded, the amplifier will recognize the file type and show a popup window wherein one, none, some or all channels can be selected on which this file should be applied (the selected output is connected to the loudspeaker). After the selected channels are selected, the 'load settings' option will load the *.SPF settings to the selected channels. All previously made EQ settings are removed from the selected outputs when an *.SPF file is loaded.

Complete system configurations (set solutions) are files in *.SOL format which are prepared and provided by AUDAC. These files contain parameters for a complete configuration consisting of multiple (different types of) loudspeakers, such as a combination of loudspeaker cabinets with a bass cabinet, ... These configuration files also contain information about connected channels, bridging, filtering, etc. When a *.SOL file is selected, it will be immediately loaded without requiring selection of the channels where it should apply to Since this information is already included into the *.SOL file. All previously made EQ and filter settings are removed when an *.SOL file is loaded.

System backups are files in *.SET format. When a system backup is made using the 'save' action as shown above, it will be saved as a *.SET file which can be re-loaded in similar way as a *.SOL file. It will be immediately loaded without the user to select the outputs it should overwrite.

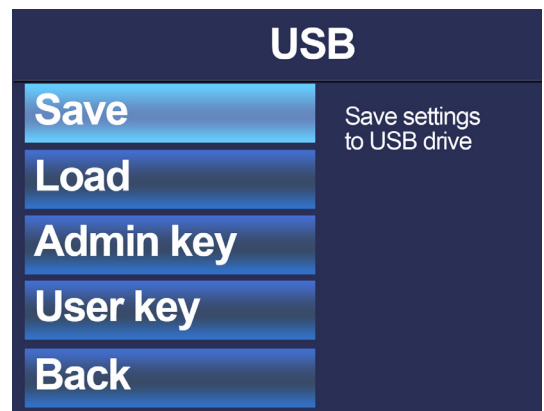

General setup >> USB >> Key

A USB key with both administrator and user level access can be created when selecting the corresponding buttons. A file containing the configured password information will be stored to the inserted medium, providing instant access to the functions when the medium is inserted. This will allow instant and easy access in any circumstance and will also eliminate the possibility that someone's peeking the password.

General setup >> Info

The info screen gives an overview of the amplifier model and the software version which it is currently running.

General setup >> ANI Info

The ANI info screen gives an overview of the ANI name, ANI model, firmware version and, mac address and network

General setup >> Temperature

The temperature screen indicates the current operating temperature for each individual amplifier channel.

General setup >> Factory reset

Factory reset will recall all settings to factory defaults and all previously made settings and configurations will be lost.

After pressing the factory reset button the user will be asked to confirm that they do, in fact, want to reset the SMA/Q. When confirmed, all settings will be lost.

Lock

When selected, the amplifier will be locked and the configured password will be required before any access is given to the user interface of the amplifier.

Technical specifications



RMS Output Power (1kHz, THD 1%)	SMA350	4 Ohm Stereo	2 x 350 Watt
		8 Ohm Stereo	2 x 220 Watt
		8 Ohm Bridge	700 Watt
	SMA500	4 Ohm Stereo	2 X 500 Watt
		8 Ohm Stereo	2 x 300 Watt
		8 Ohm Bridge	1000 Watt
	SMA750	4 Ohm Stereo	2 x 750 Watt
		8 Ohm Stereo	2 x 380 Watt
		8 Ohm Bridge	1500 Watt
	SMQ350	4 Ohm Stereo	4 x 350 Watt
		8 Ohm Stereo	4 x 220 Watt
		8 Ohm Bridge	2 x 700 Watt
	SMQ500	4 Ohm Stereo	4 x 500 Watt
		8 Ohm Stereo	4 x 300 Watt
		8 Ohm Bridge	2 x 1000 Watt
	SMQ750	4 Ohm Stereo	4 x 750 Watt
		8 Ohm Stereo	4 x 380 Watt
		8 Ohm Bridge	2 x 1500 Watt
	SMQ1250	4 Ohm Stereo	4 x 1250 Watt
		8 Ohm Stereo	4 x 630 Watt
		8 Ohm Bridge	2 x 2500 Watt
Frequency response			20 Hz - 20 kHz
Signal to Noise Ratio			>95 dB
Total Harmonic Distortion + Noise			< 0.05%
Common Mode Rejection			70 dB
Crosstalk			> 70 dB
Inputs	Type		Balanced Line
	Connectors		Female XLR Input
			3-pin terminal block ~ 3.81mm
	Impedance		10 k Ohm balanced
Sensitivity		-30 dB ~ +5 dB	
Output	Type		Loudspeaker Output
	Connectors		SpeakON compatible
			2-pin terminal block ~ 5.08 mm
Controls			DSP configuration via front panel
			RS-232
Indicators			Power
			Protect
			Peak

			- 20 dB
			Signal
Protection			DC-Short Circuit
			Over heating
			Over load
			Limiter
Cooling system			Temperature controlled fan
Amplifier technology			Class-D
Power Supply	Type		Switching mode
	Range		230 ~ 240 V AC / 50 Hz
			Voltage selector switch
			100 ~ 120 V AC / 60 Hz
			(Not applicable for SMQ1250)
Power consumption	Standby	SMA350/500/750	25 Watt
		SMQ350/500/750/1250	35 Watt
	Idle	SMA350	37 Watt
		SMA500	38 Watt
		SMA750	40 Watt
		SMQ350	56 Watt
		SMQ500	57 Watt
		SMQ750	60 Watt
		SMQ1250	68 Watt
	1/8 rated power	SMA350	145 Watt
		SMA500	182 Watt
		SMA750	262 Watt
		SMQ350	272 Watt
		SMQ500	345 Watt
		SMQ750	503 Watt
		SMQ1250	816 Watt
	1/3 rated power	SMA350	305 Watt
		SMA500	416 Watt
		SMA750	624 Watt
		SMQ350	592 Watt
		SMQ500	813 Watt
		SMQ750	1227 Watt
		SMQ1250	2012 Watt
Optional accessories			ANI44XT



Discover more on audac.eu